

# Let's make pancakes

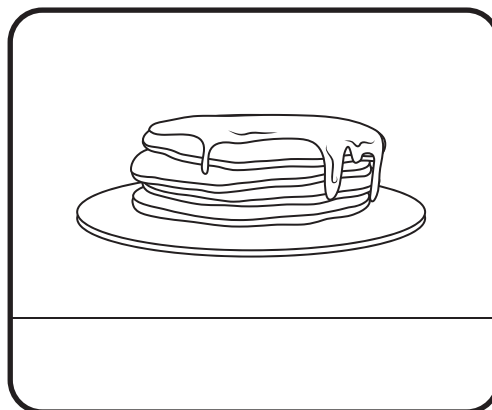
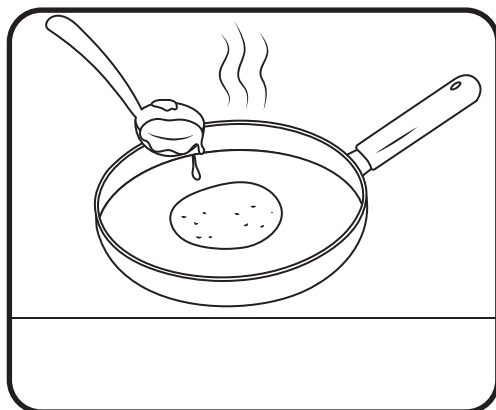
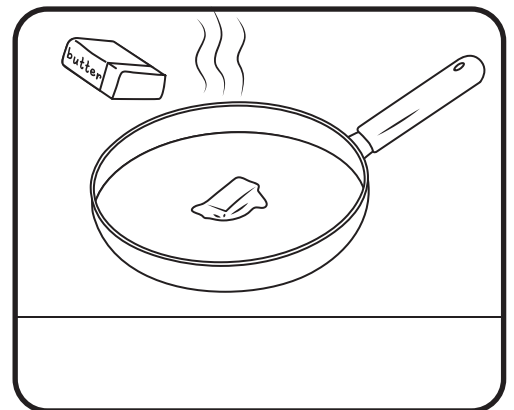
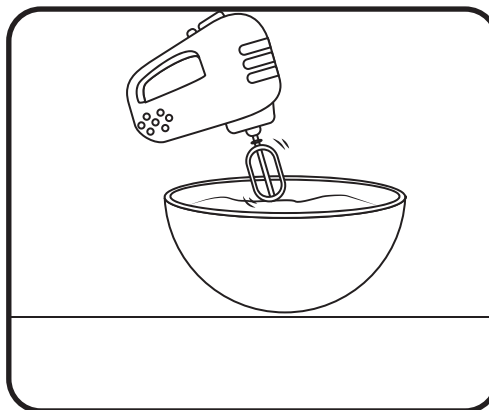
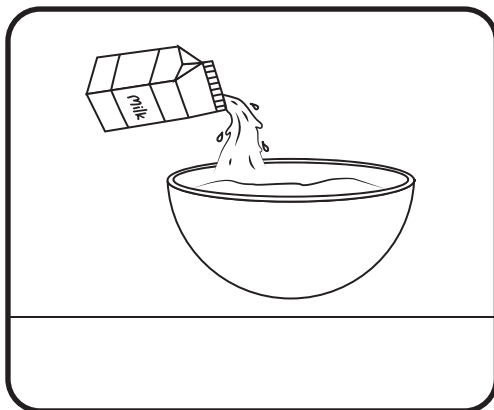
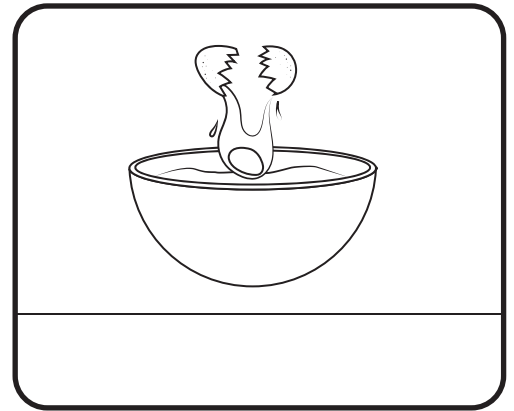
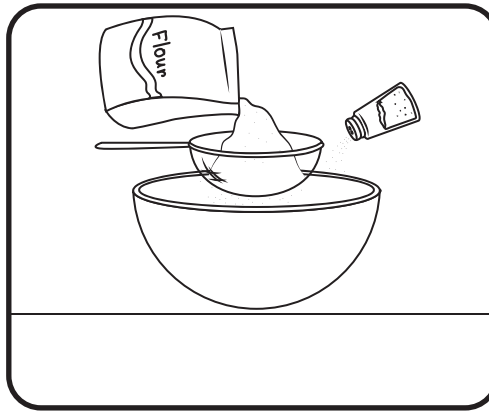

1. Pour in some milk
2. whisk the batter mixture until it is smooth
3. Cook in a frying pan until lightly browned.
4. Leave to cool and enjoy
5. Collect all your ingredients
6. Sift the flour into a bowl and add a pinch of salt
7. Melt some butter into a hot pan
8. Add an egg to the flour

# Match the words to correct pictures

Egg



Milk

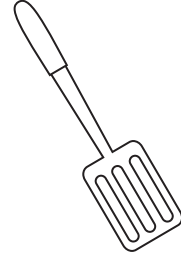

Frying pan



Pancakes

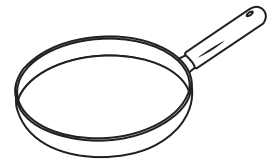

Flour



Butter

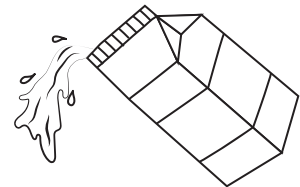

Salt

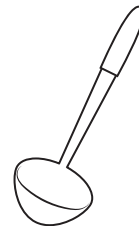

Dipper



Spatula



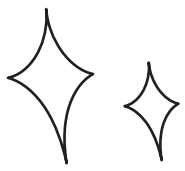

# Unscramble words

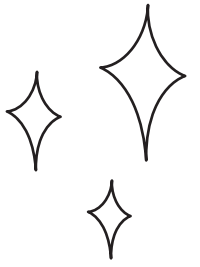

napacke

---

nap

---

wlbo

---

uprys

---

gruas

---

sgeg

---

orulf

---

kilm

---

Stal

---

rtubet

---

nopso

---

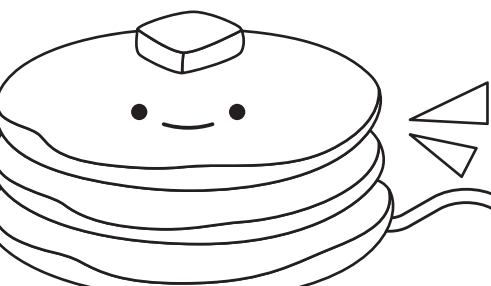

# Design your own pancake

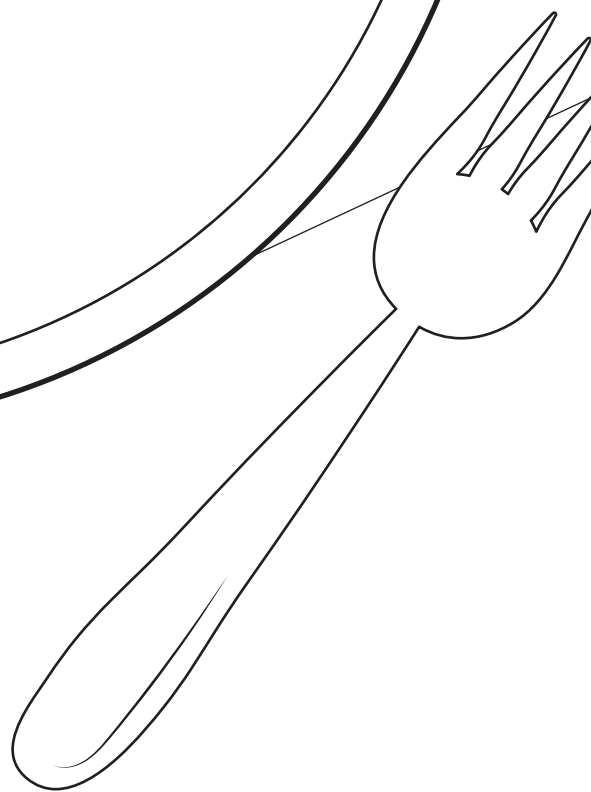
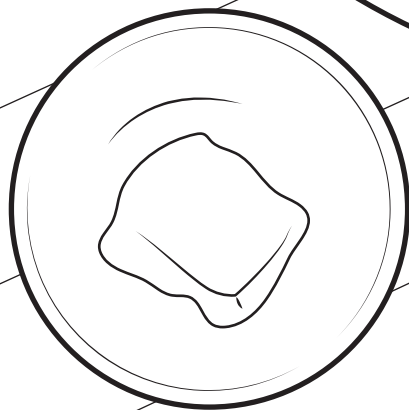
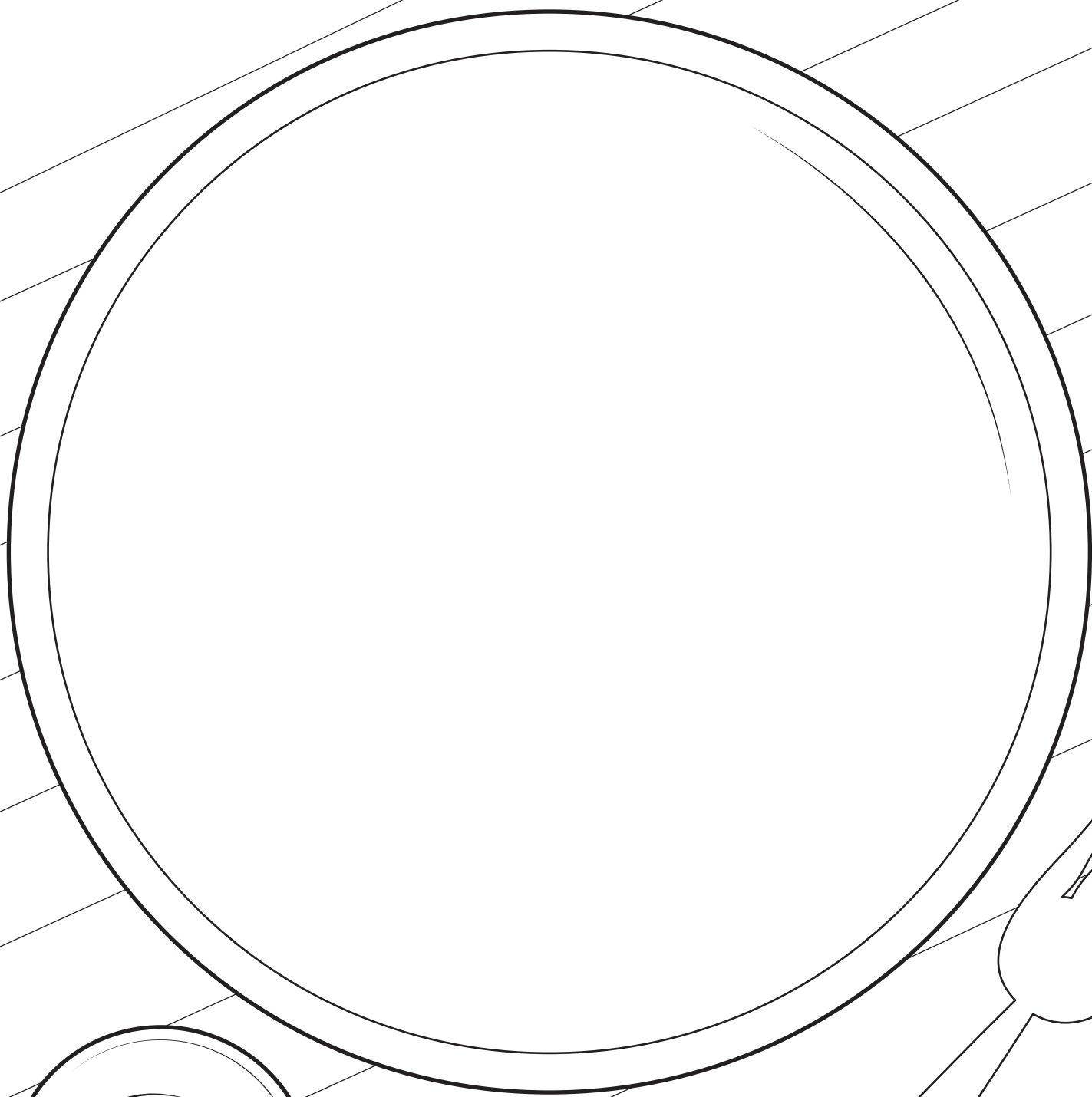

# Pancake Wordsearch

r	u	o	l	f	l	m	j	z	g
c	y	k	x	i	r	j	k	g	p
m	a	n	m	k	z	a	e	e	a
f	r	y	i	n	g	p	a	n	n
b	n	e	k	p	s	o	l	j	c
i	u	l	p	a	k	o	u	m	a
o	i	t	l	p	m	k	t	b	k
m	t	t	t	w	i	m	a	s	e
c	l	y	t	e	i	d	p	r	s
z	k	b	z	t	r	b	s	c	c

---

---

---

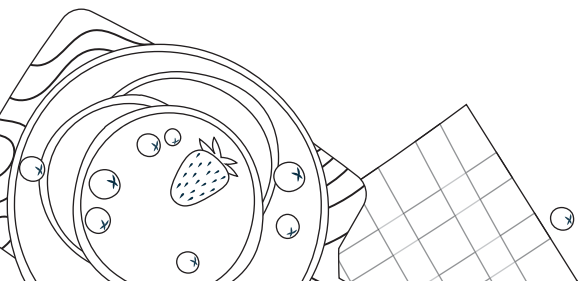

# Pancake toppings

Write a description of each topping

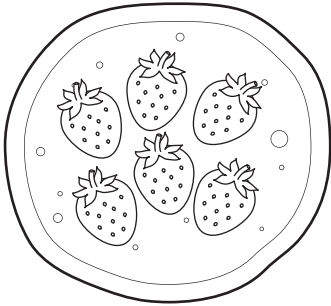

---

---

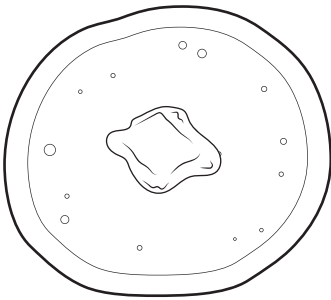

---

---

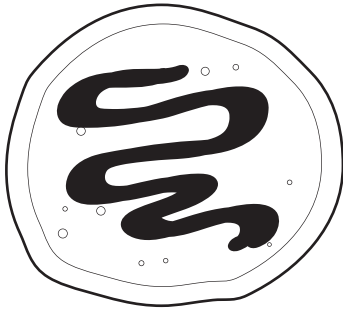

---

---

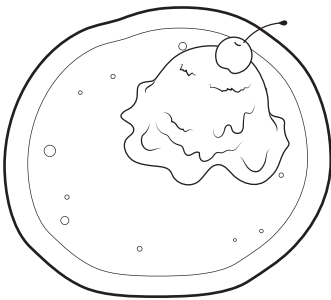

---

---

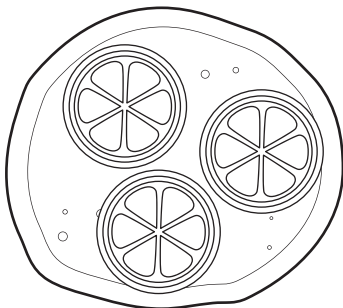

---

---



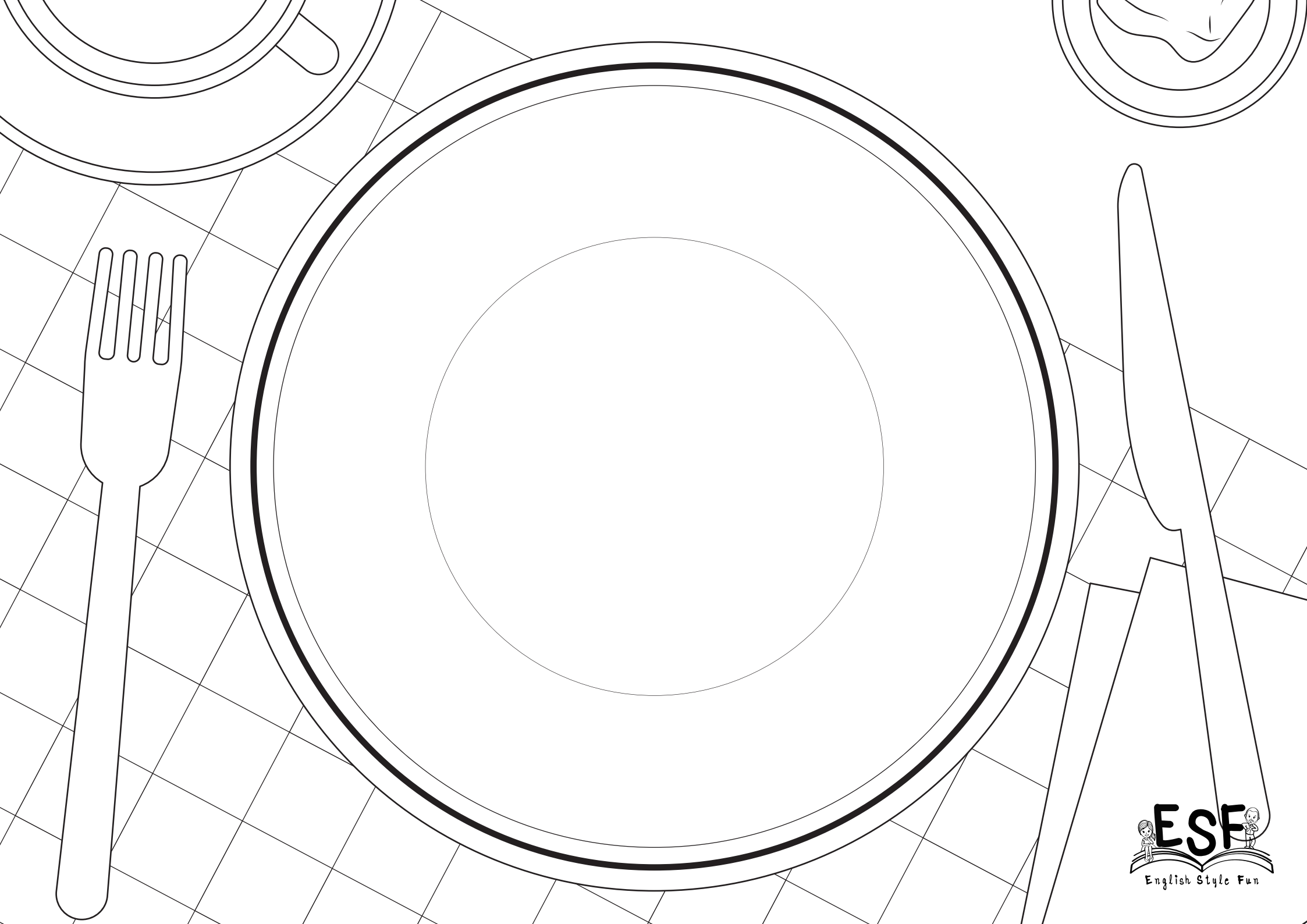



**Pancake**

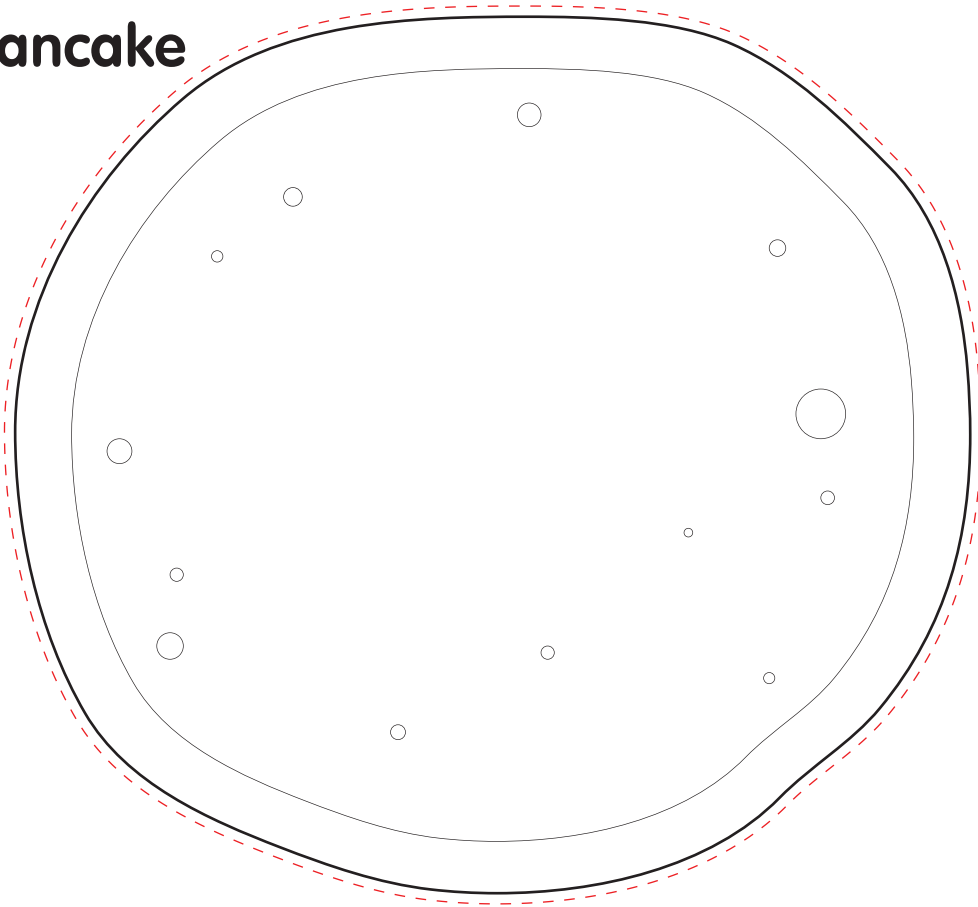

**Pancake**

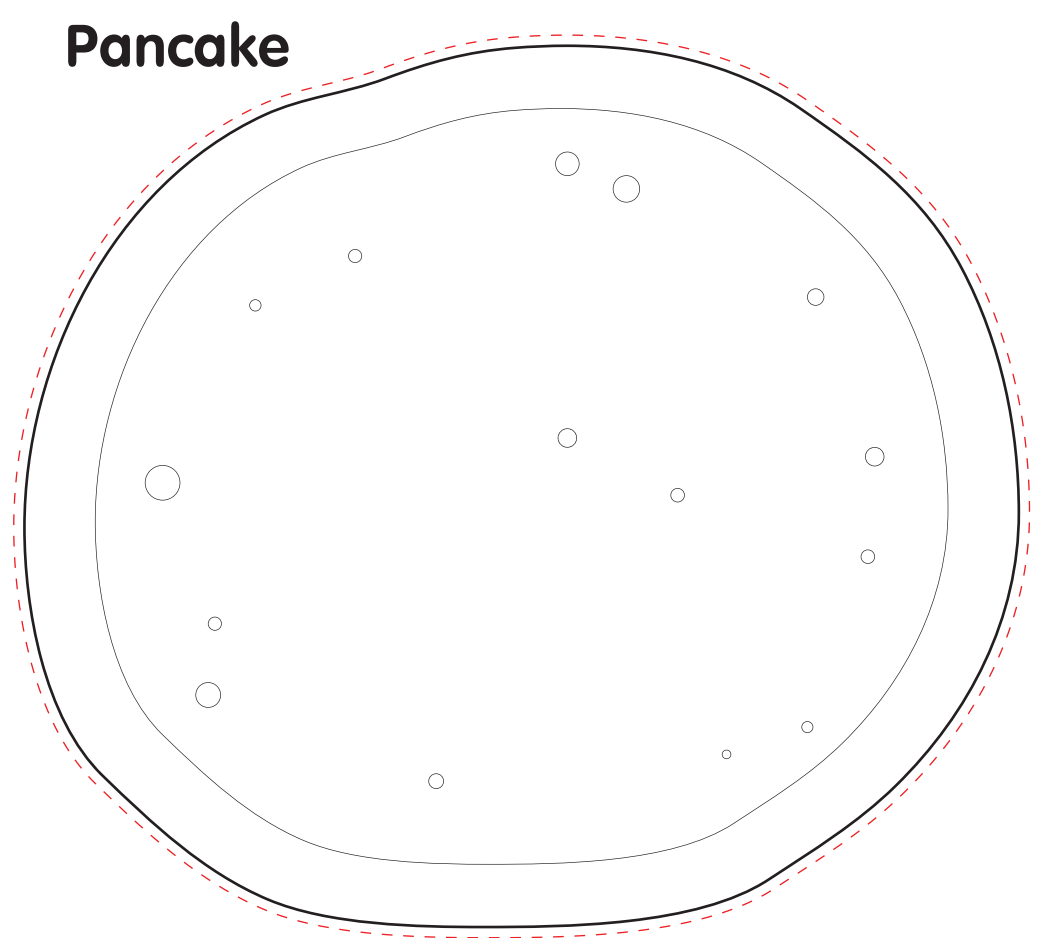

**Strawberries**

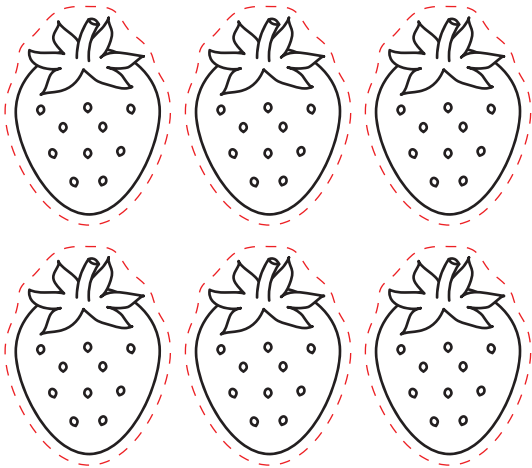

**Blueberries**

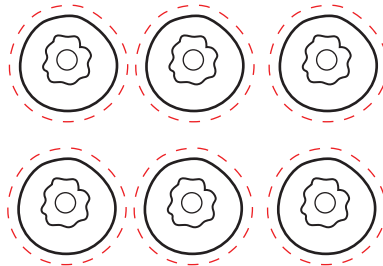

**Banana slices**

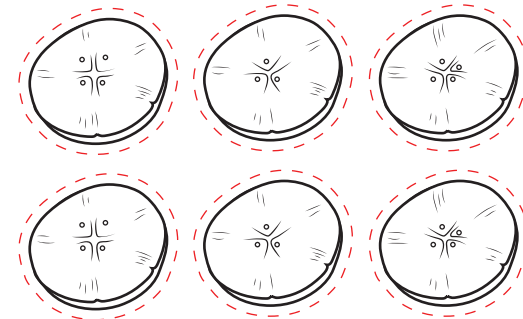

**Pancake**

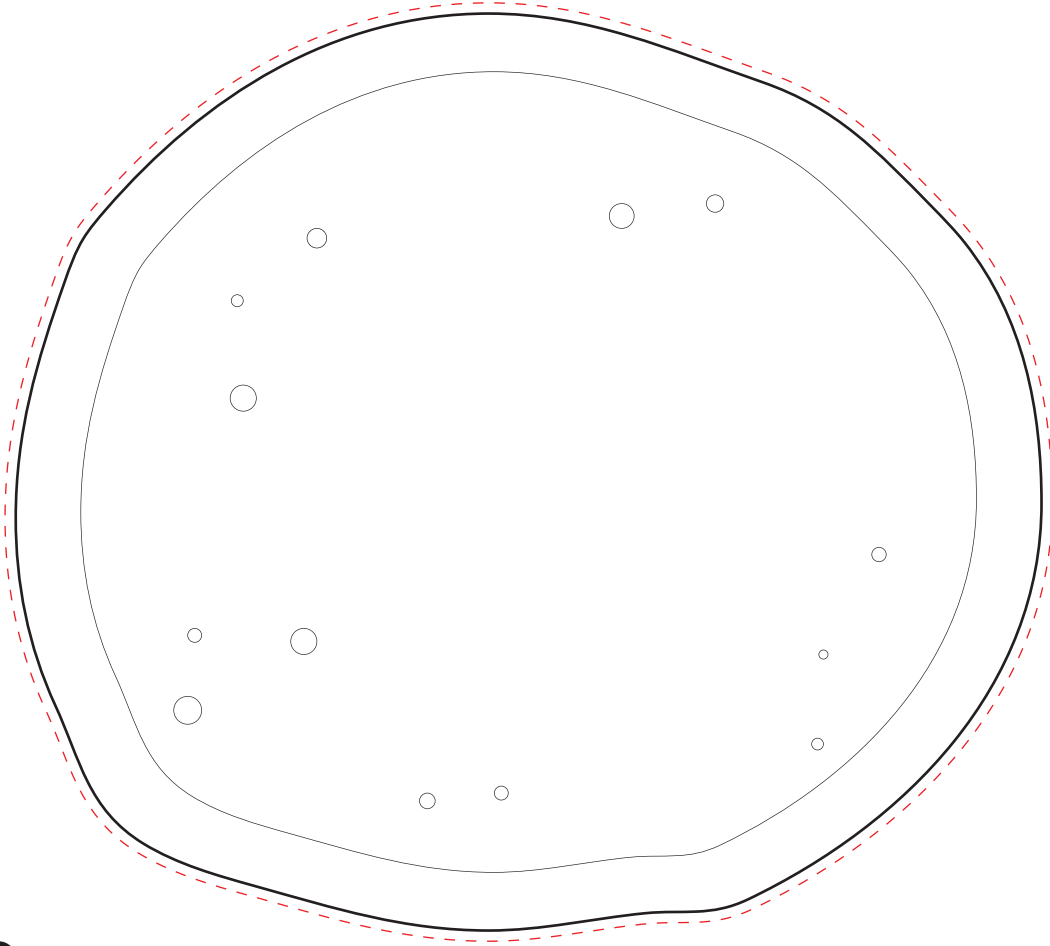

**Maple Syrup**

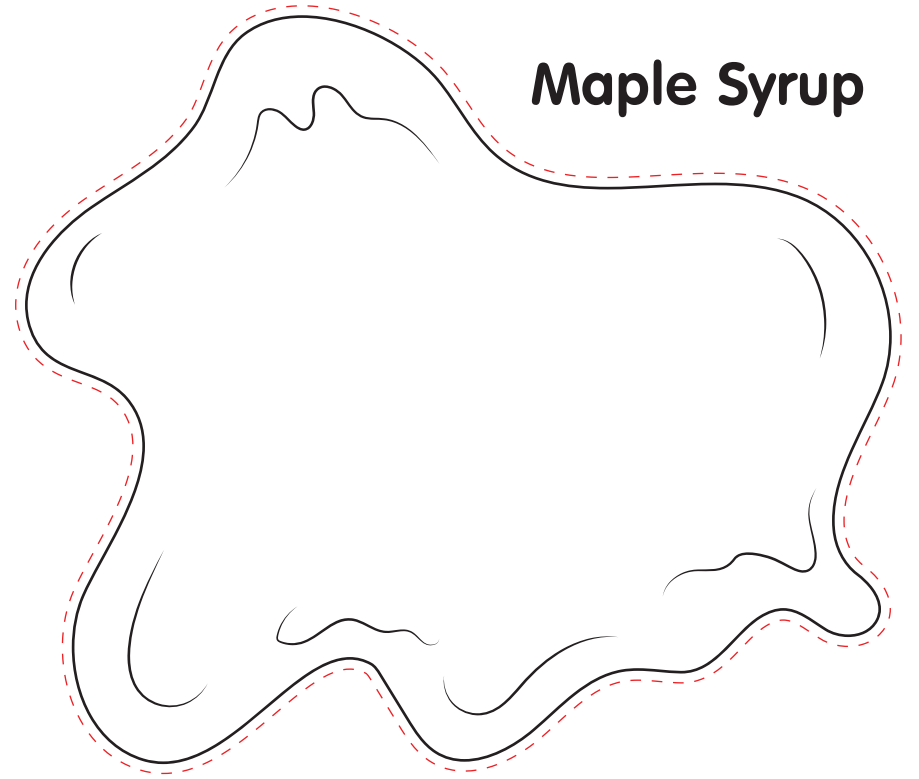

**Oranges**

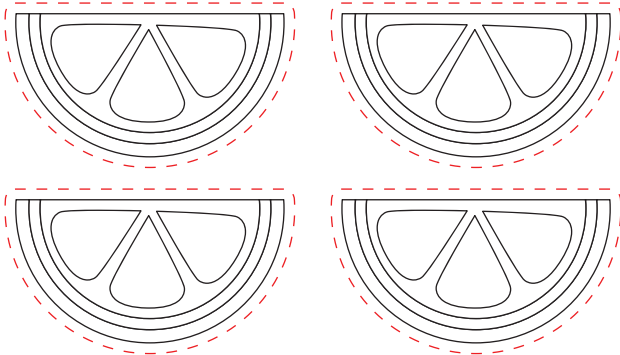

**Butter**

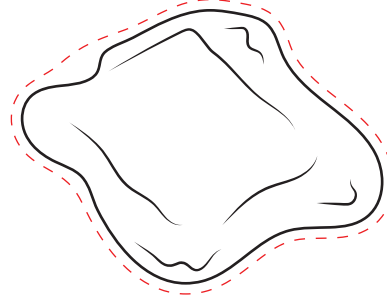

**Whipped cream**

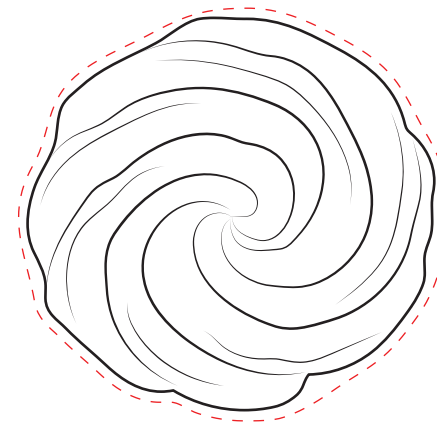

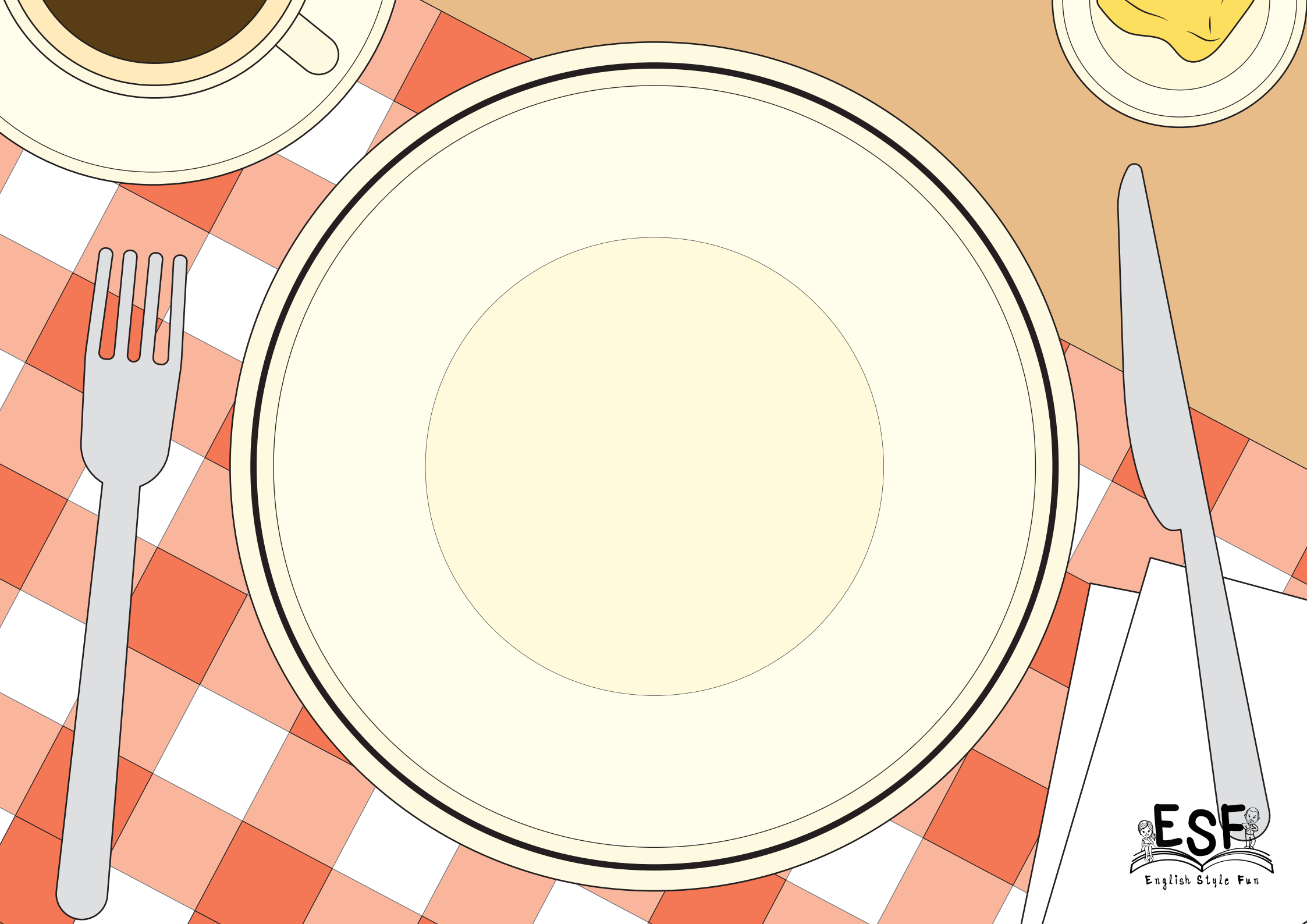

Pancake

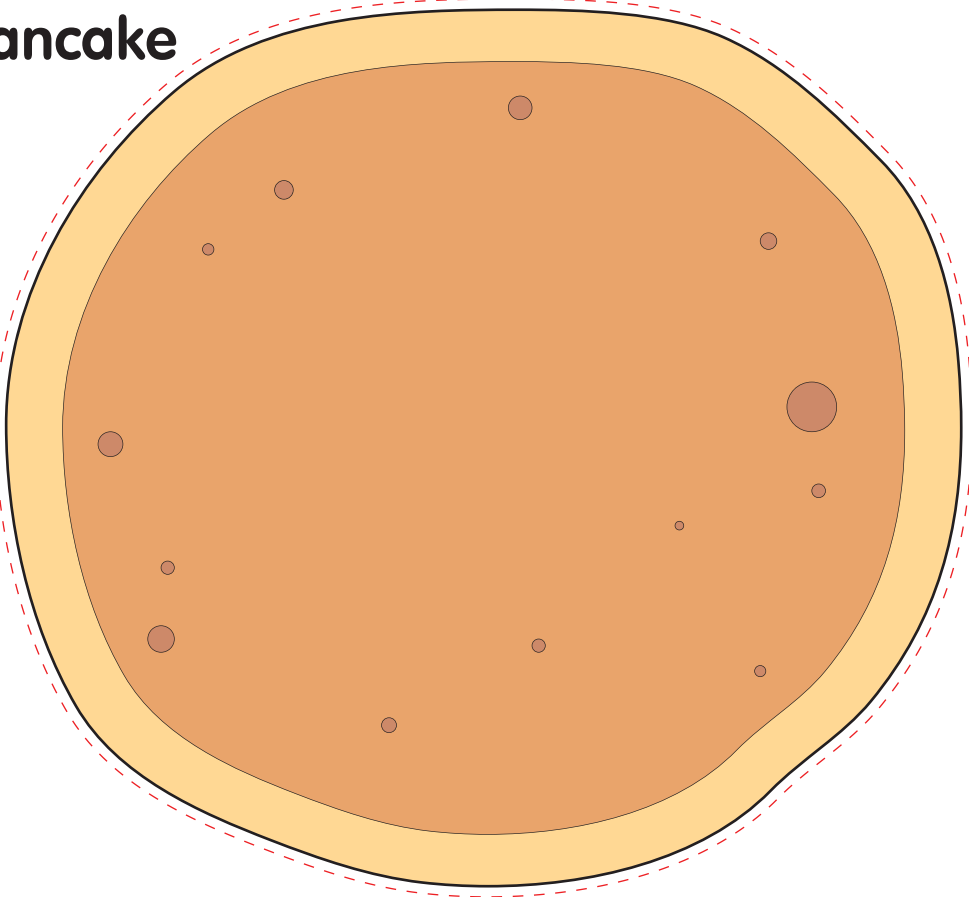

Pancake

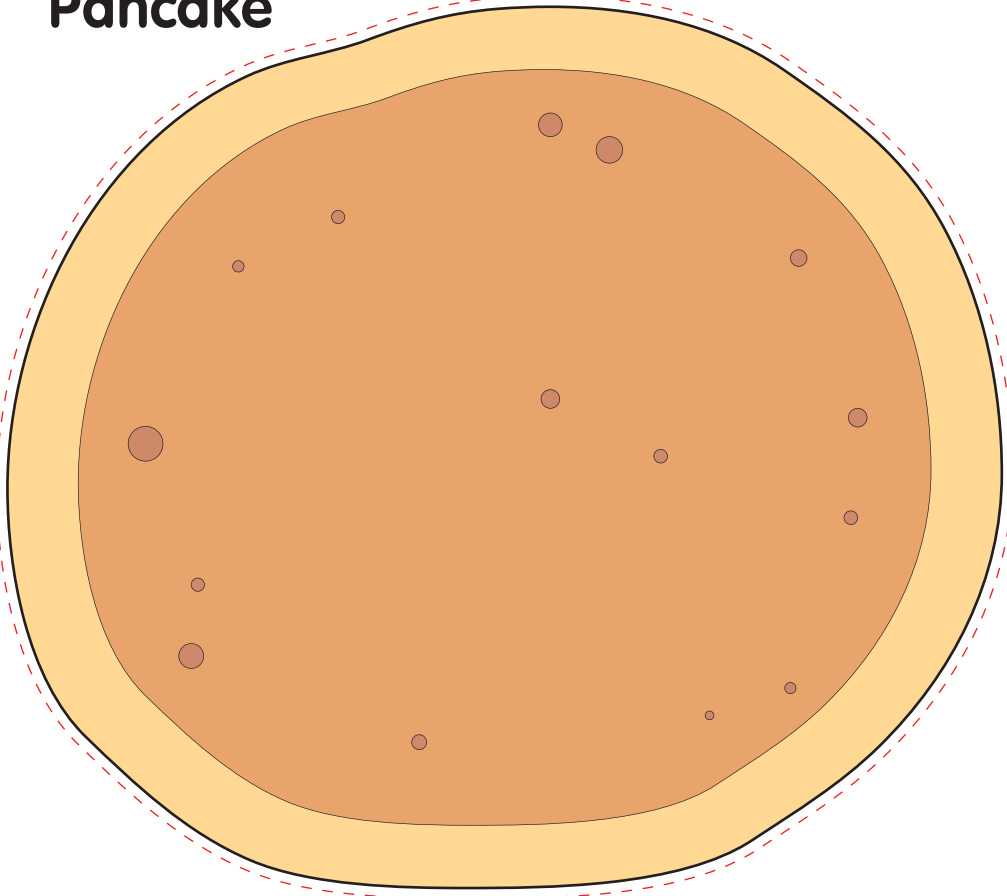

Strawberries

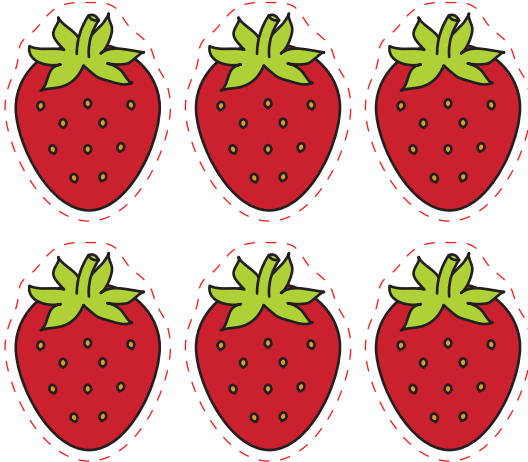

Blueberries

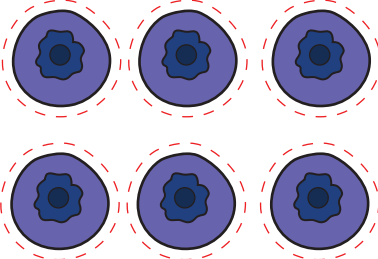

Banana slices

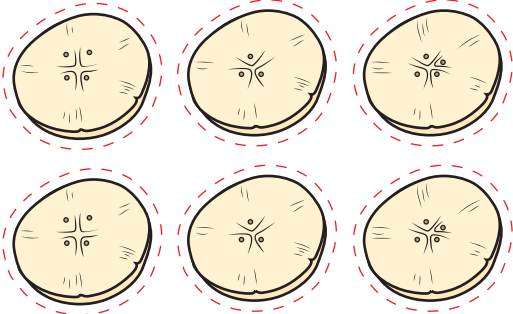

**Pancake**

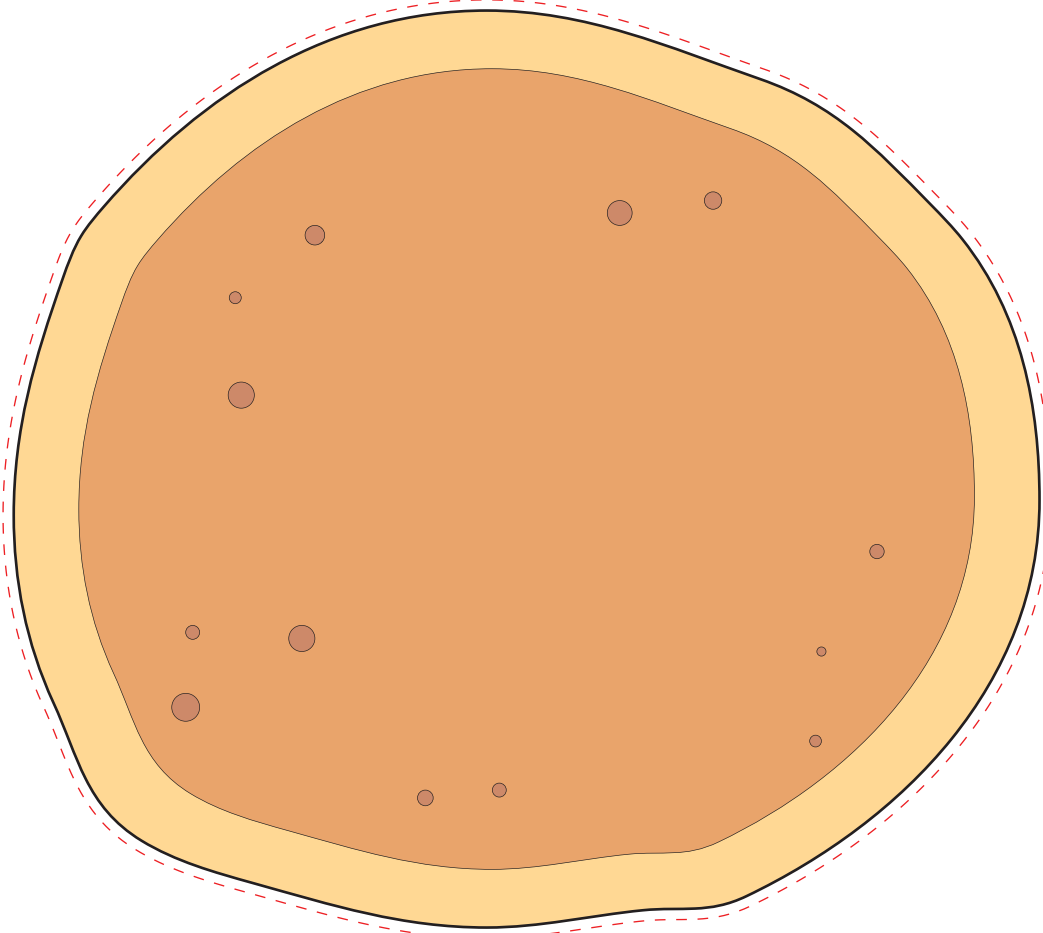

**Maple Syrup**

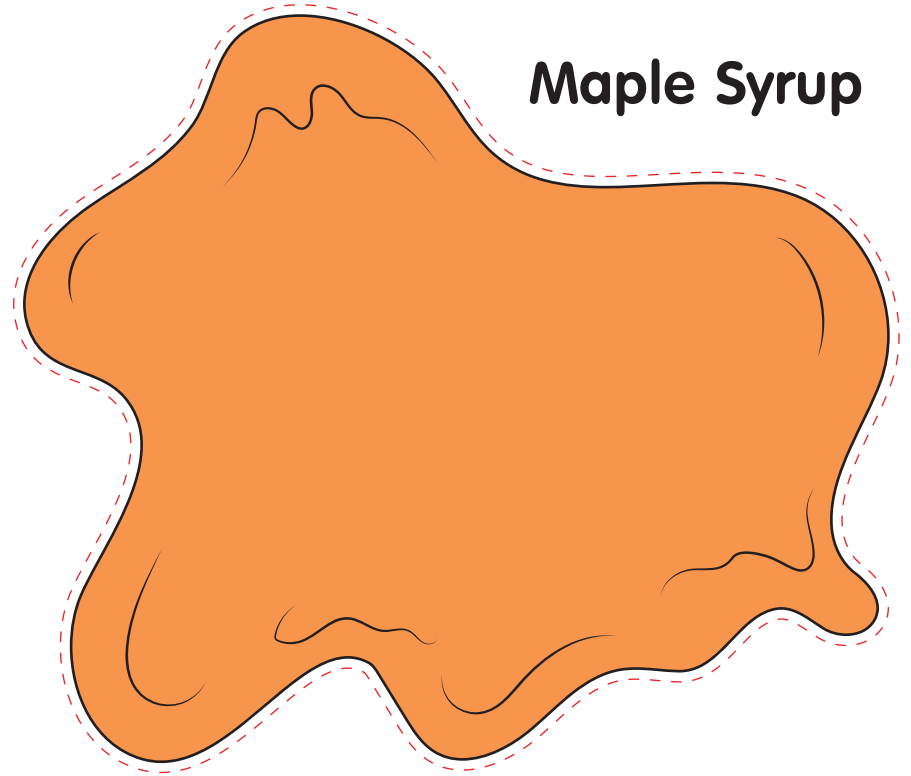

**Oranges**

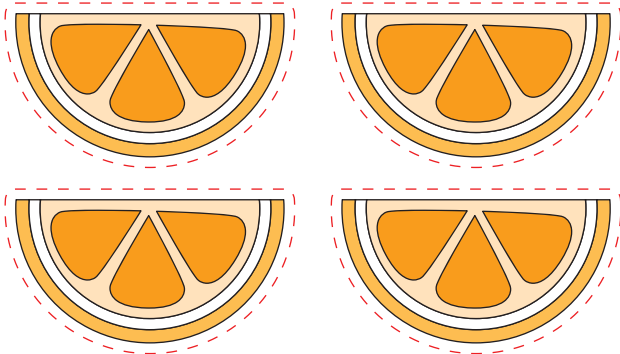

**Butter**

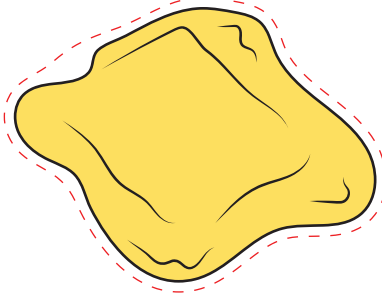

**Whipped cream**

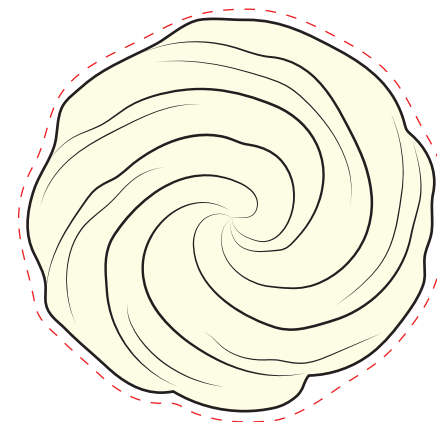

# Let's make pancakes

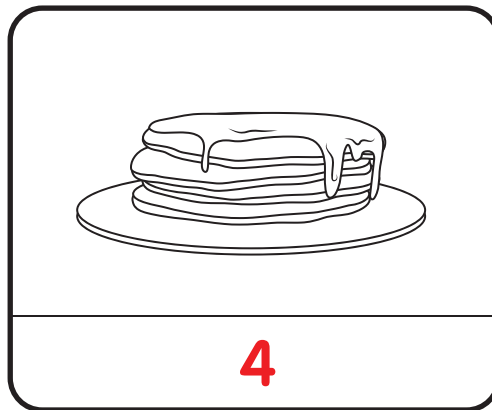
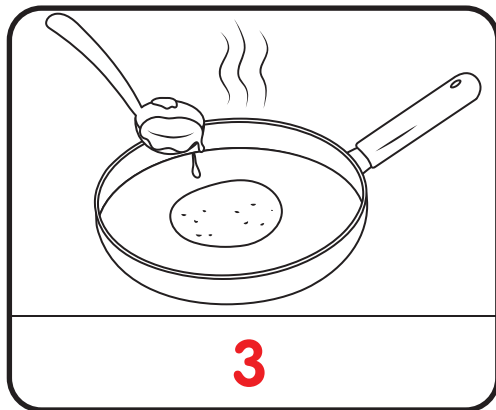
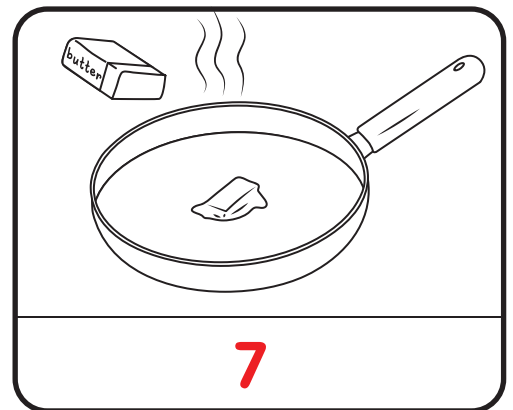
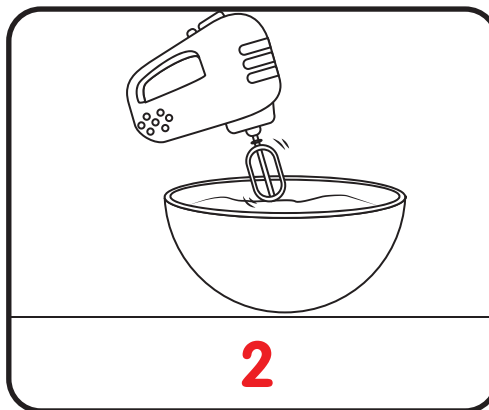
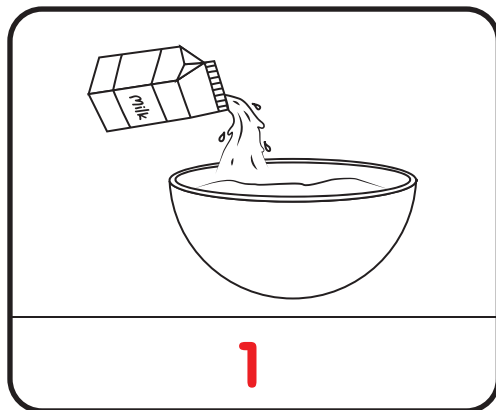
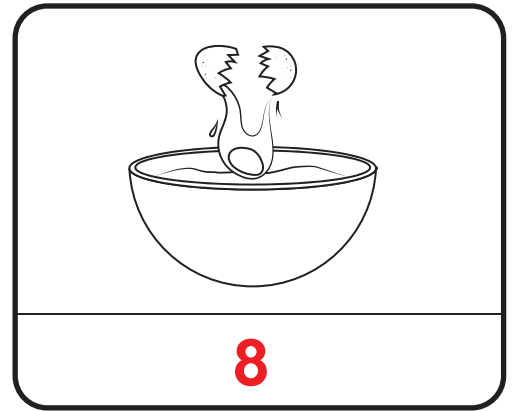
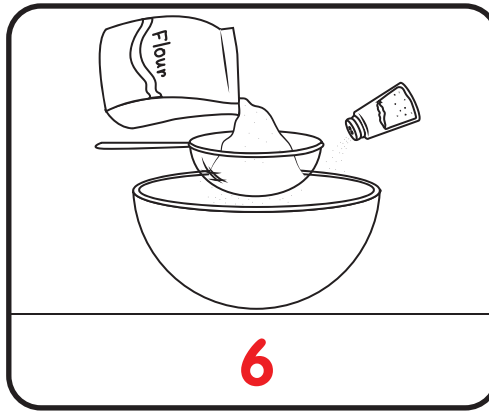

1. Pour in some milk

2. whisk the batter mixture until it is smooth

3. Cook in a frying pan until lightly browned.

4. Leave to cool and enjoy

5. Collect all your ingredients

6. Sift the flour into a bowl and add a pinch of salt

7. Melt some butter into a hot pan

8. Add an egg to the flour

# Match the words to correct pictures

Egg

Milk

Frying pan

Pancakes

Flour

Butter

Salt

Dipper

Spatula

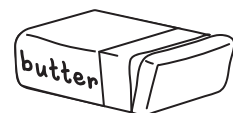
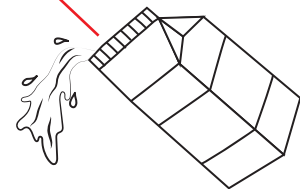
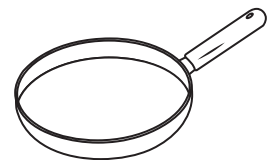
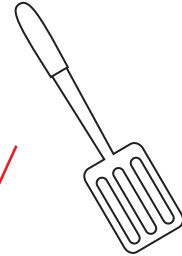

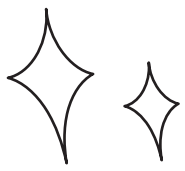

# Unscramble words

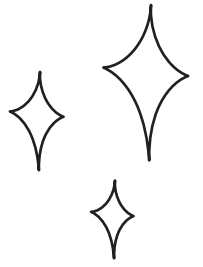

napacke

pancake

nap

pan

wlbo

bowl

uprys

syrup

gruas

sugar

sgeg

eggs

orulf

flour

kilm

milk

Stal

salt

rtubet

butter

nopso

spoon

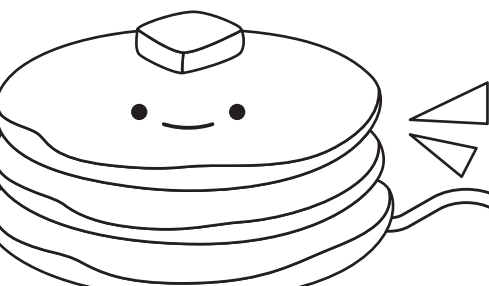



# Pancake Wordsearch

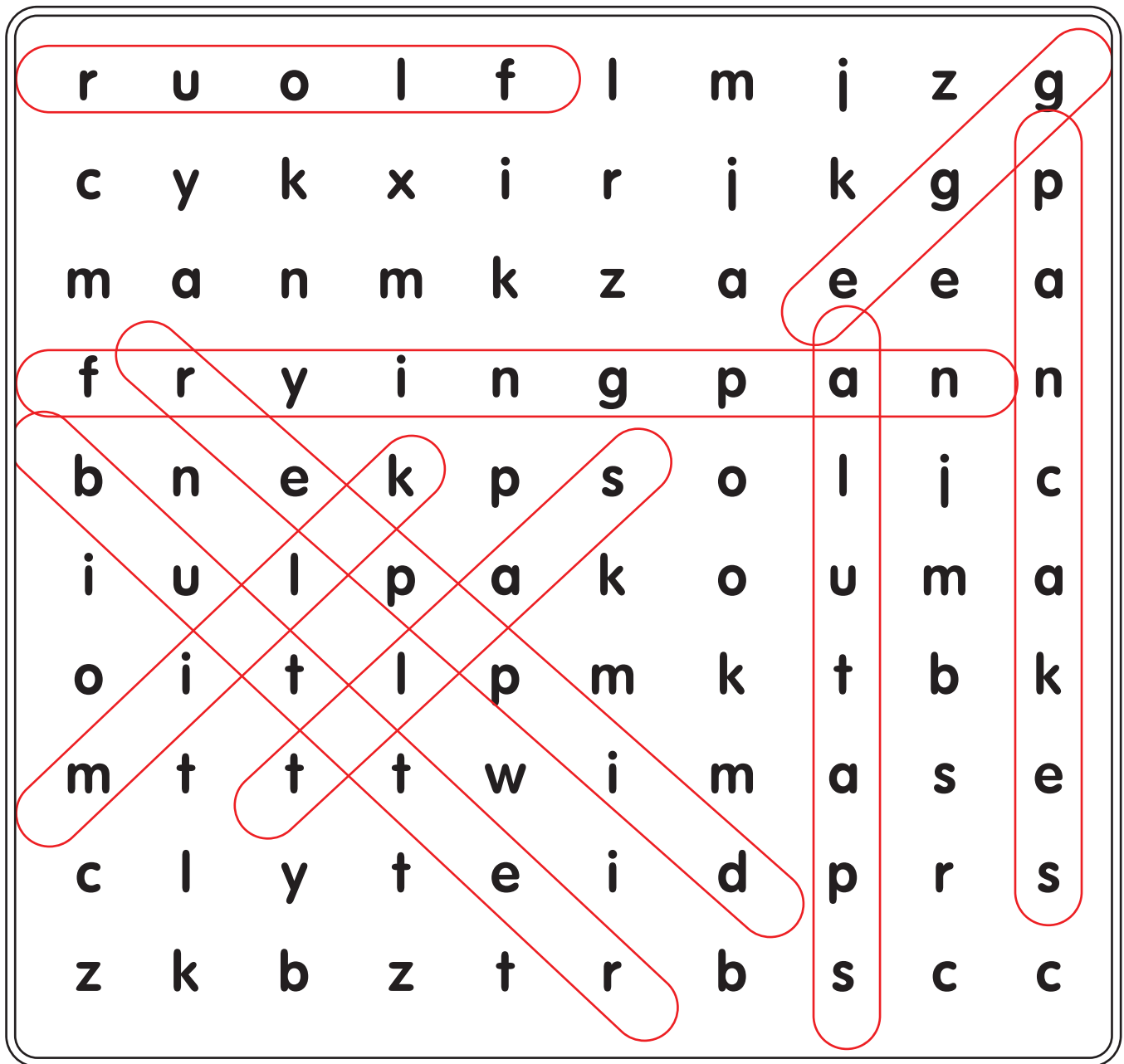

Egg

Milk

Flour

Frying pan

Pancakes

Dipper

Butter

Salt

Spatula

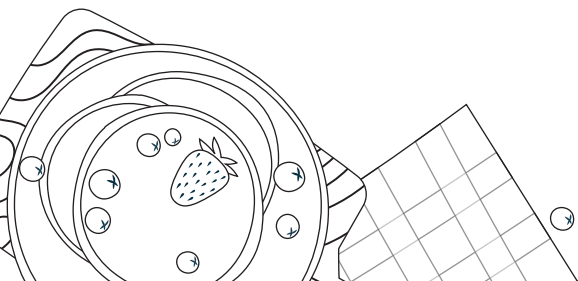

# Pancake toppings

Write a description of each topping

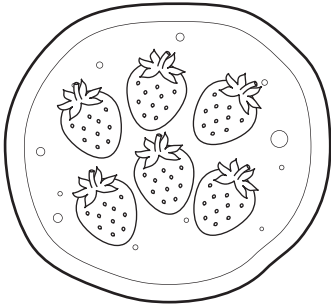

There are five strawberries

on top of the pancake.

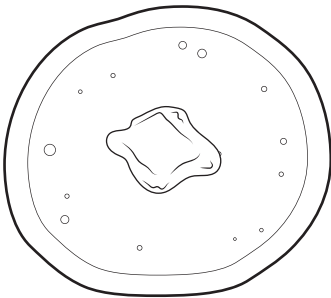

There is melting butter

on top of the pancake.

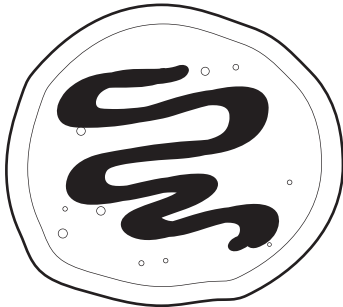

There is chocolate sauce

on top of the pancake.

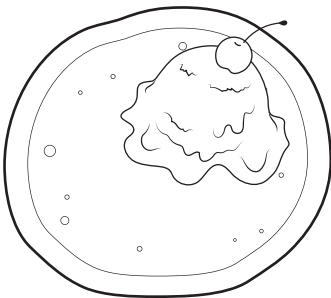

There are a scoop of ice cream

and a cherry on top of the pancake.

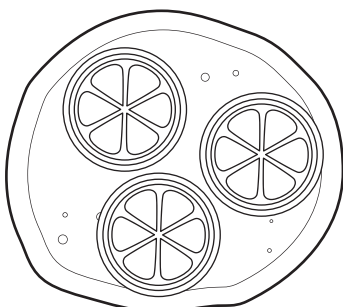

There are three oranges

on top of the pancake.