

ทากาว

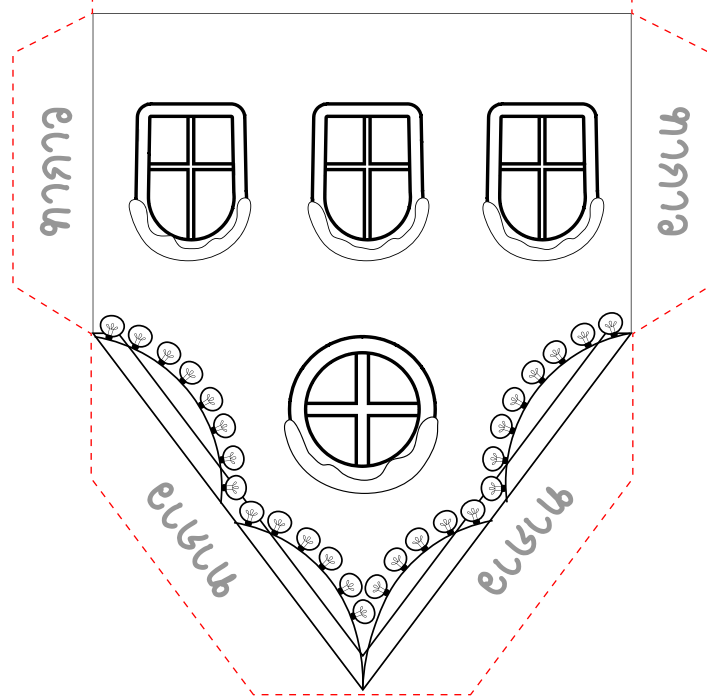

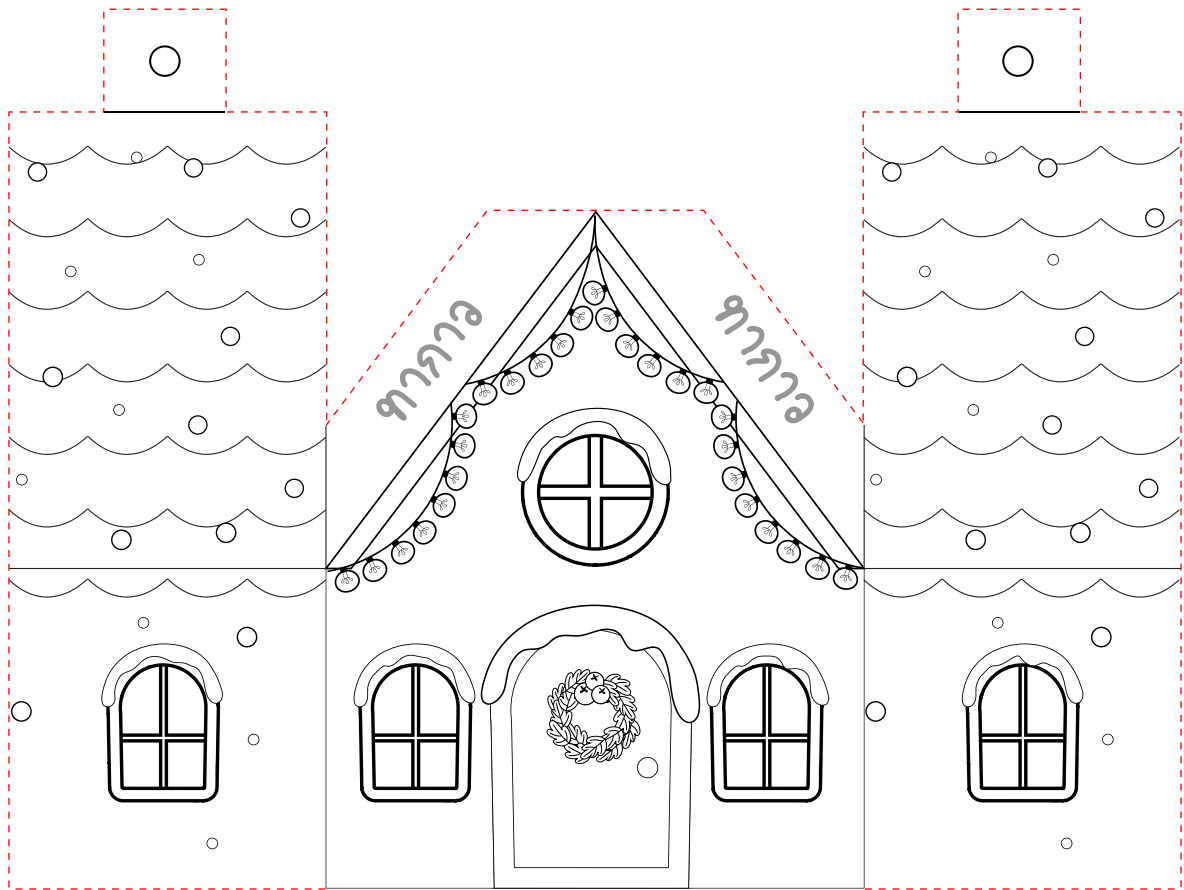

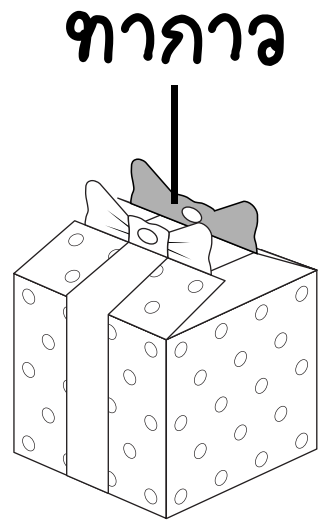
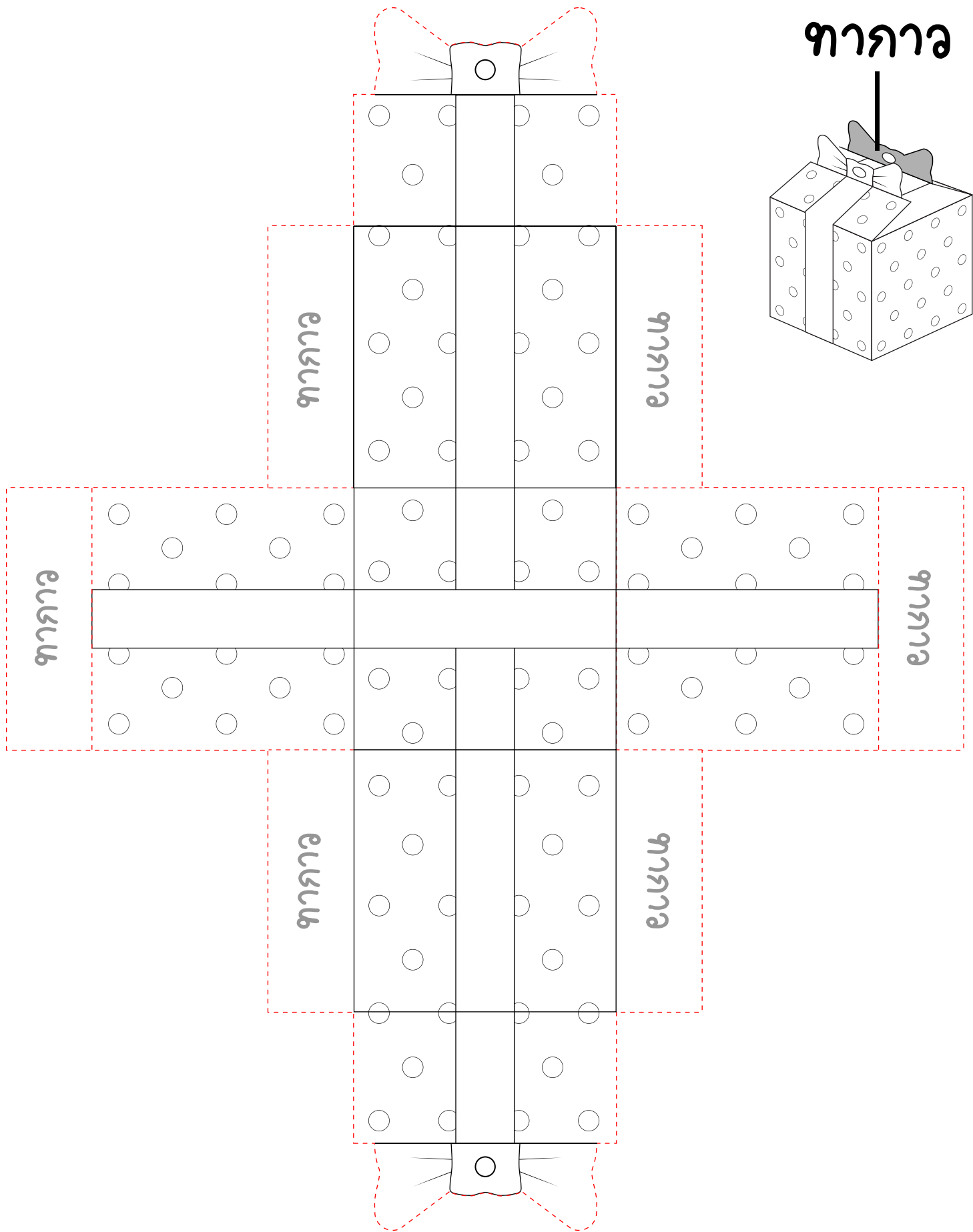
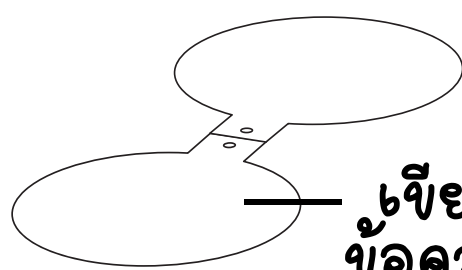
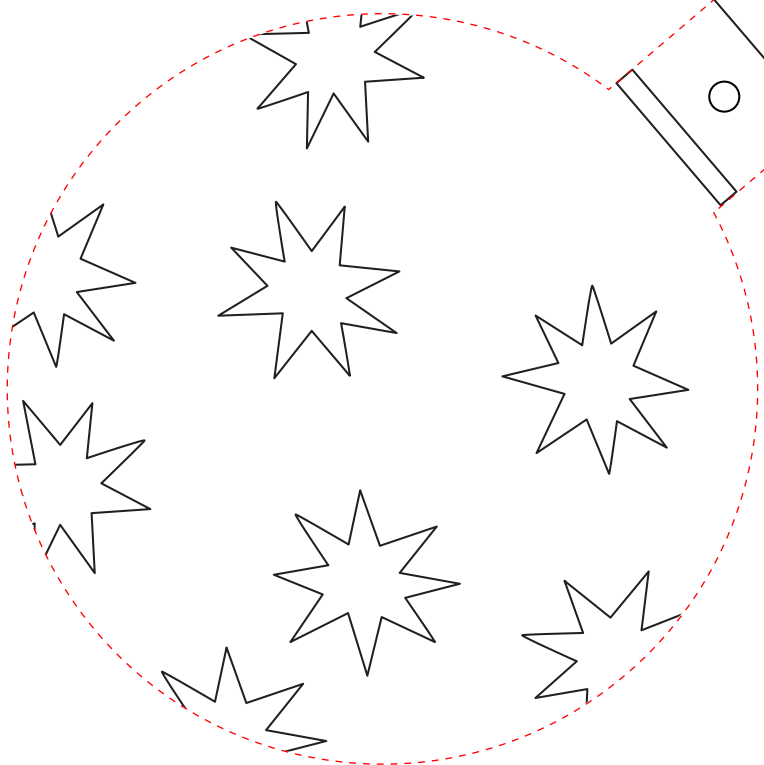
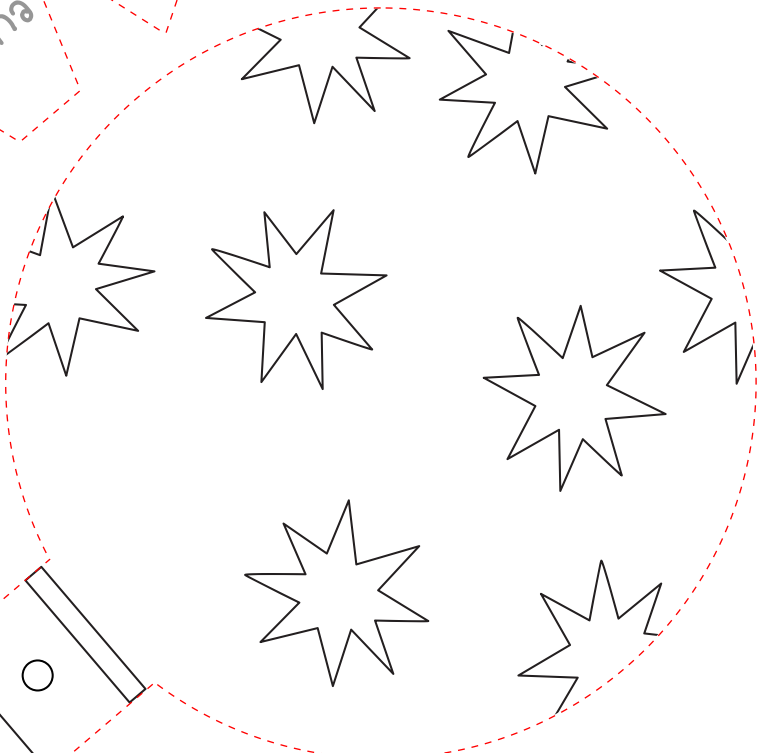
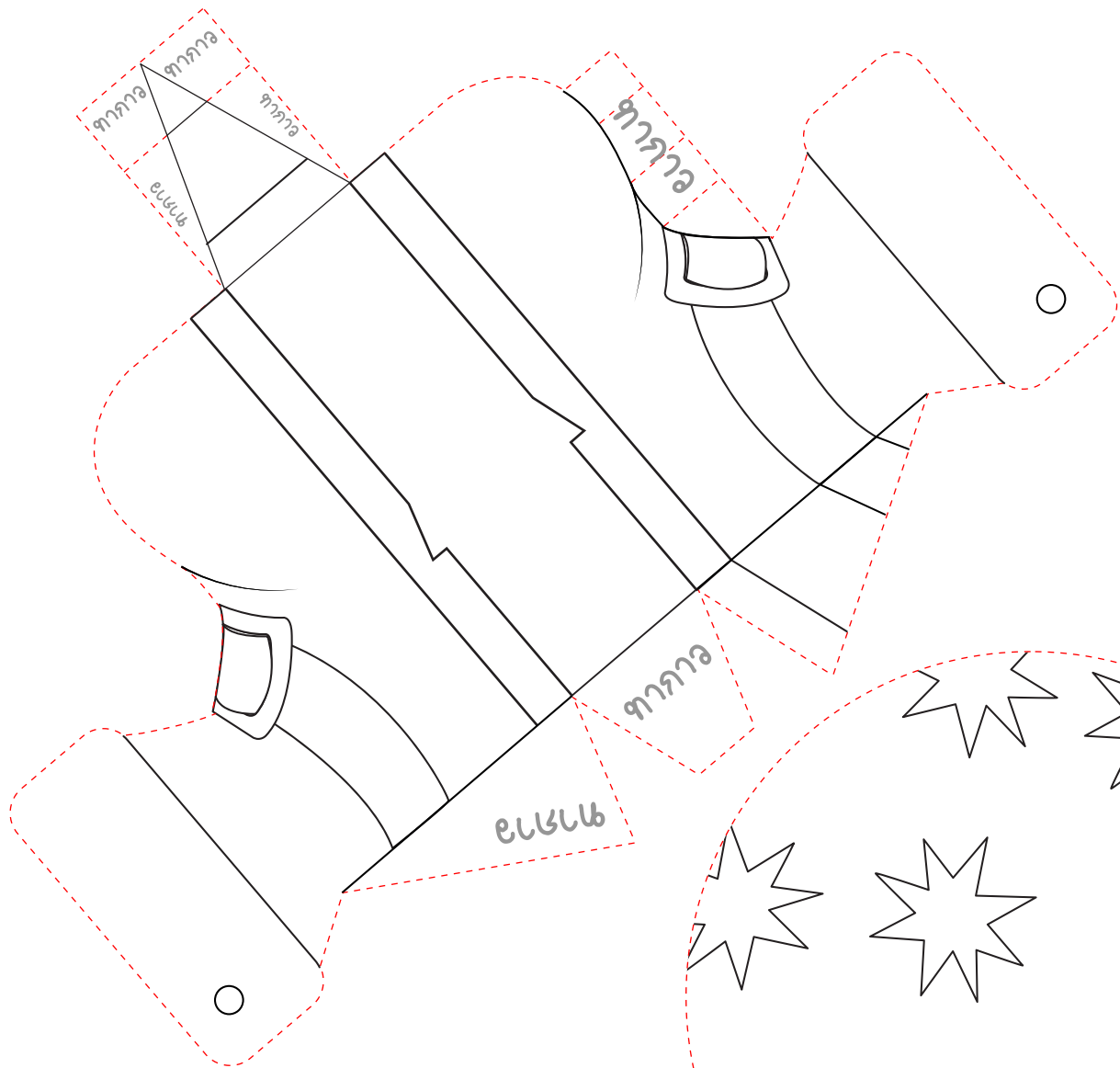

เขียน
ข้อความ

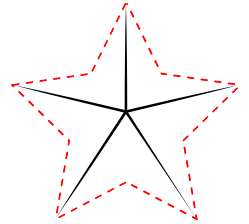
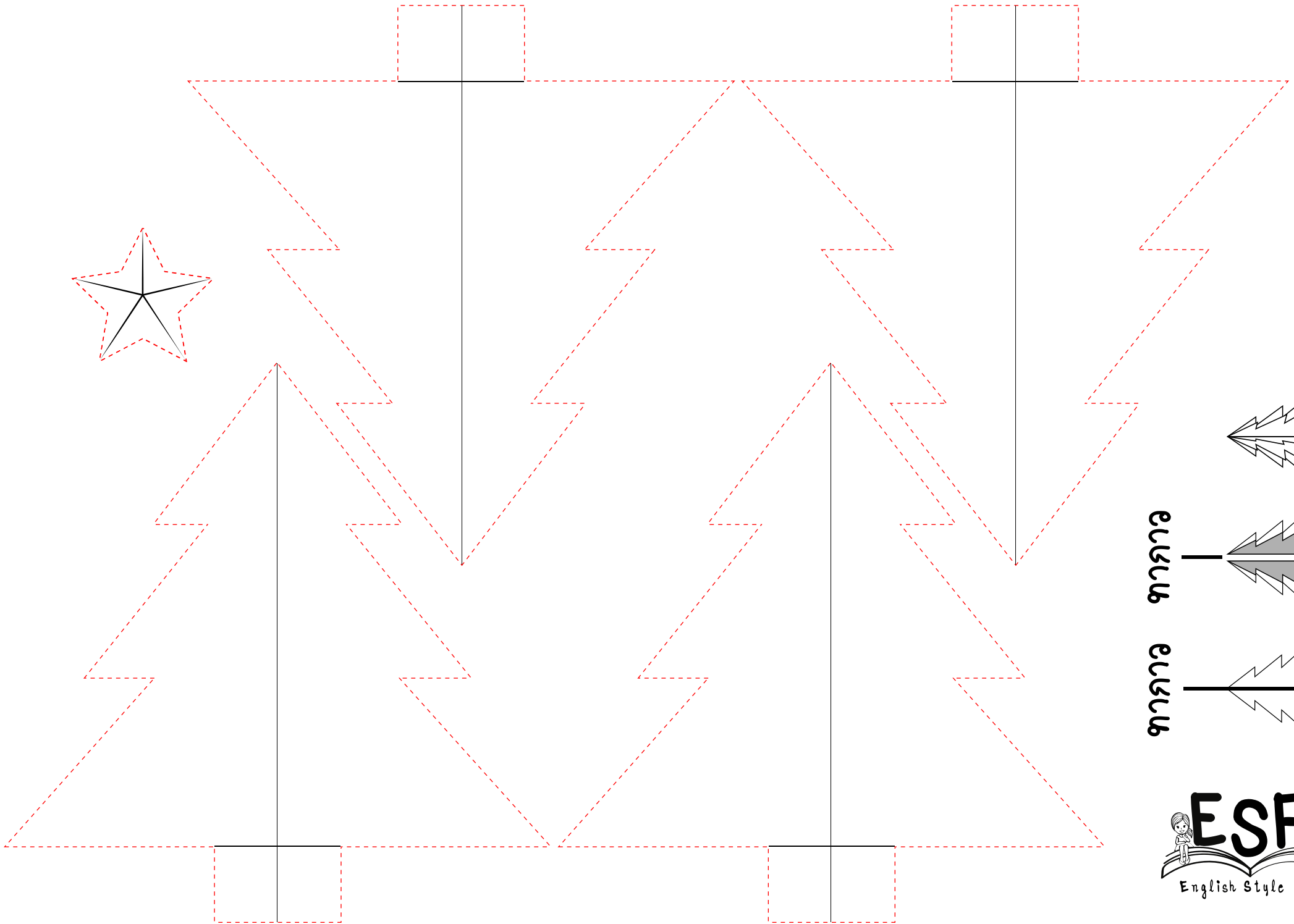

การากาว

การากาว

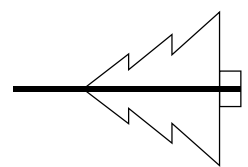
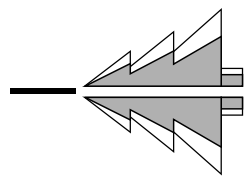
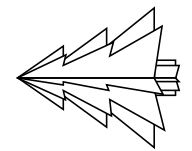

Merry!
Christmas

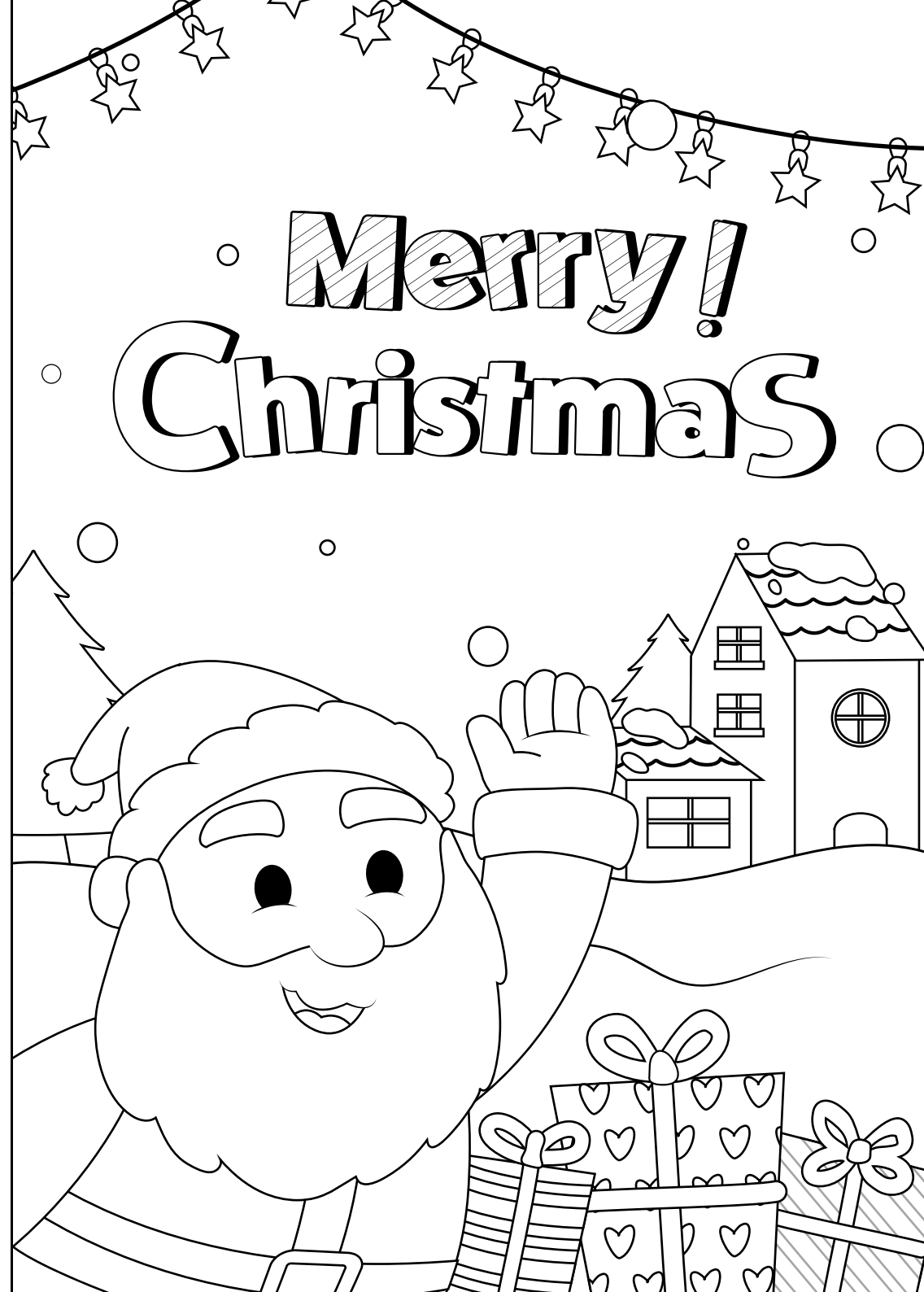

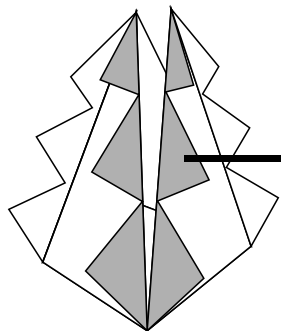
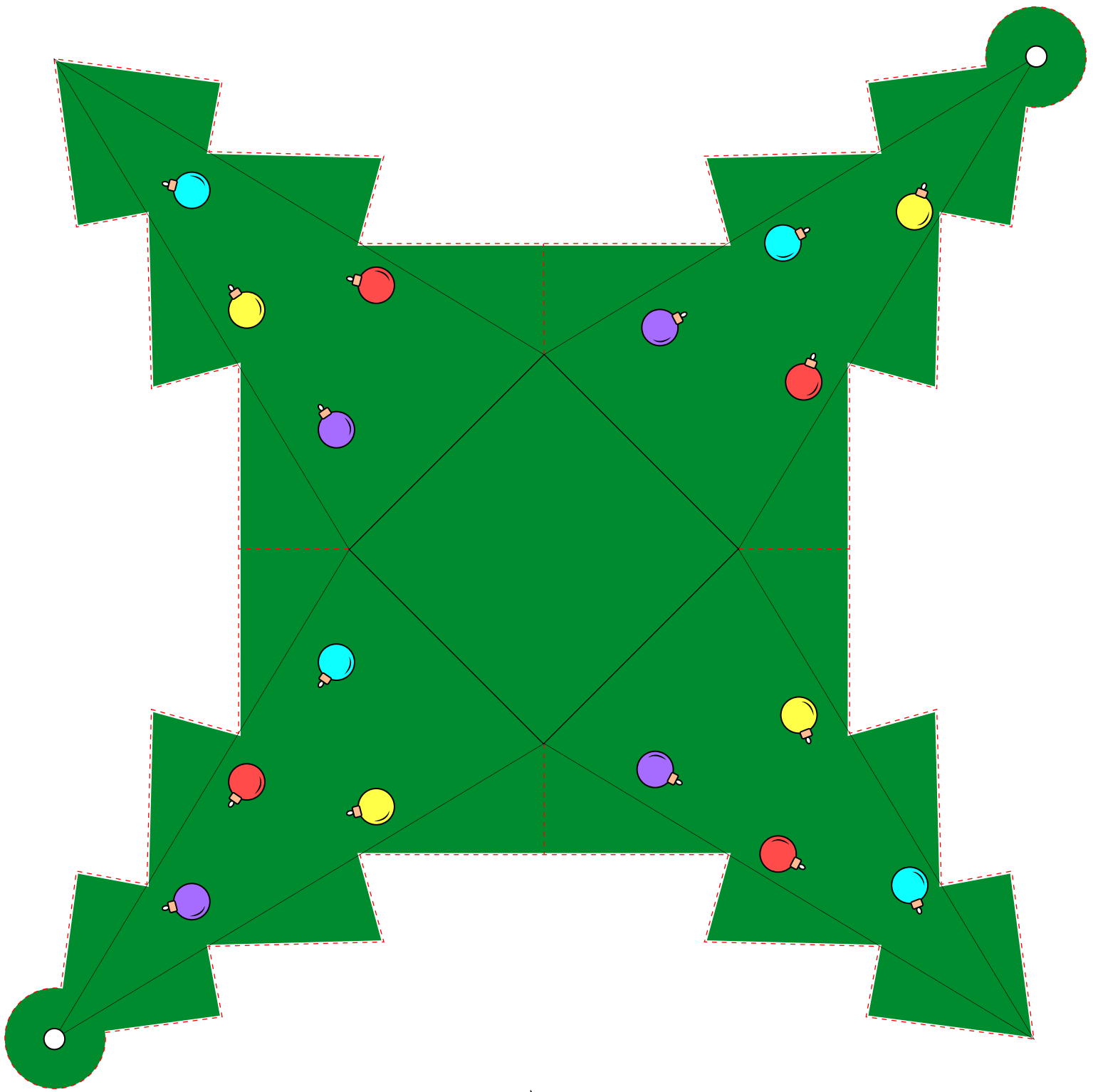

ຫາກາວ



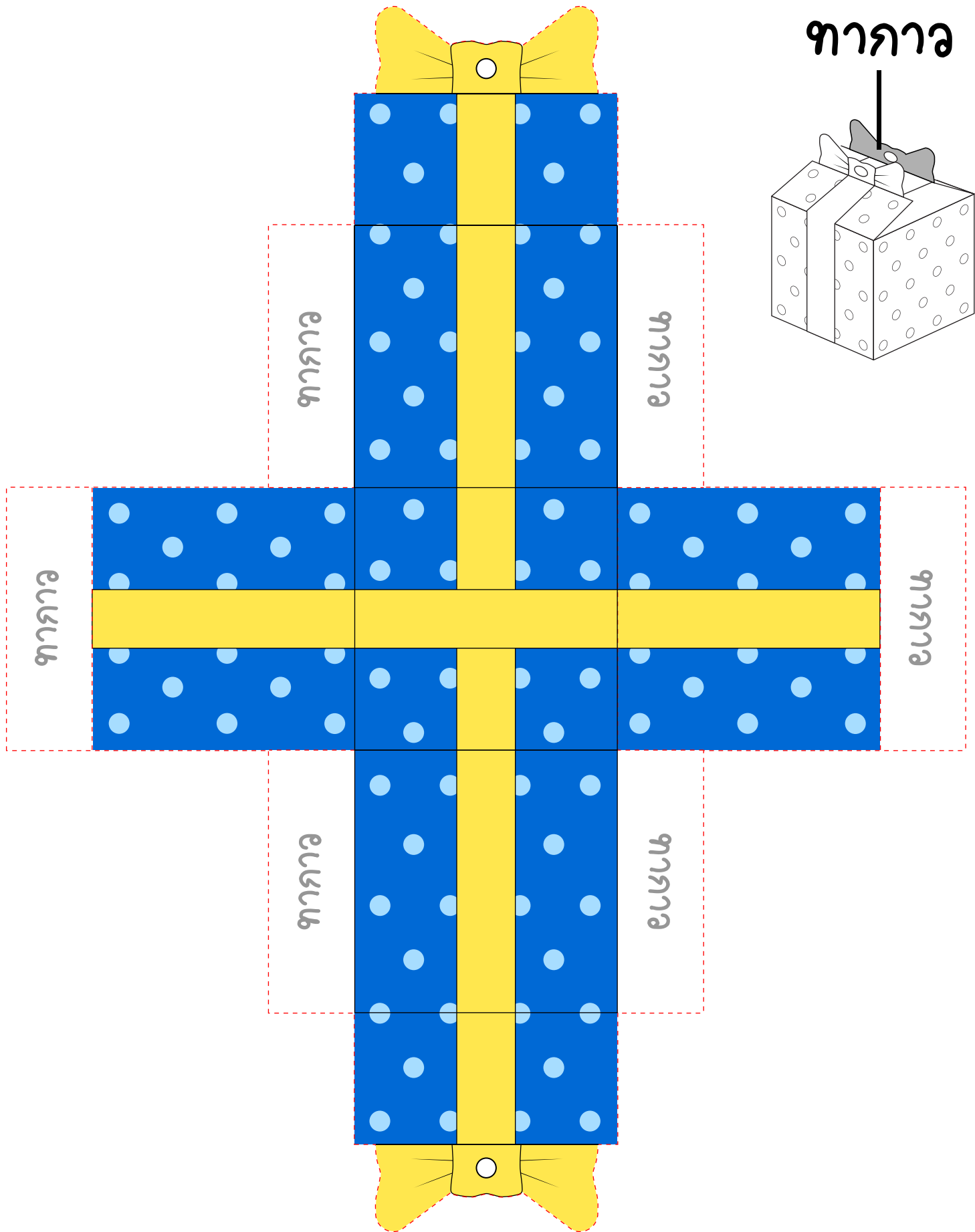

กาгаอ

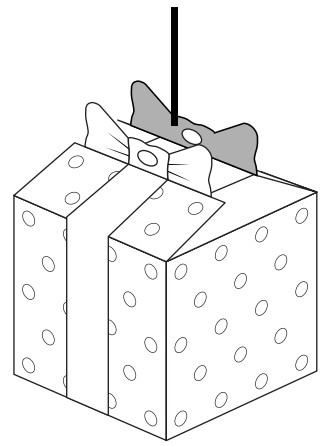

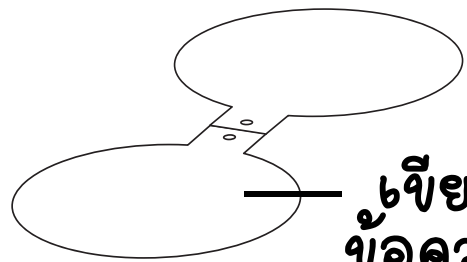
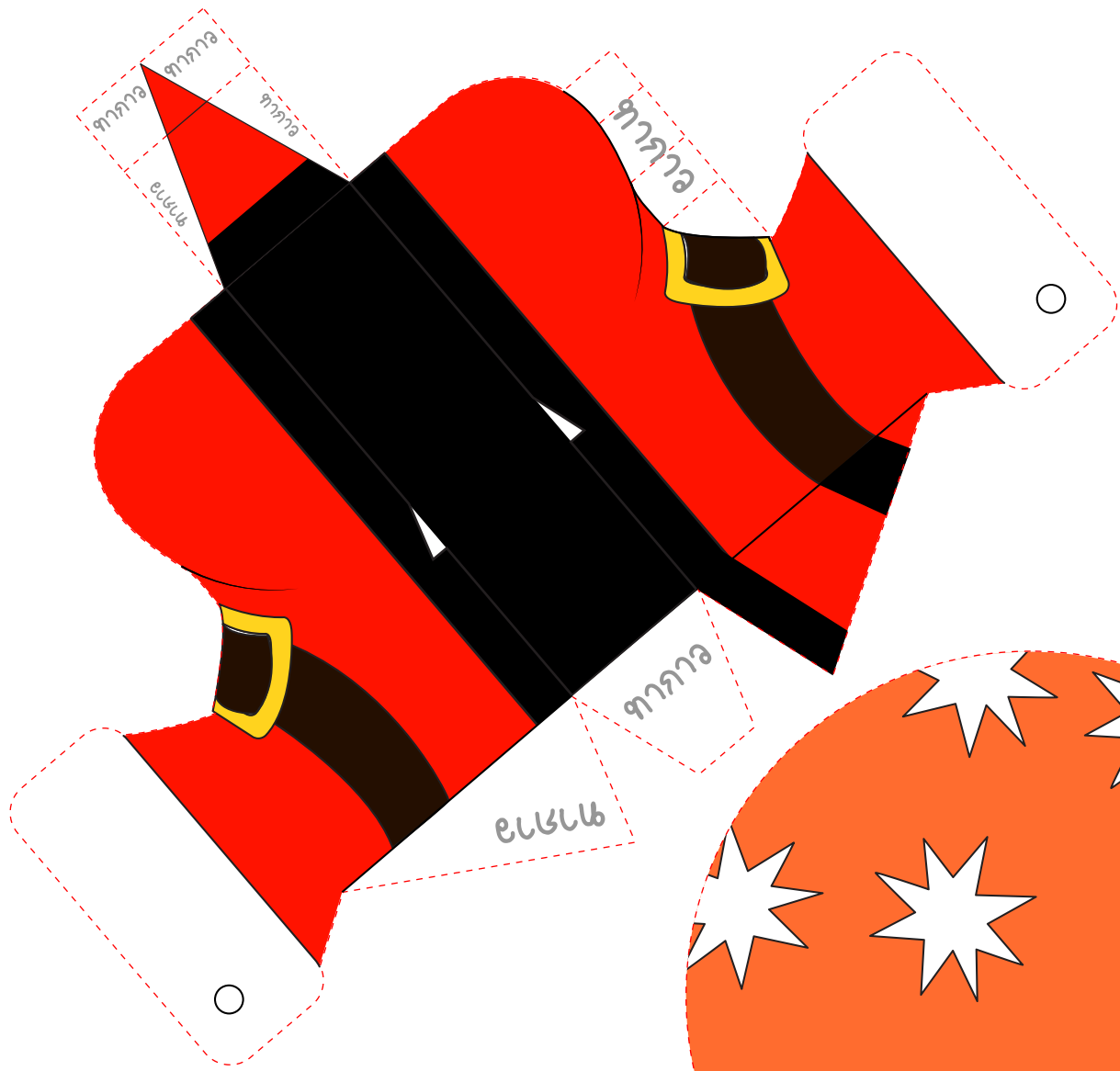

เขียน
ข้อความ

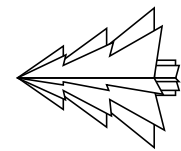
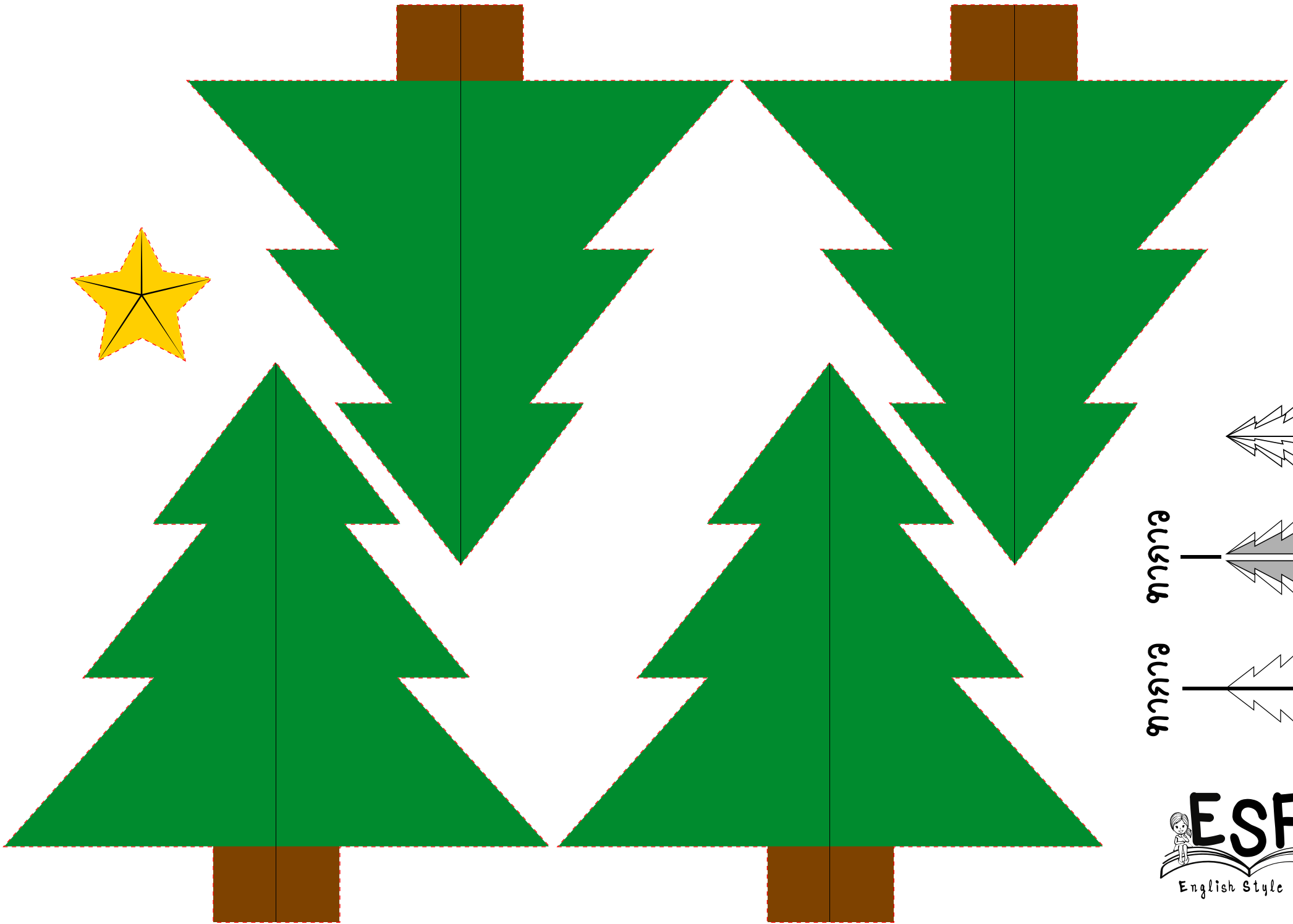

การ

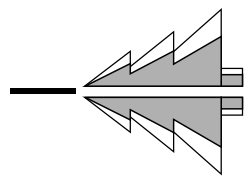

การ

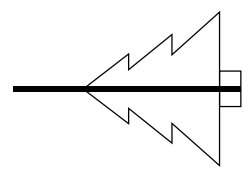

Merry!
Christmas

