

ทากาว

ทากาว

ทากาว

⊗ _____ ❀ _____ ⊗

When built 10 August 1793

One unique fact The largest museum in the world.

Why was it built Before it was a museum, the Louvre was a palace and the seat of the French monarchy.

⊗ _____ ❀ _____ ⊗

ทากาว

ทากาว

ทากาว

ทากาว

ทากาว

ทากาว

ทากาว

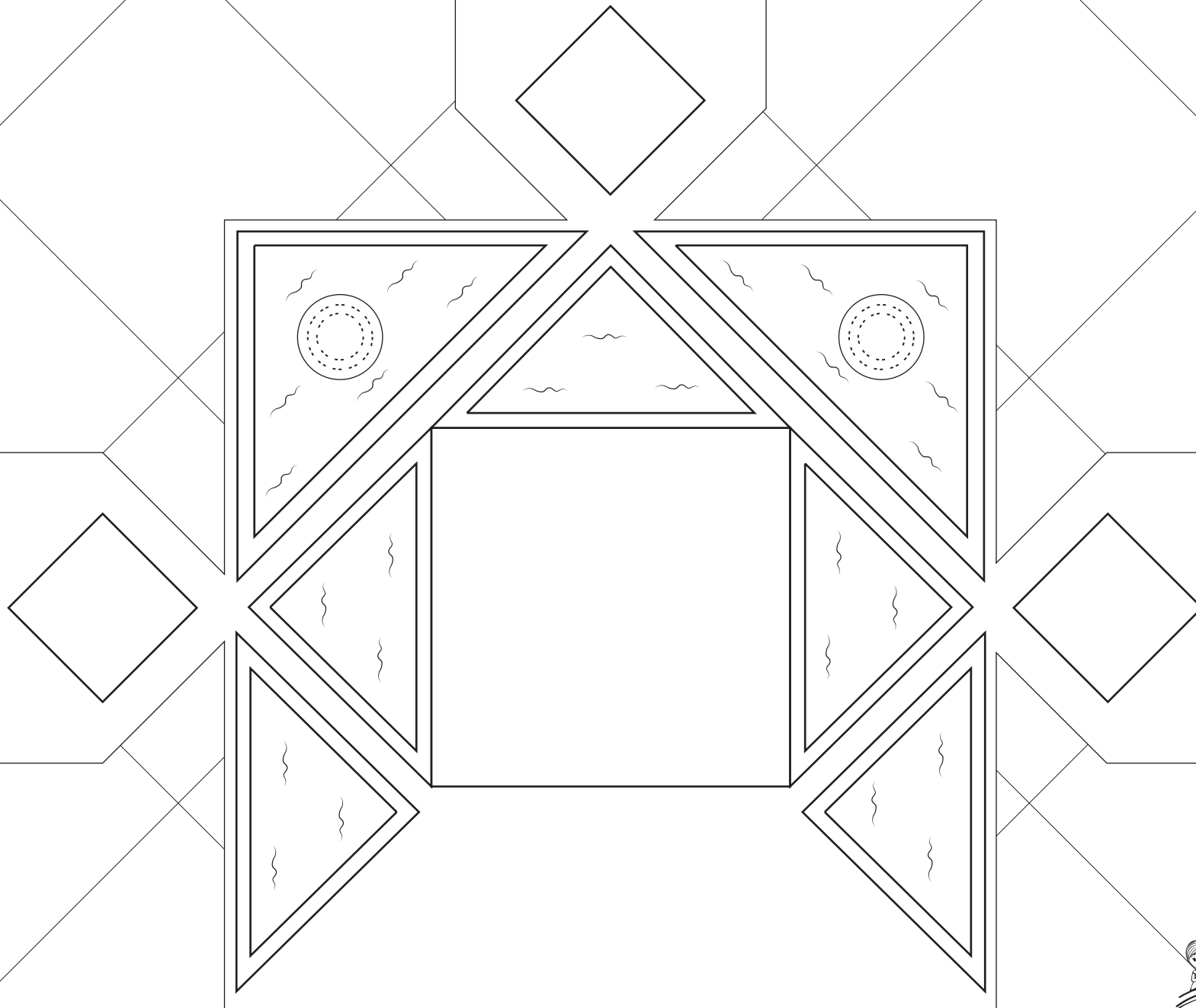

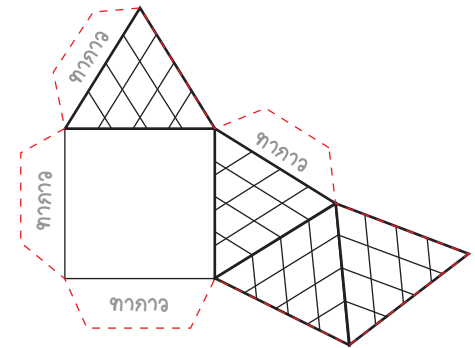
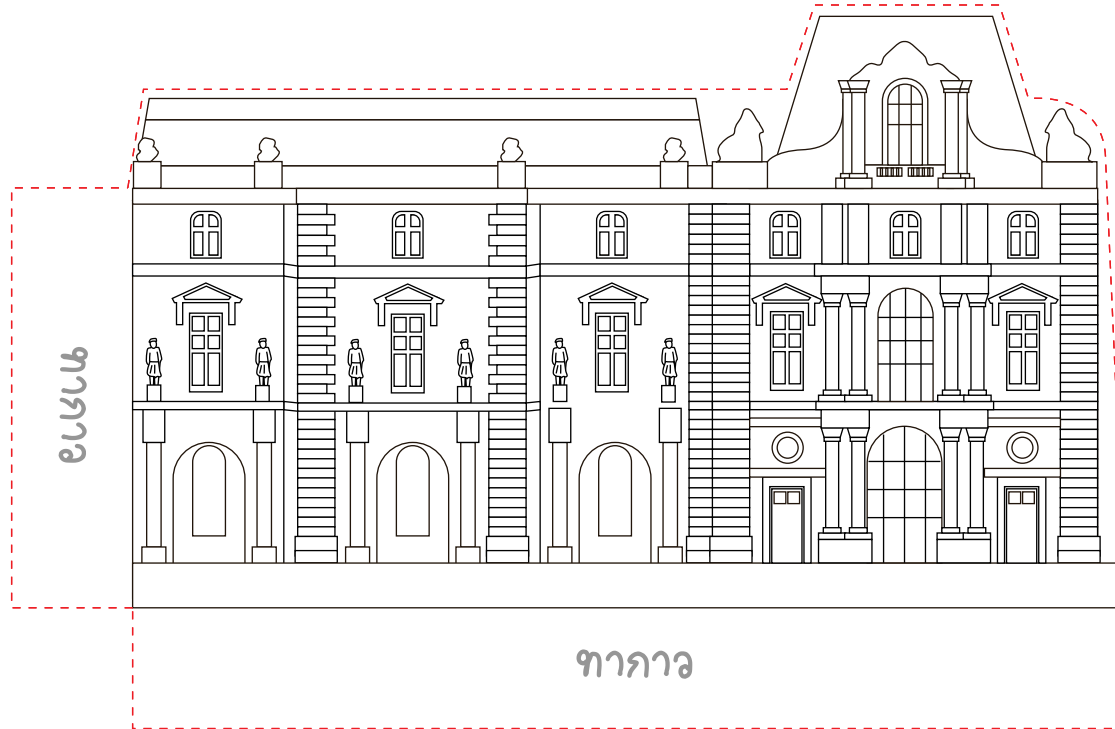
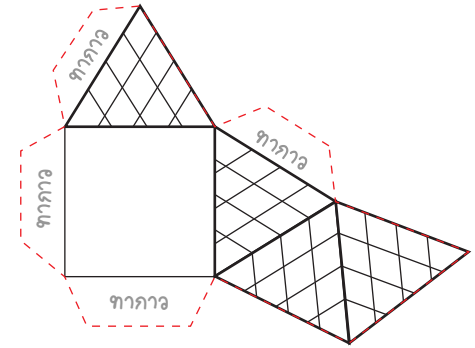
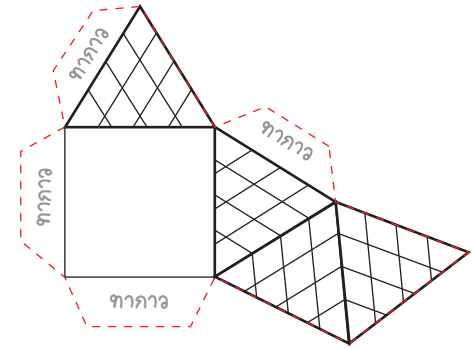
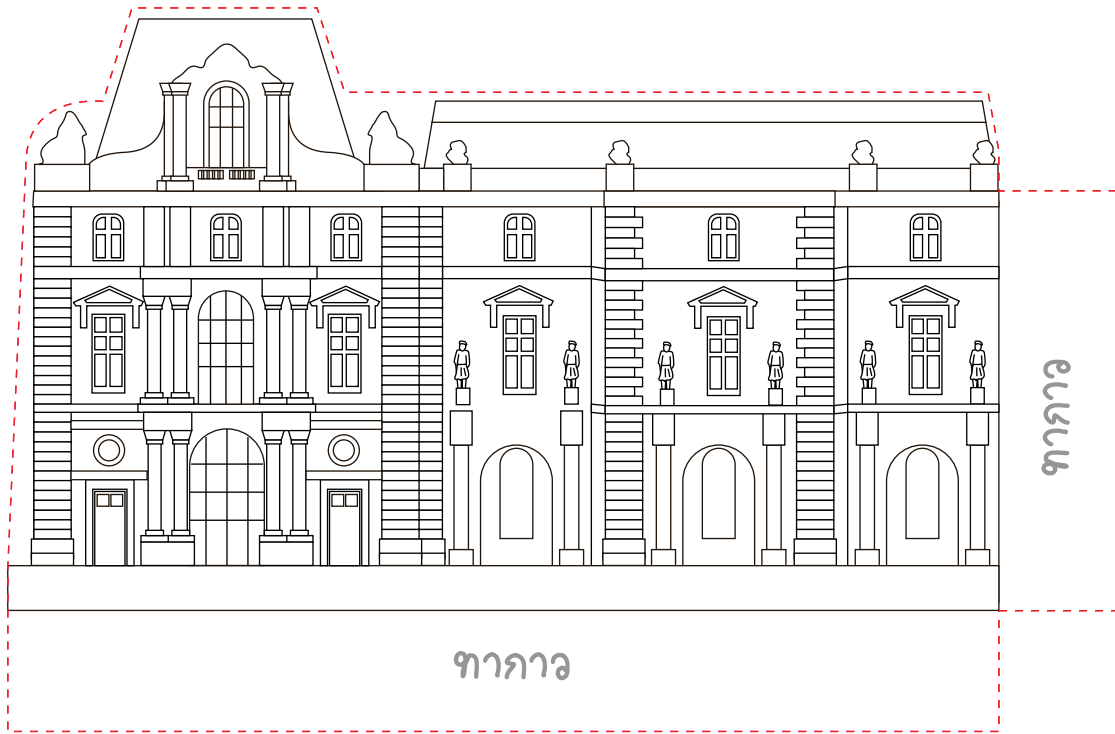

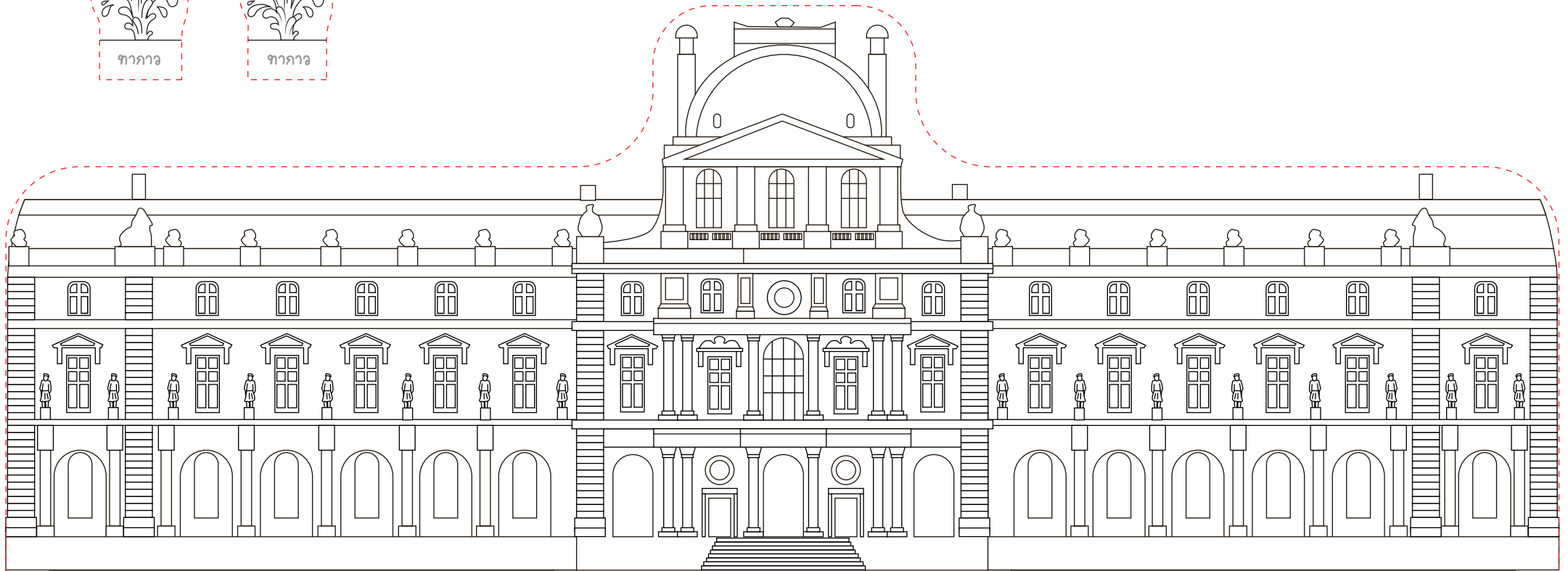
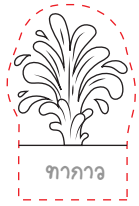
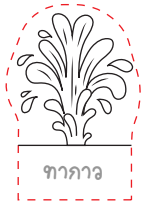

ทิวแถว

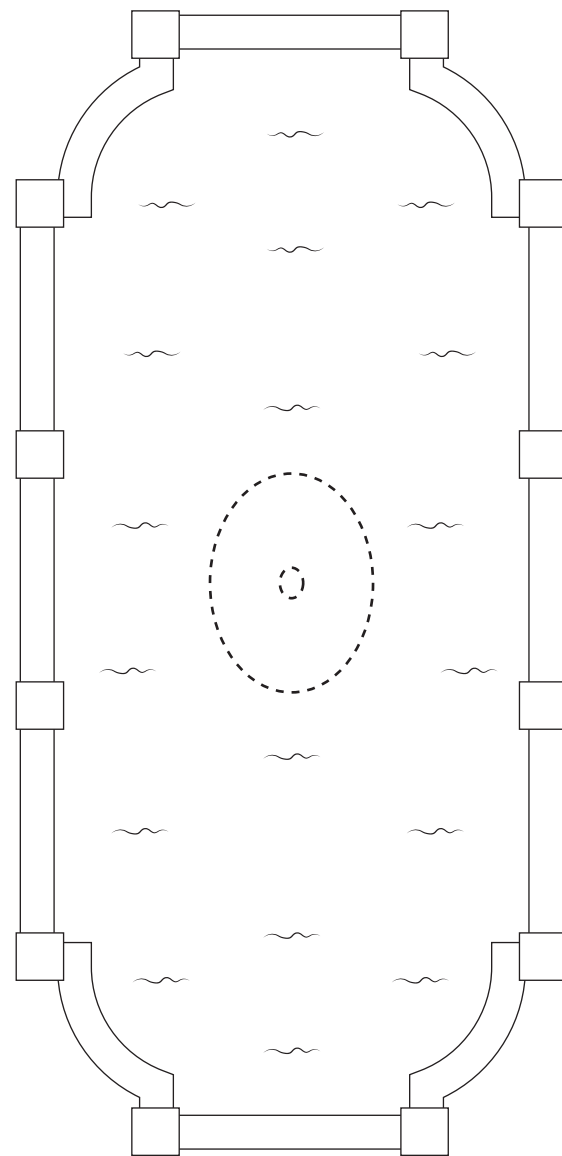
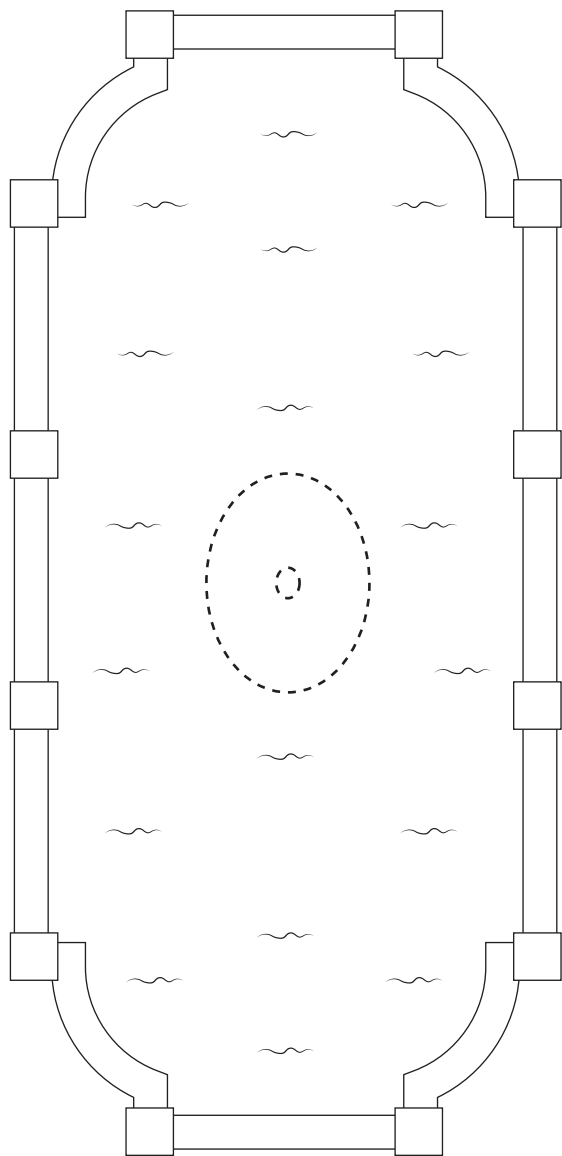

ຫາກາວ

ຫາກາວ

ຫາກາວ

ຫາກາວ

ຫາກາວ

ຫາກາວ

ຫາກາວ

ຫາກາວ

ຫາກາວ

ຫາກາວ

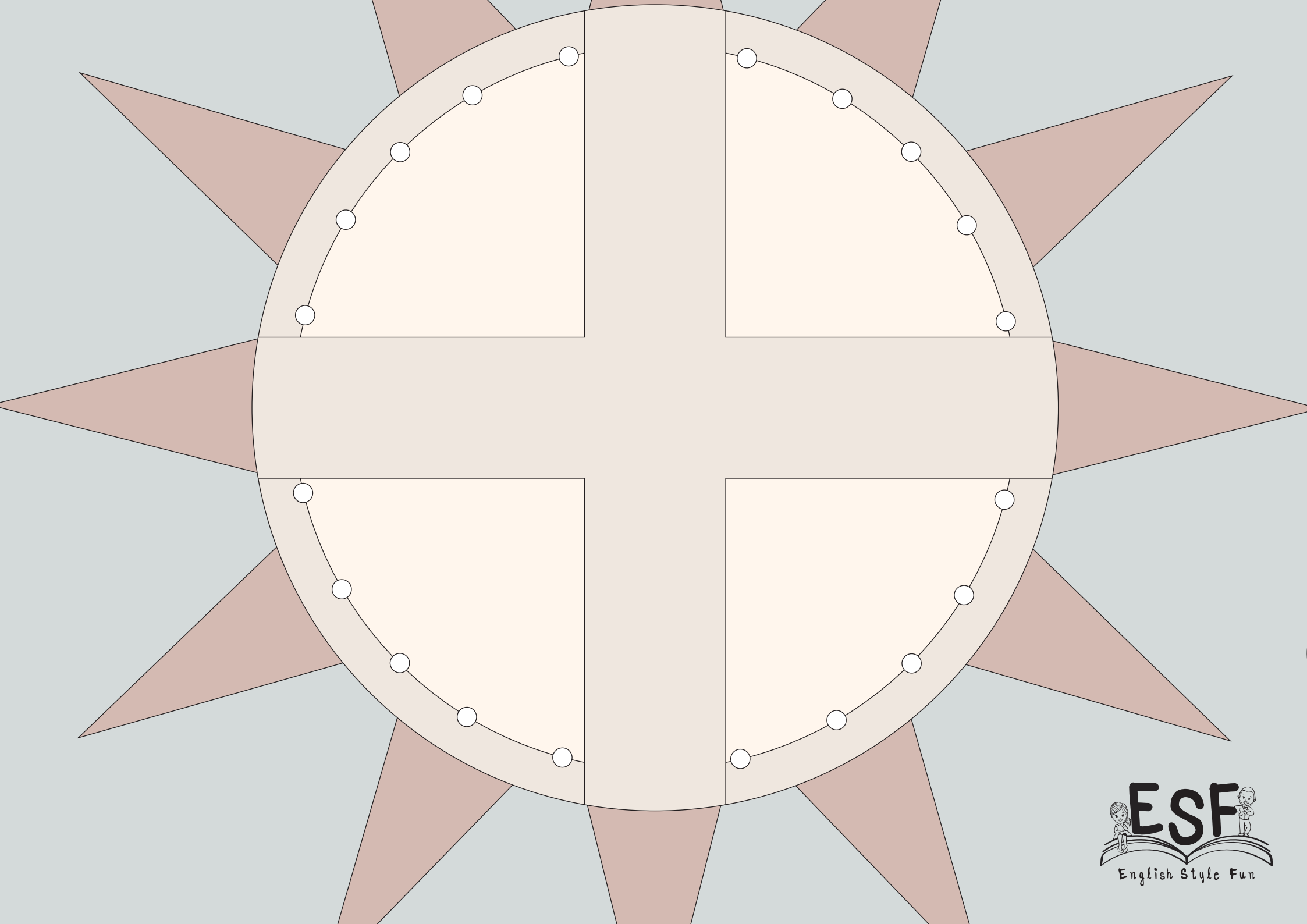

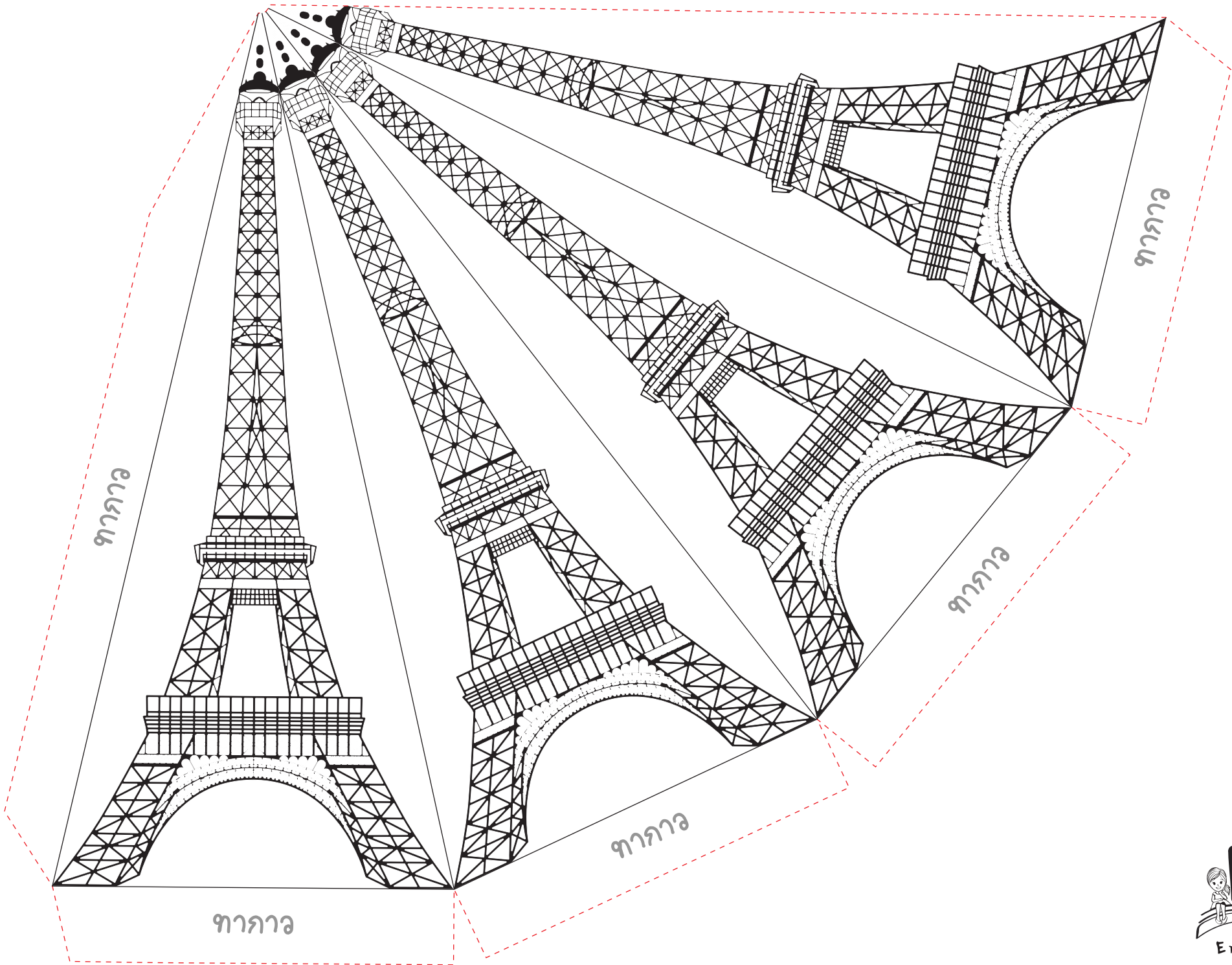

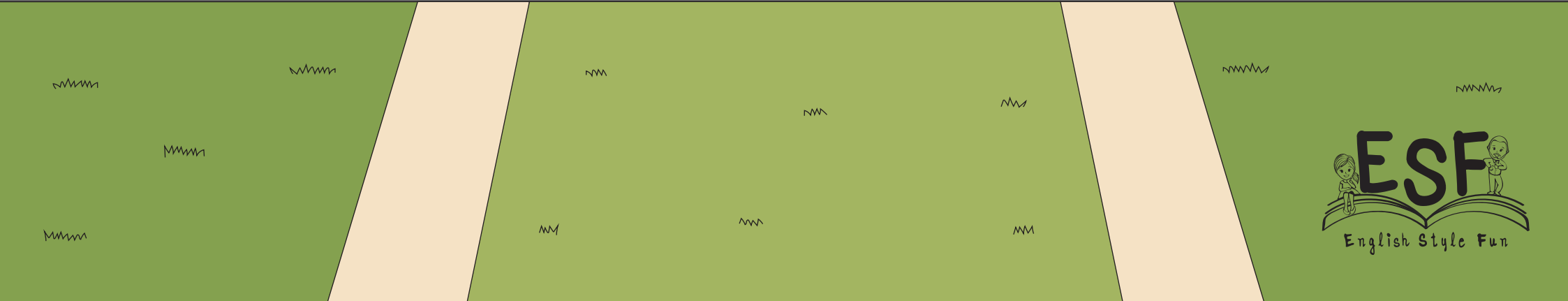
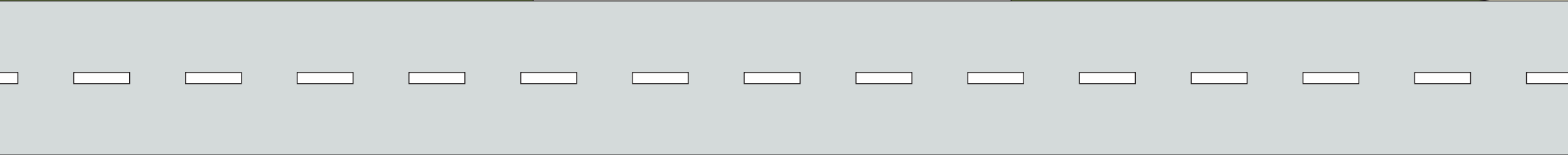
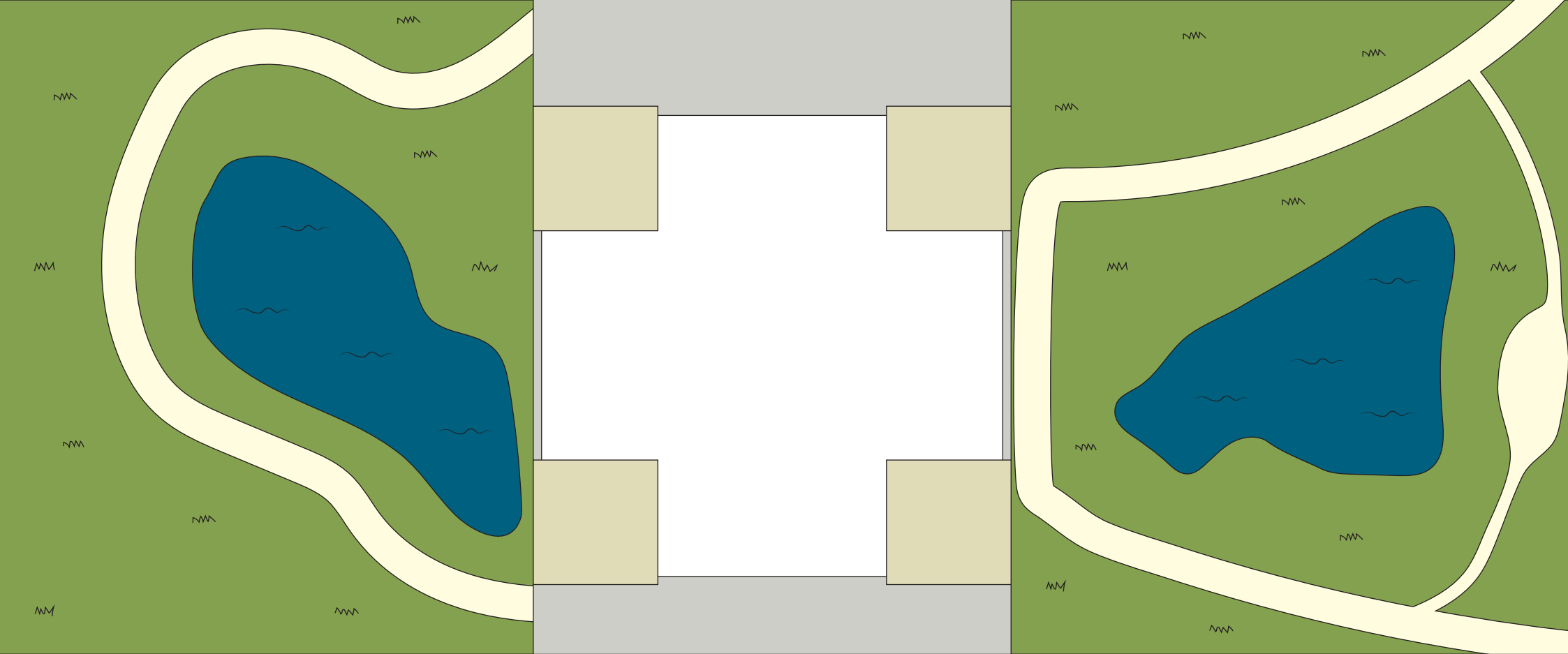

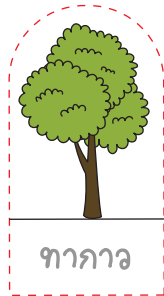
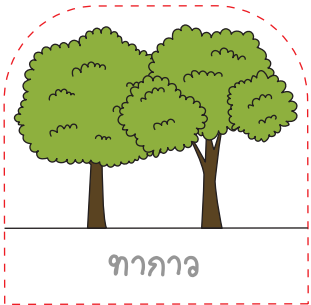
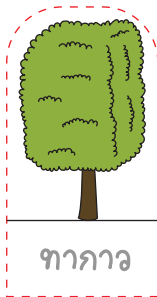
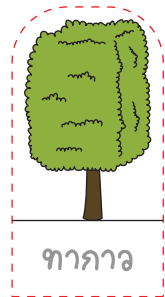
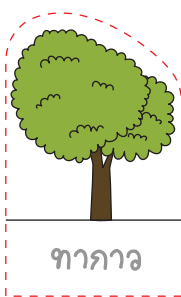
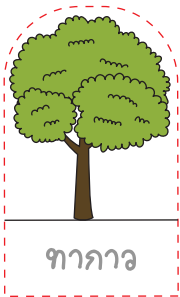
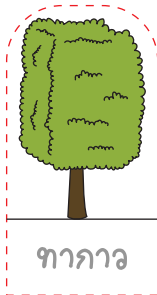
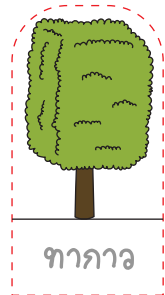
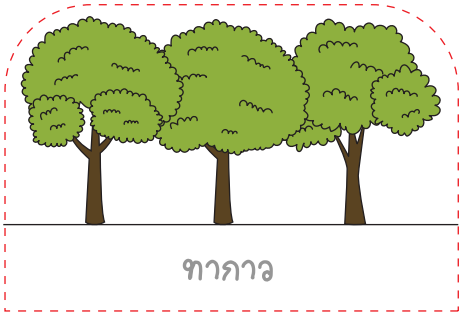

தாகავ

தாகავ

தாகავ

⊗

⊗

When built 1887

One unique fact
For four decades it was the world's tallest structure.

Why was it built
The Eiffel Tower was built to be one the main attractions at the Paris World's Fair in 1889.

⊗

⊗

தாகავ

தாகავ

தாகავ

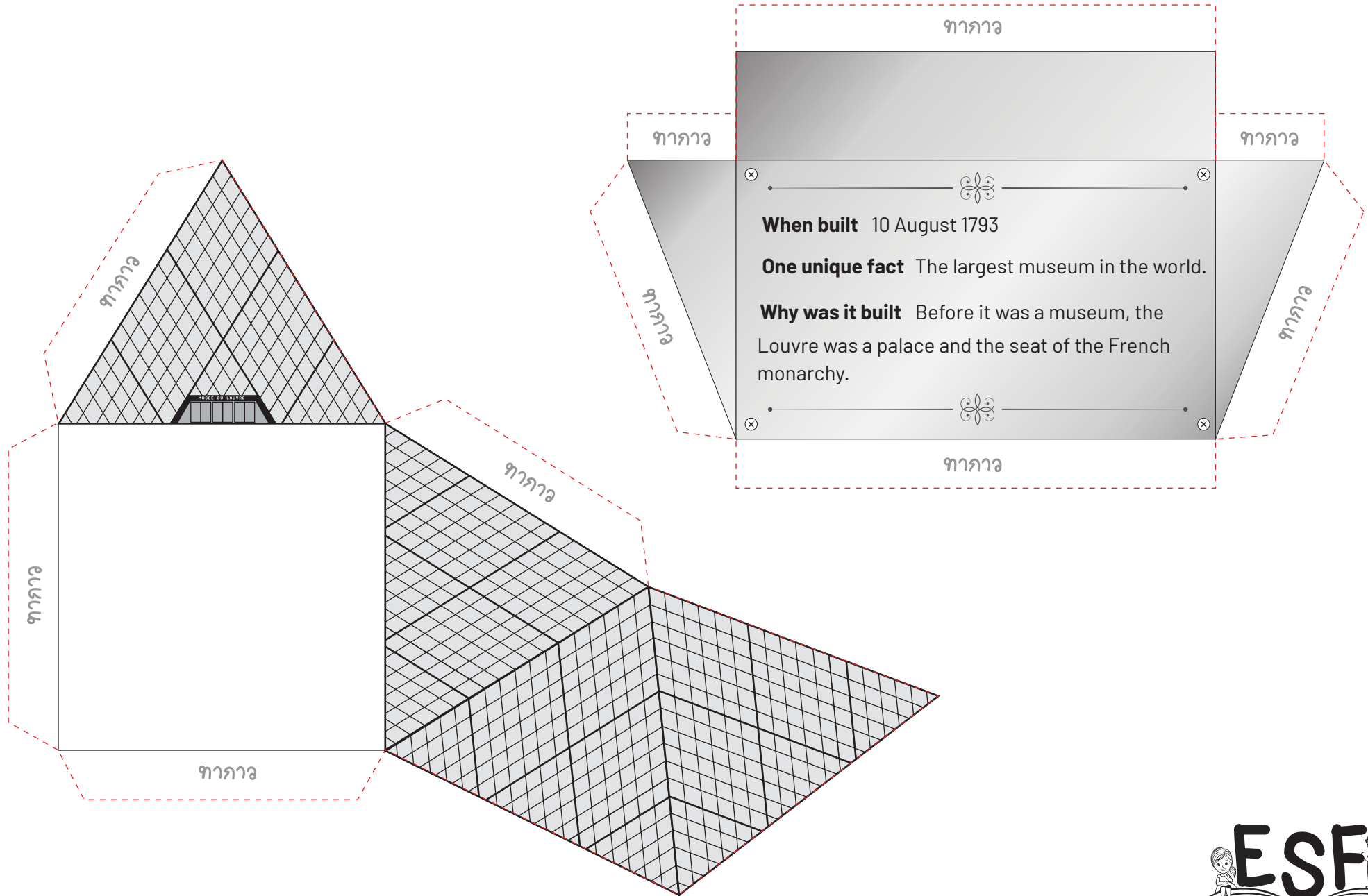

ทากาว

ทากาว

ทากาว

ทากาว

ทากาว

ทากาว

ทากาว

ทากาว

ทากาว

ทากาว

• ————— ❁ ————— •

When built 10 August 1793

One unique fact The largest museum in the world.

Why was it built Before it was a museum, the Louvre was a palace and the seat of the French monarchy.

• ————— ❁ ————— •

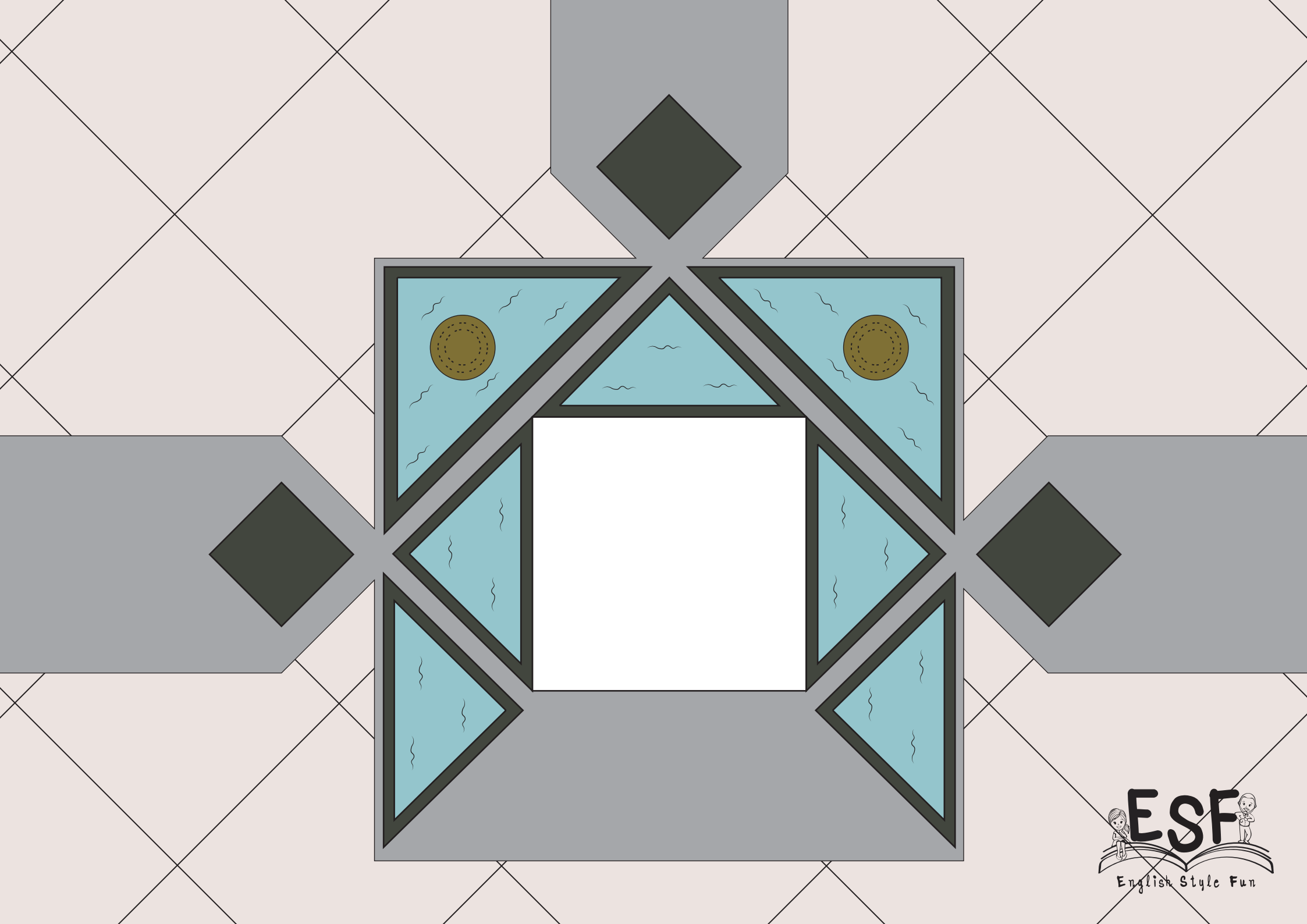

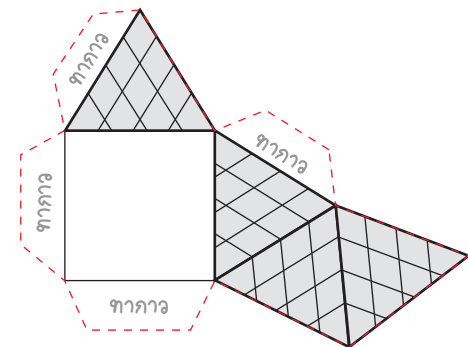
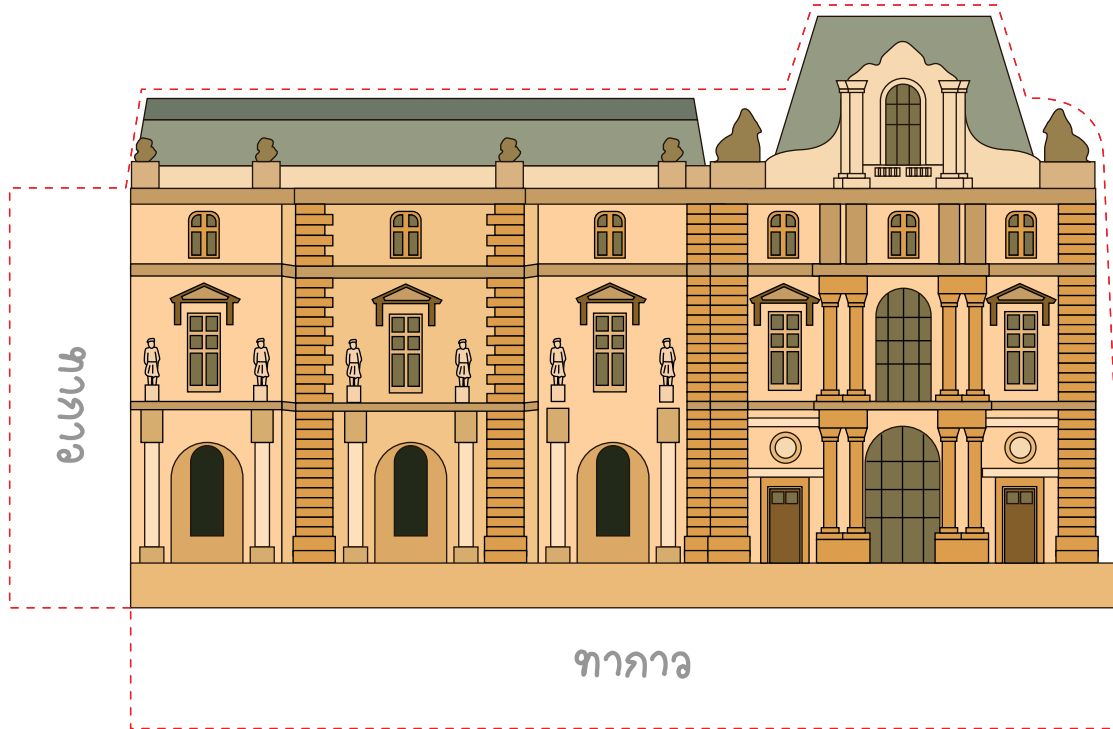
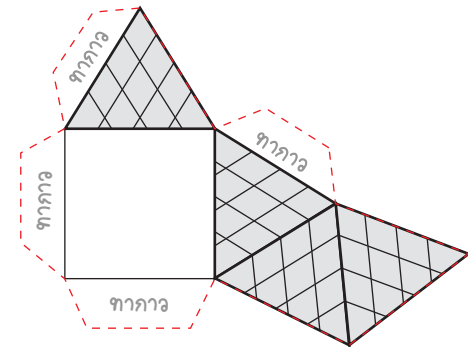
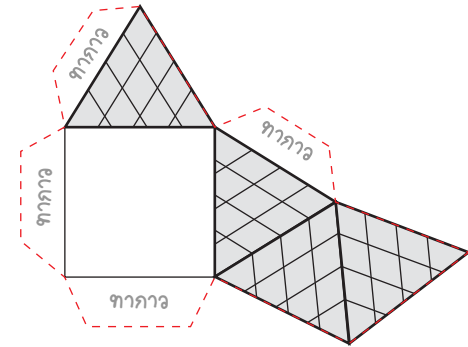
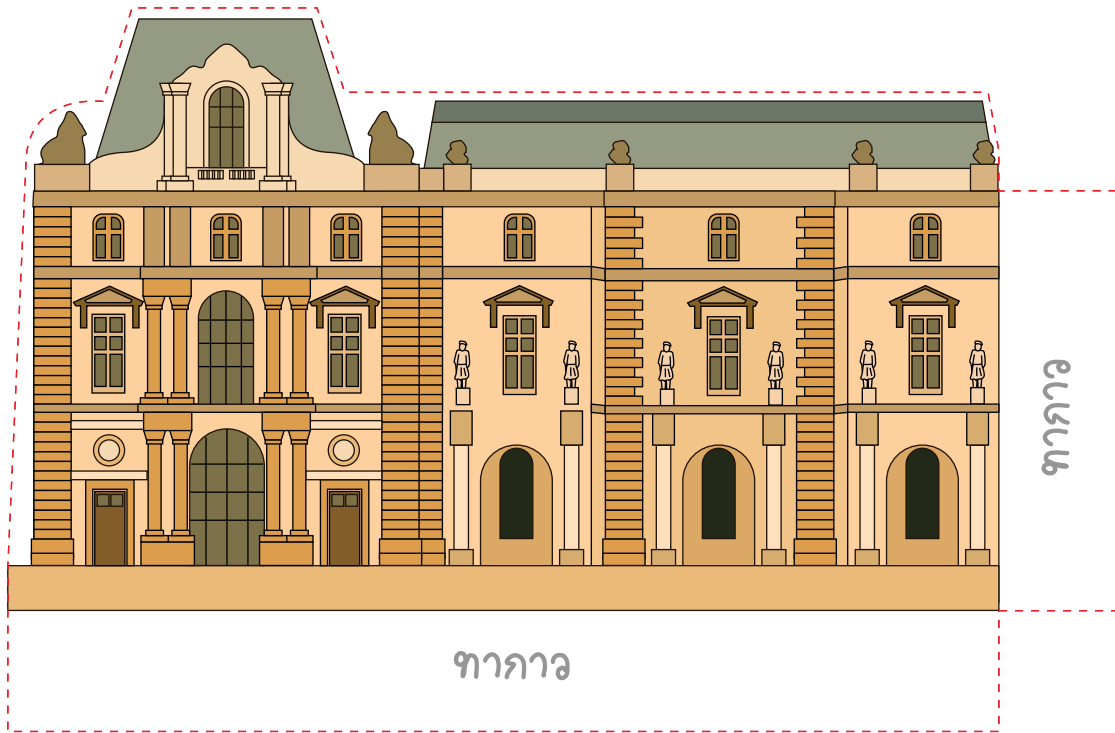

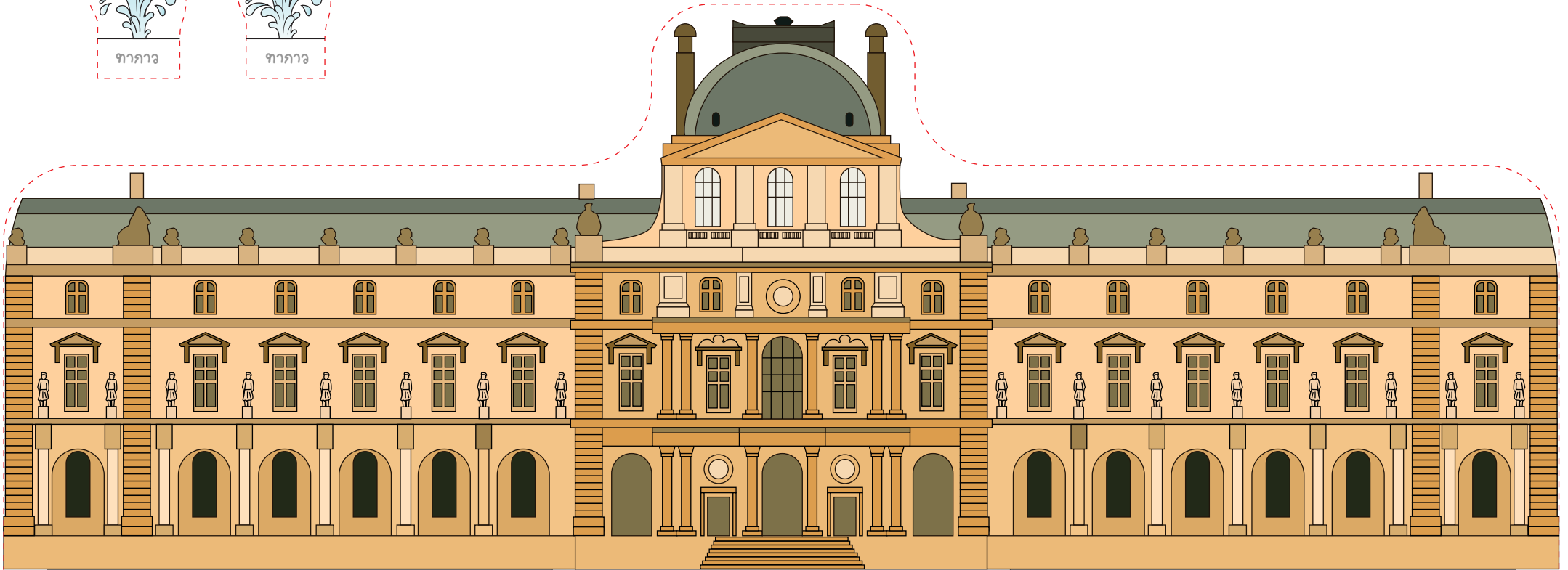
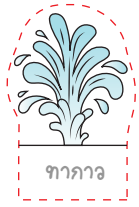
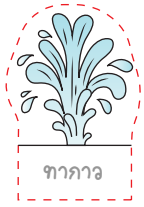

ทิวแถว

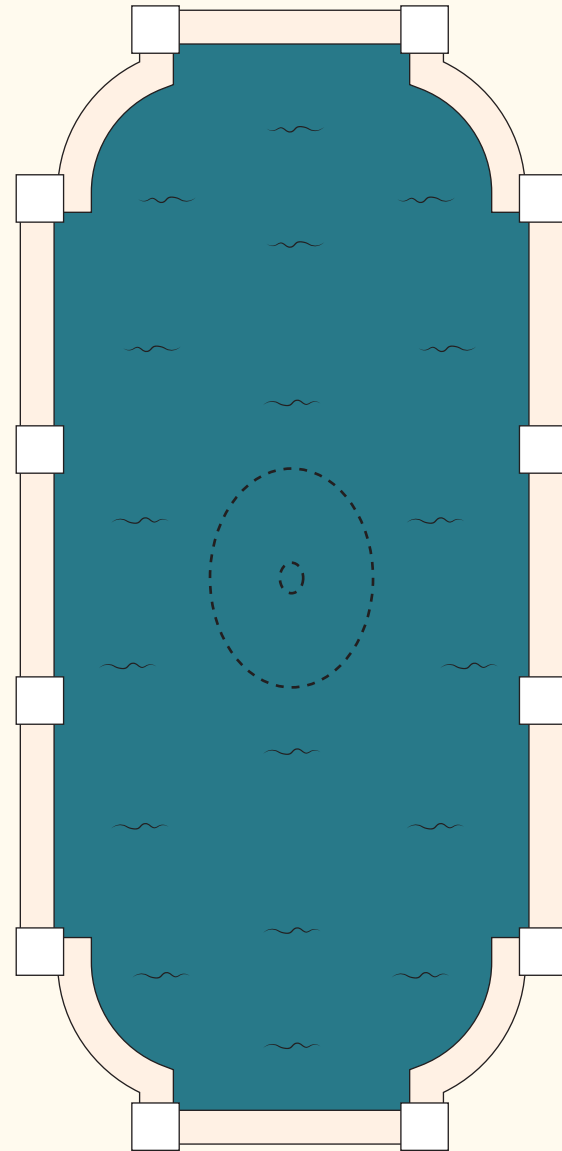
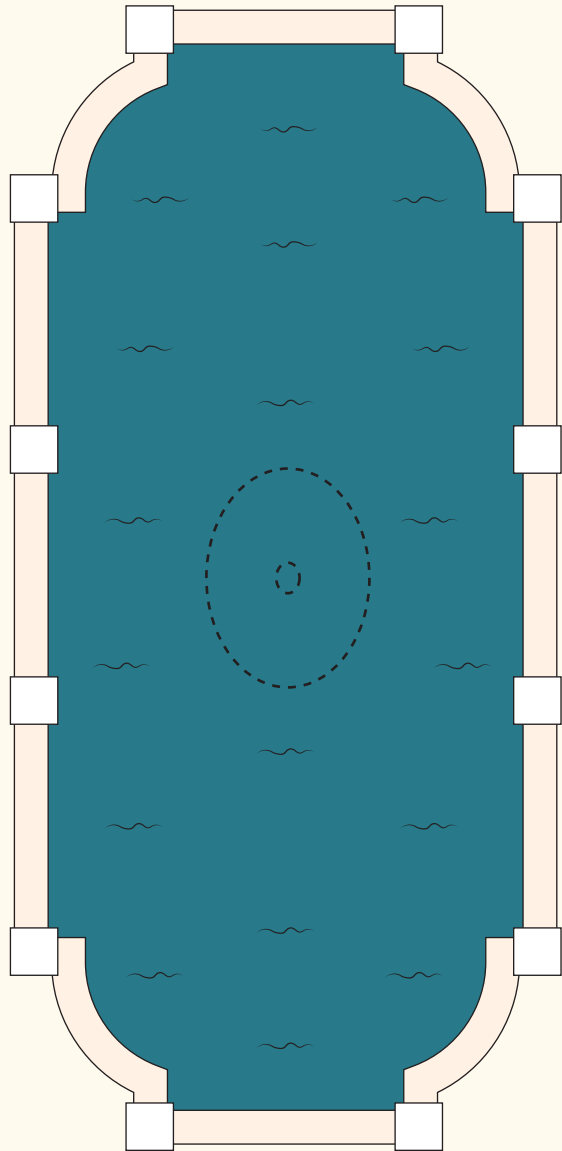

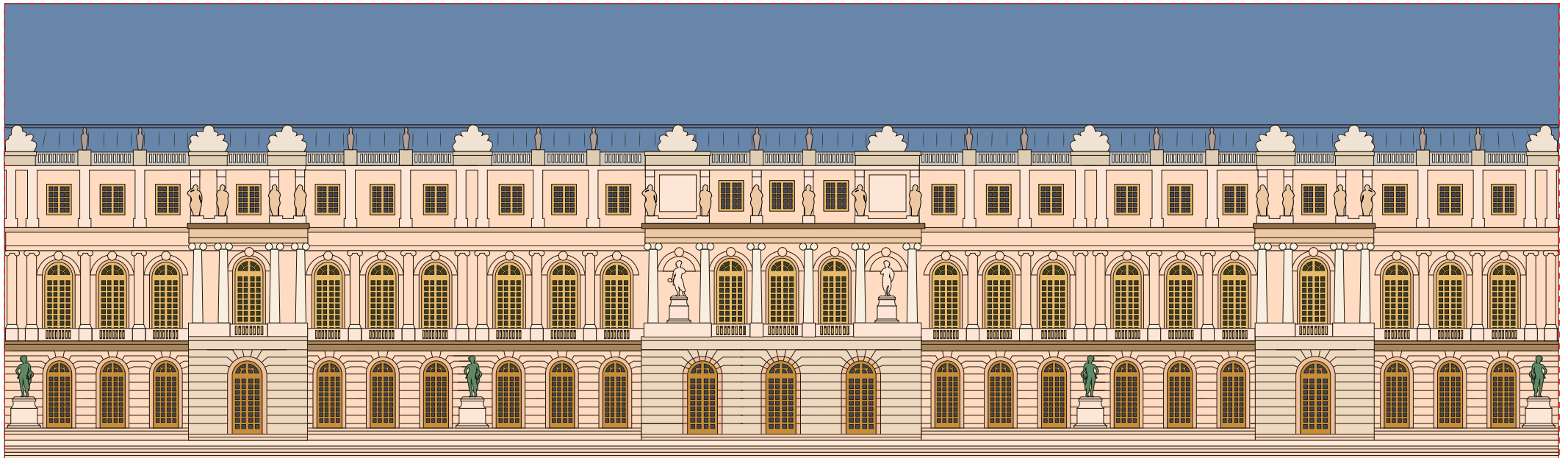

தாகារ

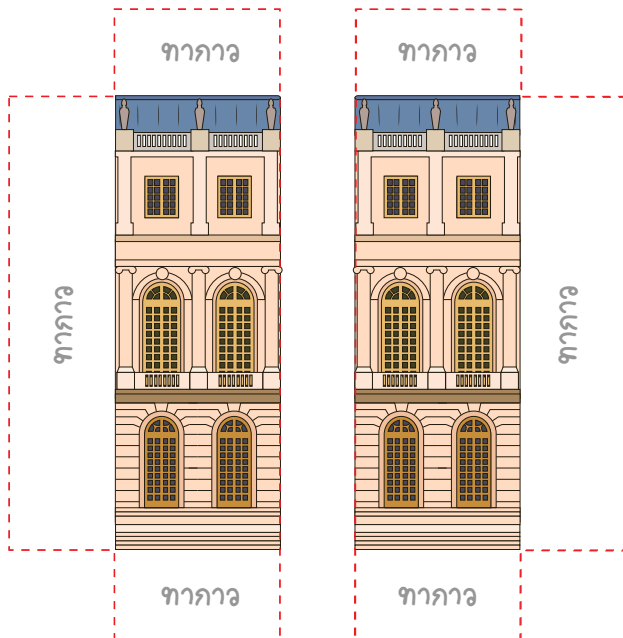

தாகარ

தாகარ

தாகარ

தாகარ

When built 1624

One unique fact
The Palace of Versailles has been listed as a World Heritage Site for 40 years and is one of the greatest achievements in French 17th century art.

Why was it built
It was initially built as a small hunting lodge but has had considerable expansions since that time.

தாகარ

தாகარ

தாகარ

