

# Dilophosaurus

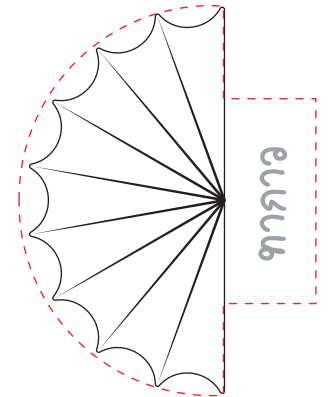

Scan for  
directions

# Tyrannosaurus rex

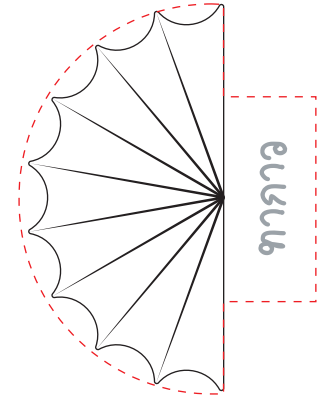
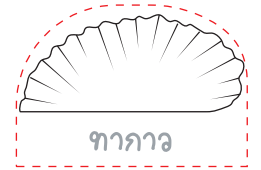
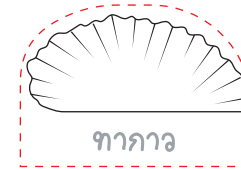
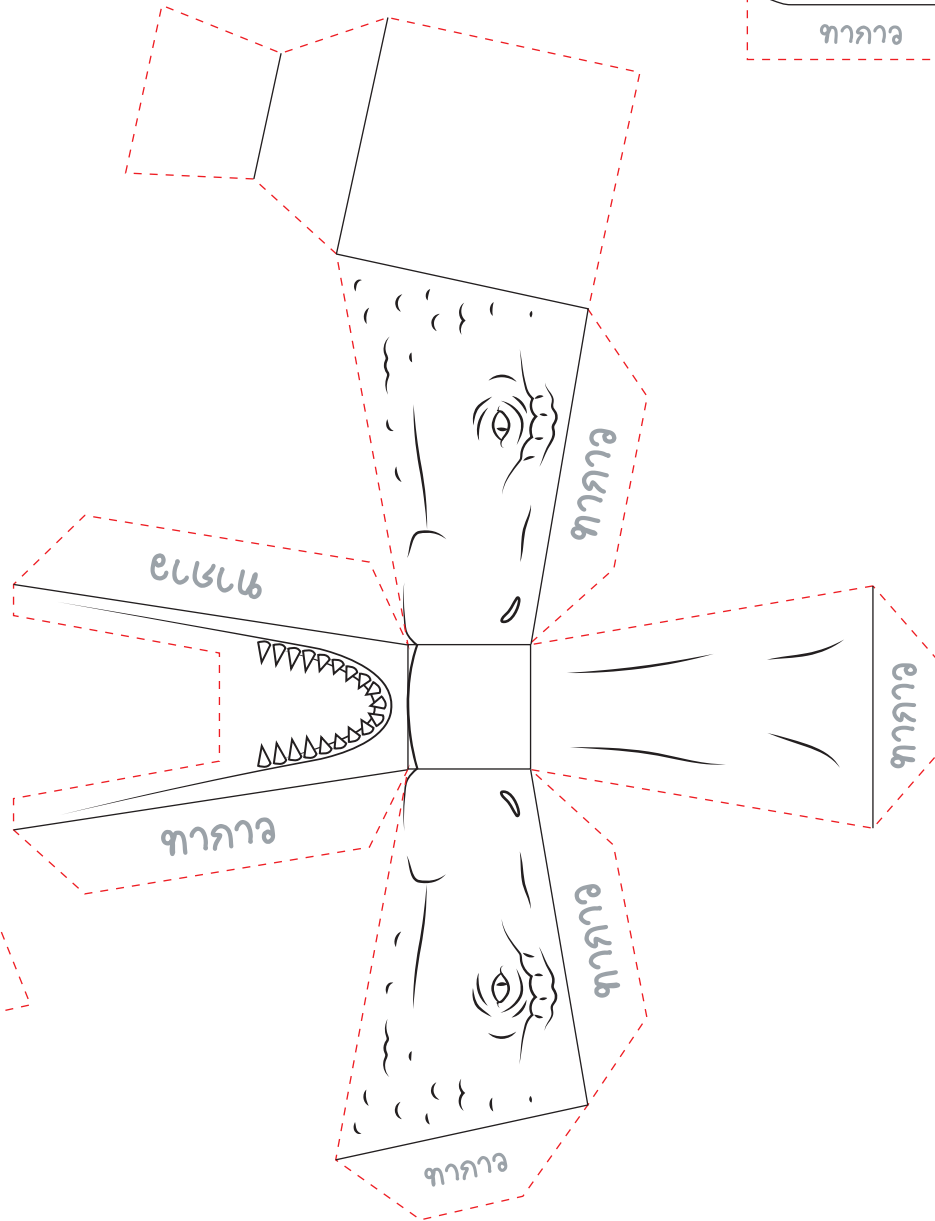
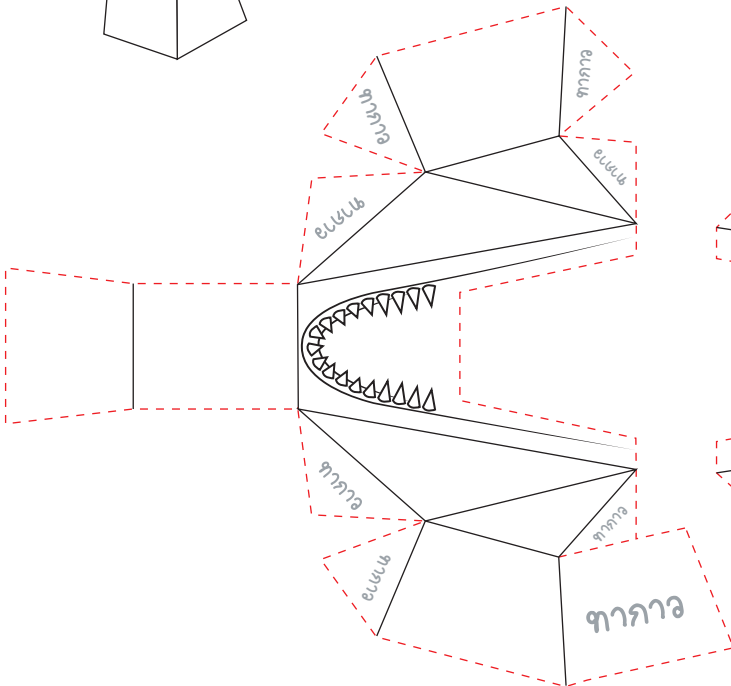
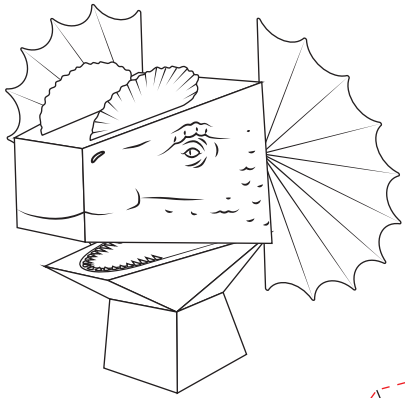
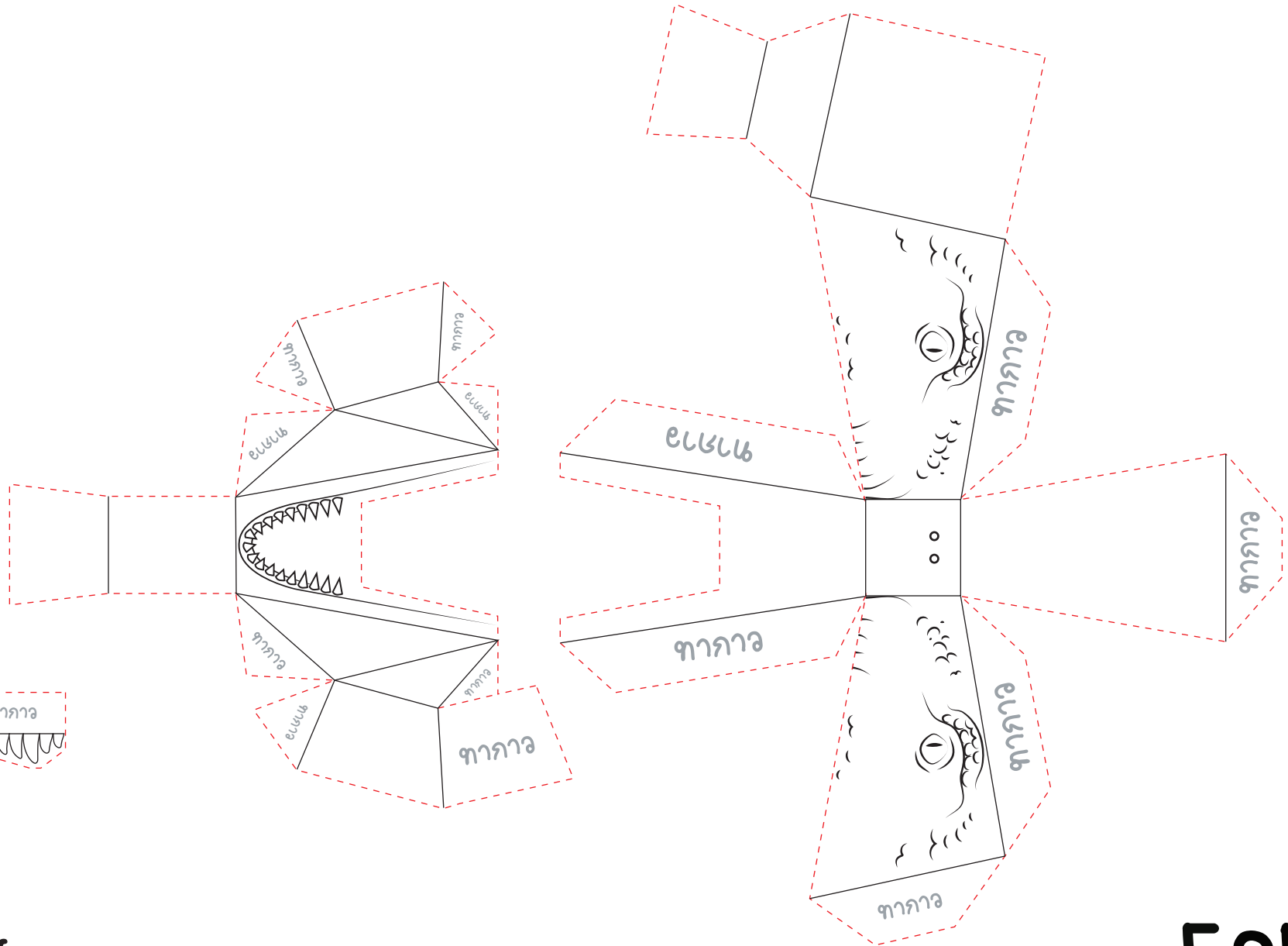
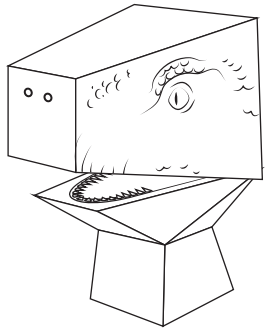

Scan for  
directions

# Triceratops

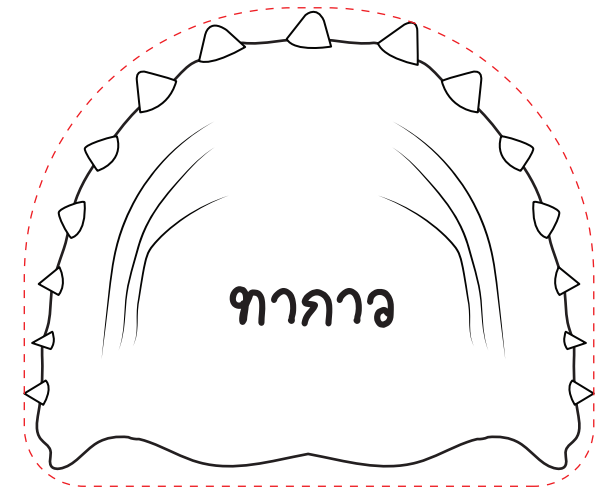
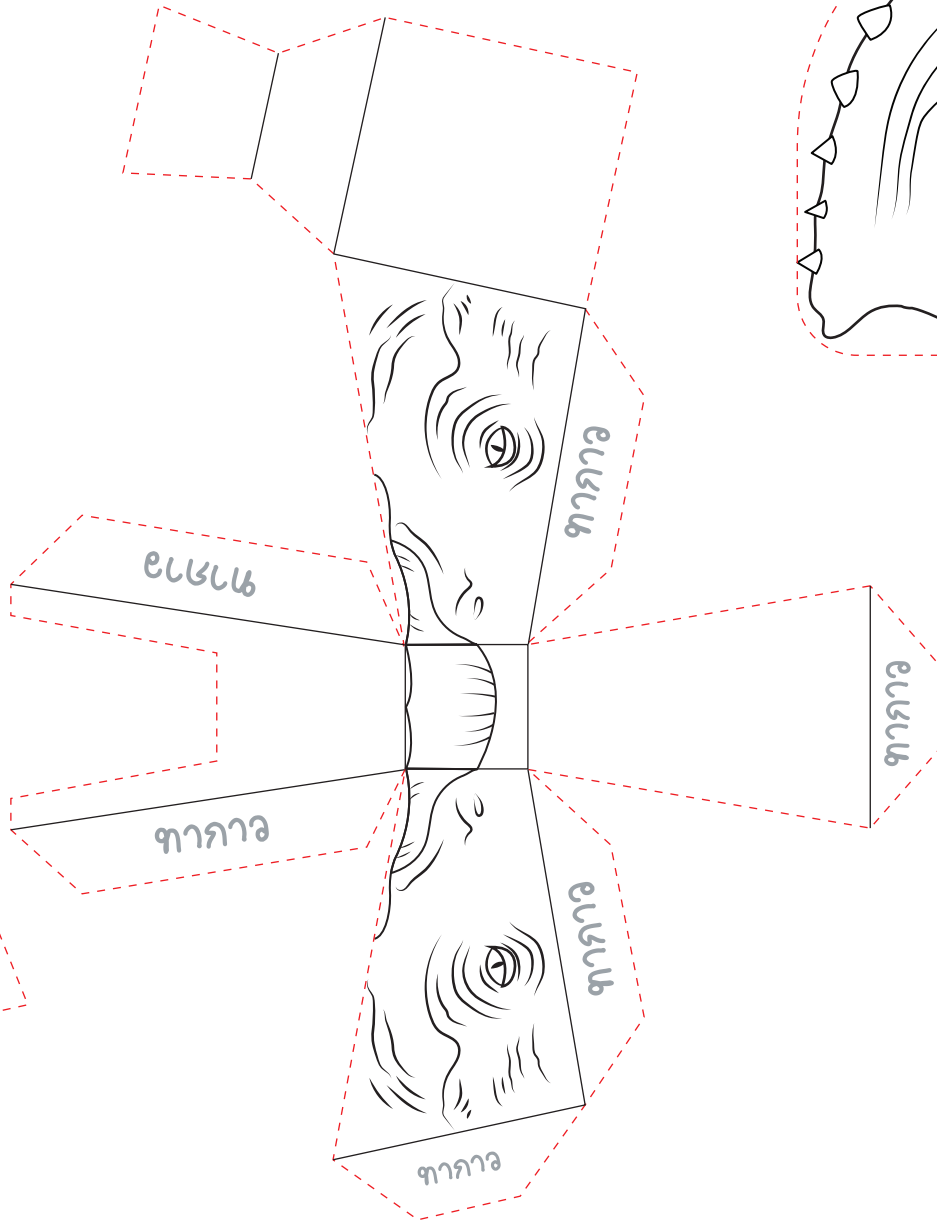
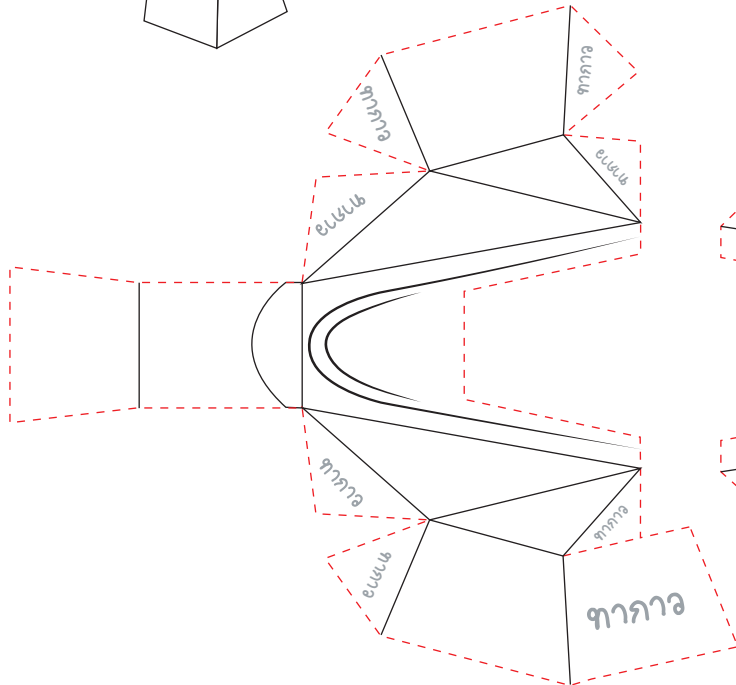
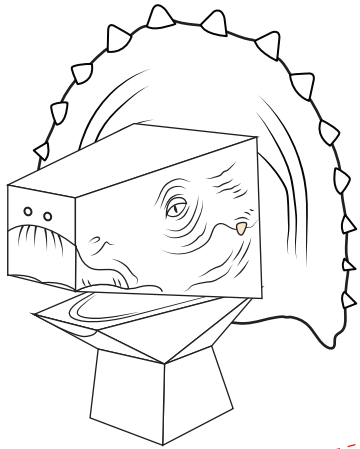

Scan for  
directions

# Stegosaurus

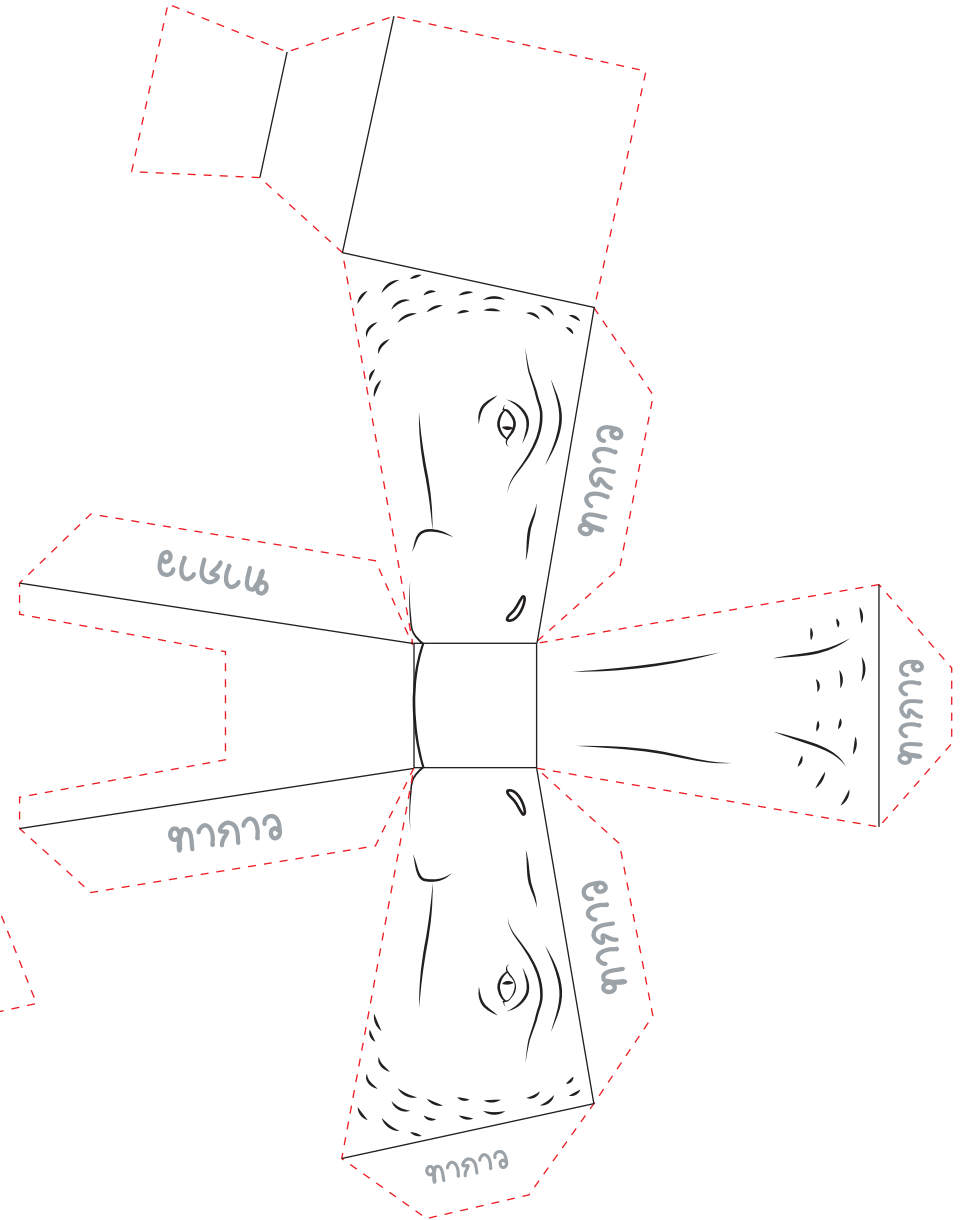
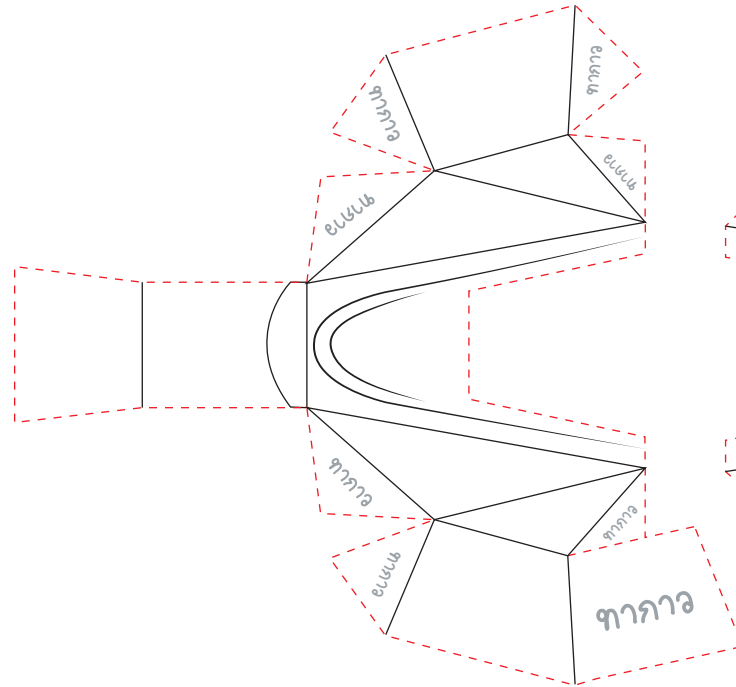
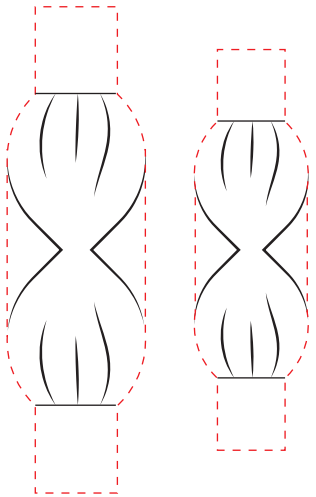
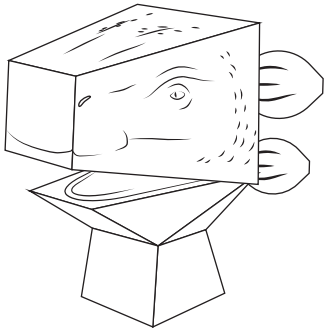

Scan for  
directions

# Parasaurolophus

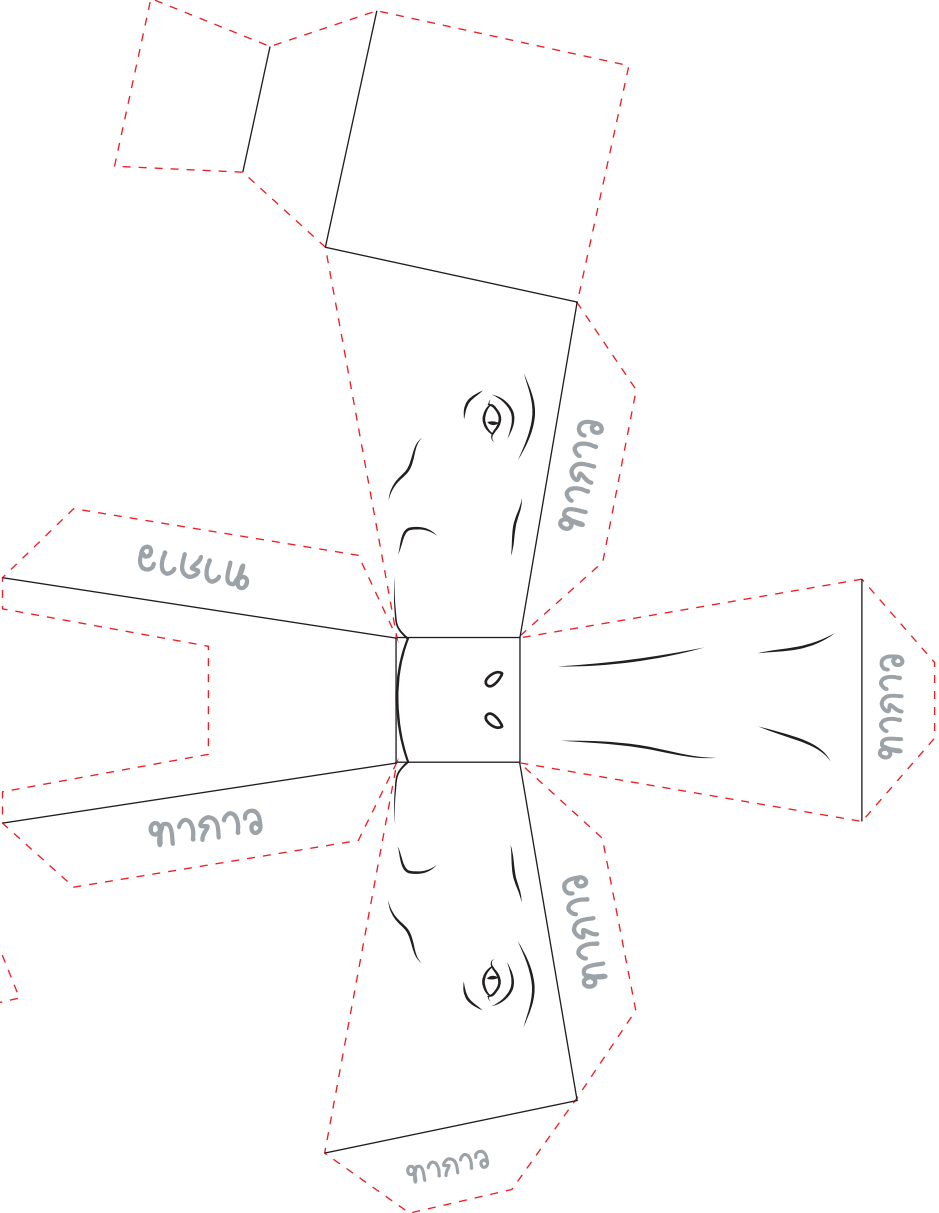
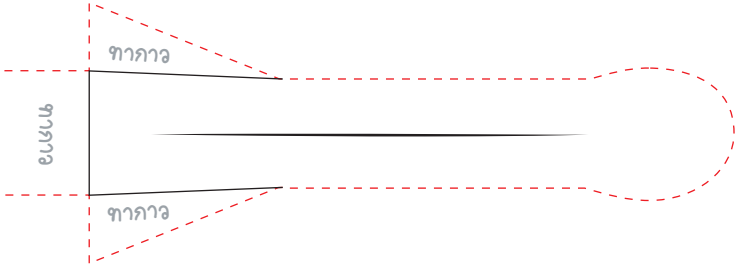
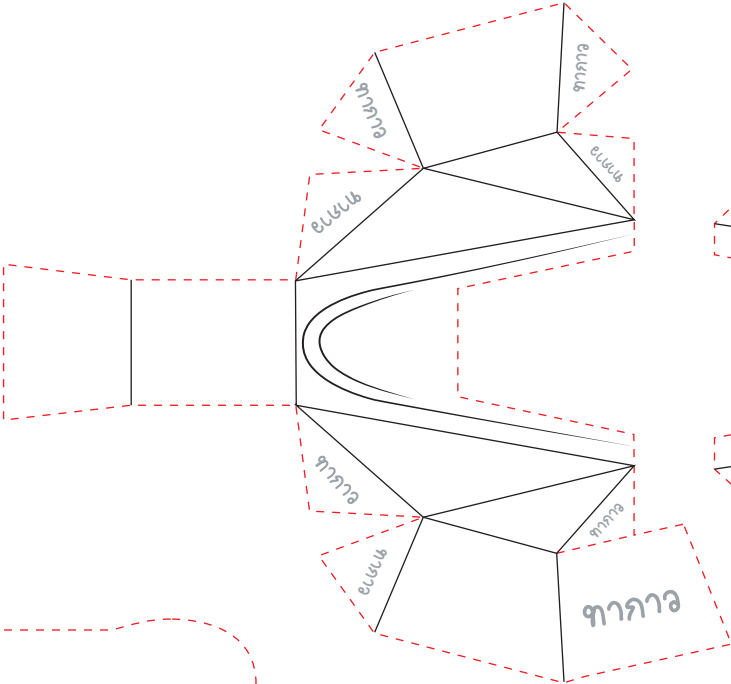
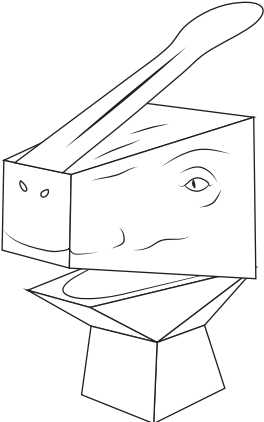

Scan for directions

# Dilophosaurus

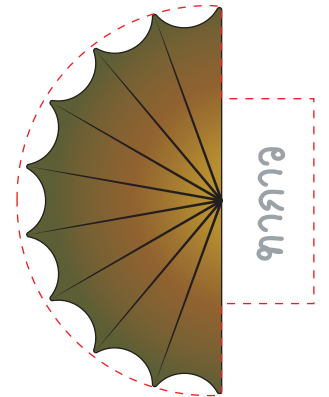
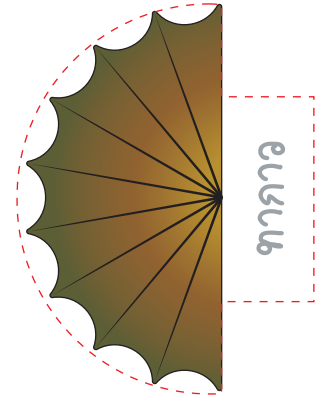
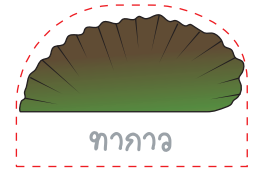
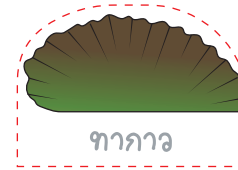
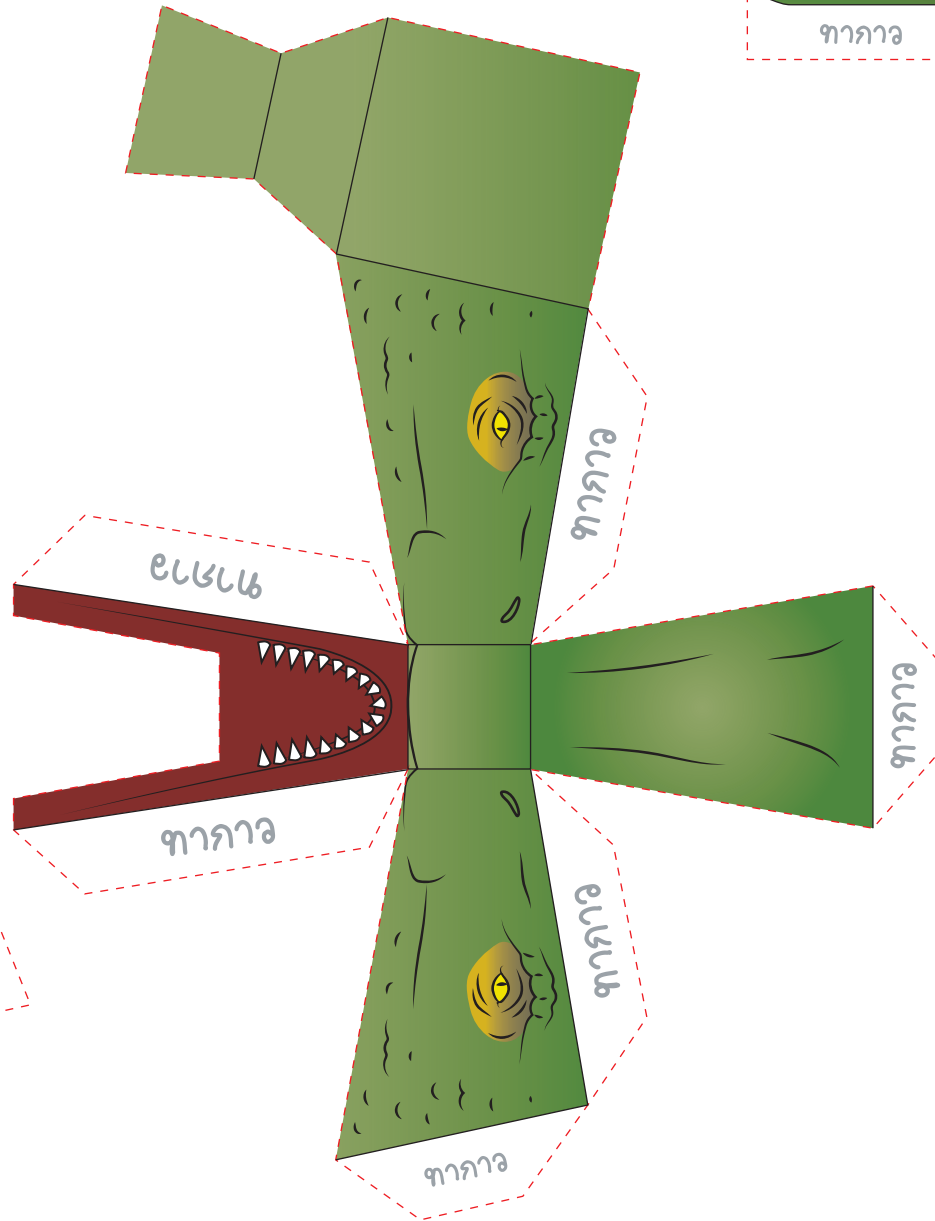
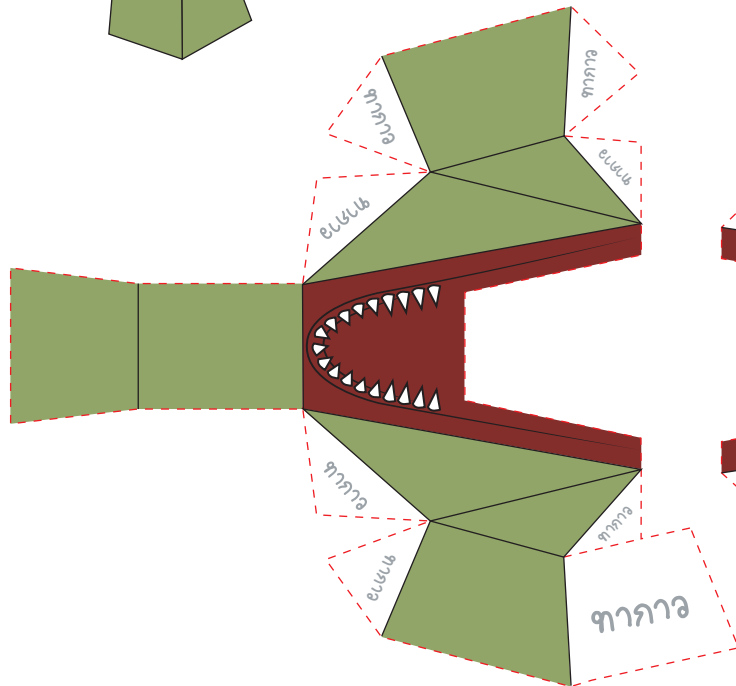
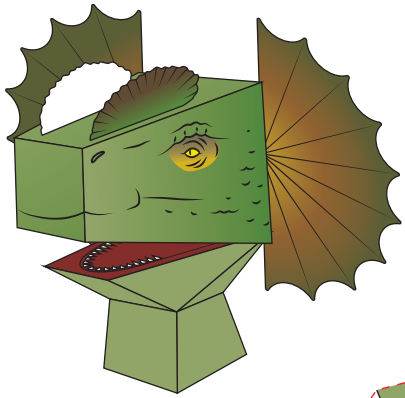

Scan for directions

# Tyrannosaurus rex

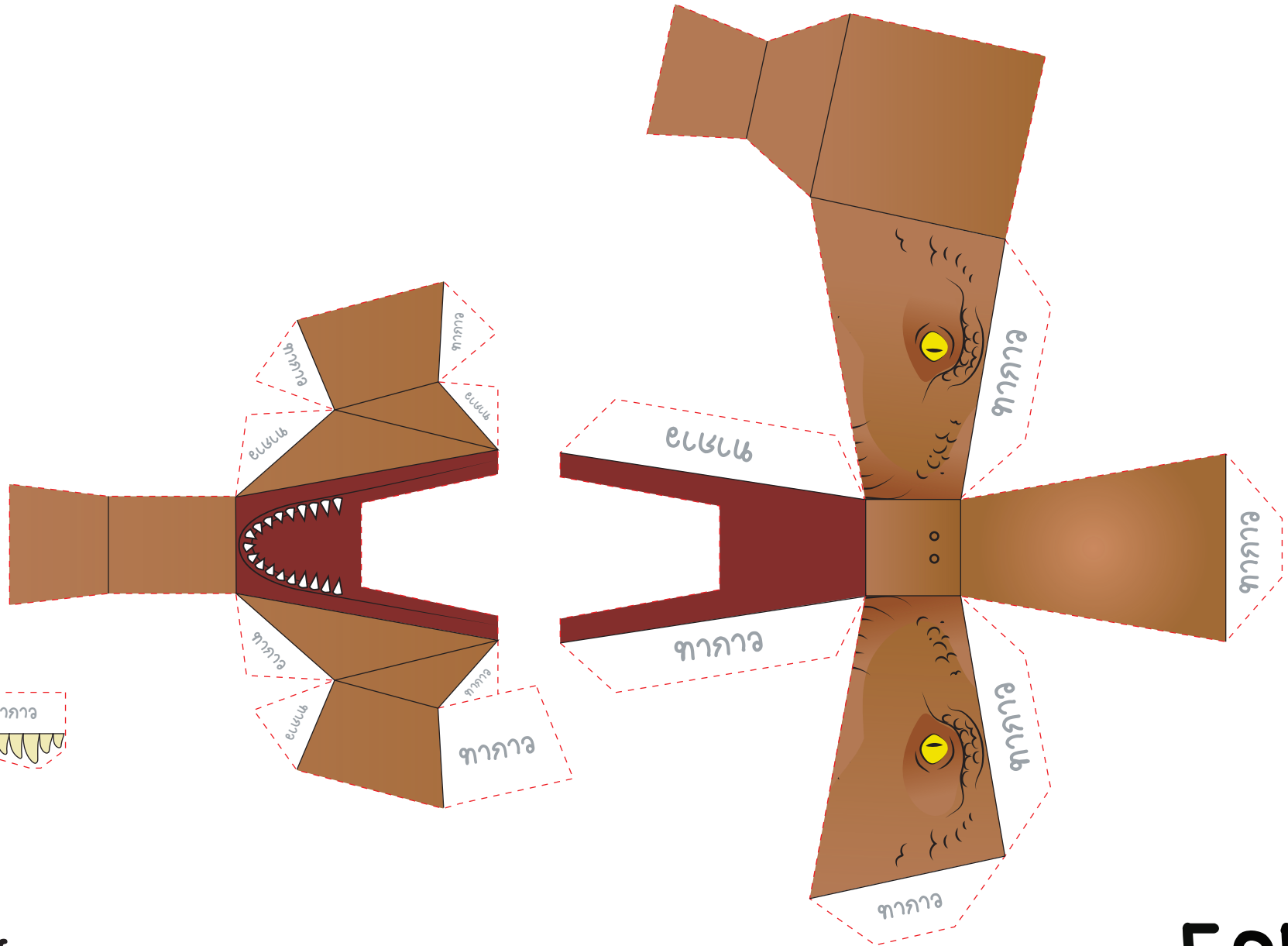
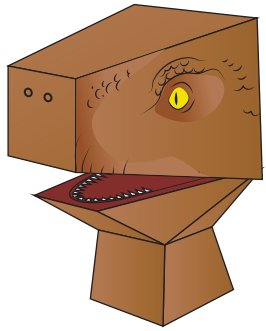

Scan for  
directions

# Triceratops

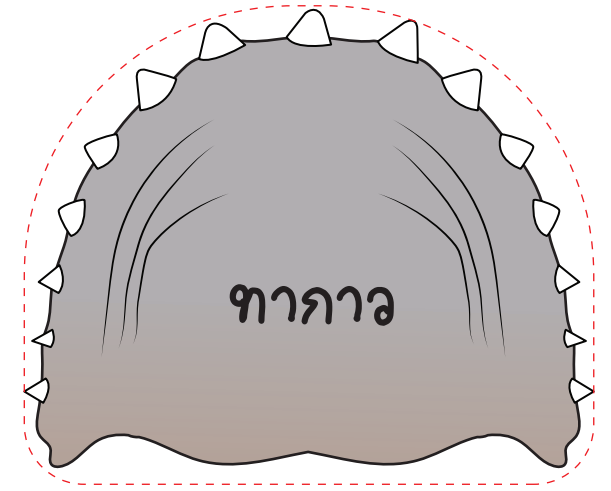
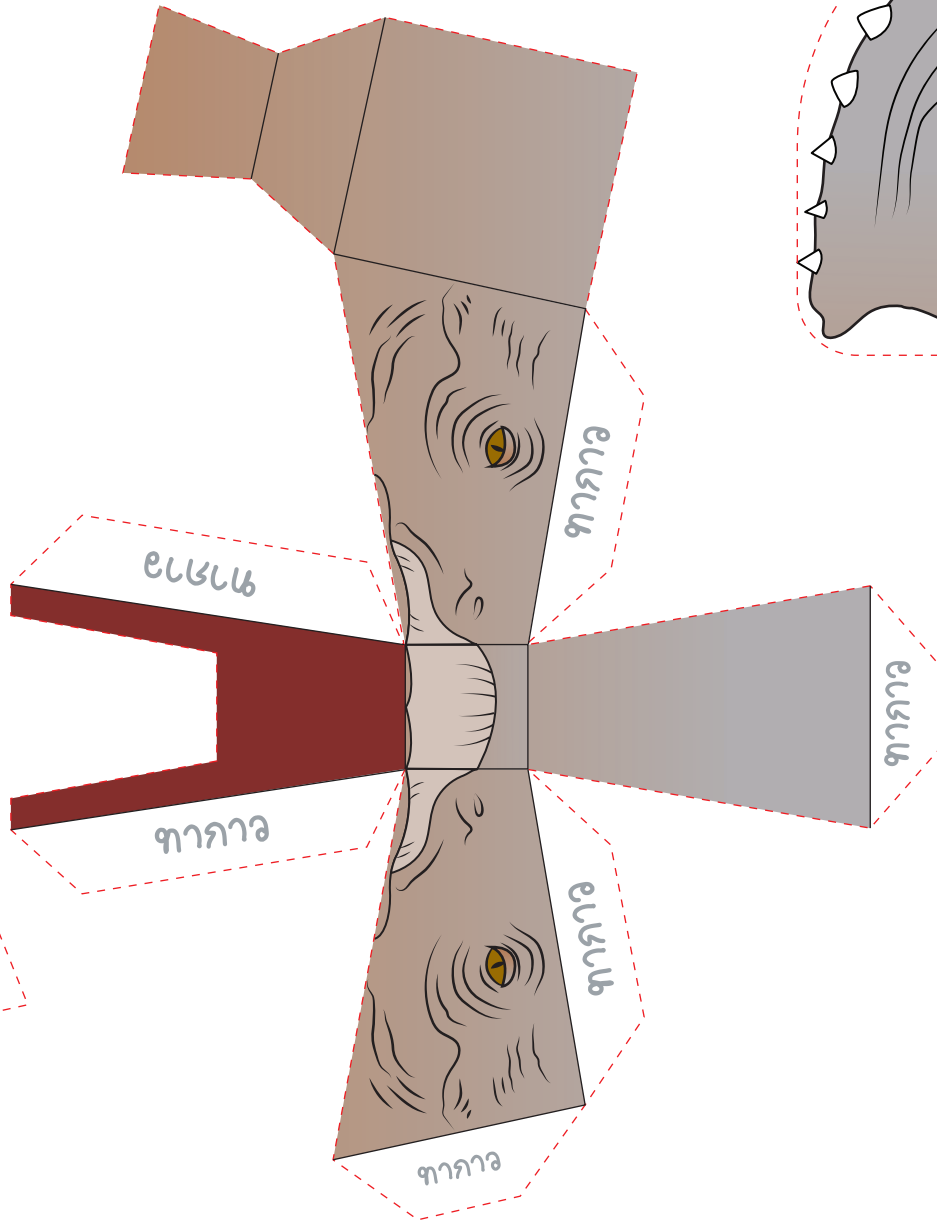
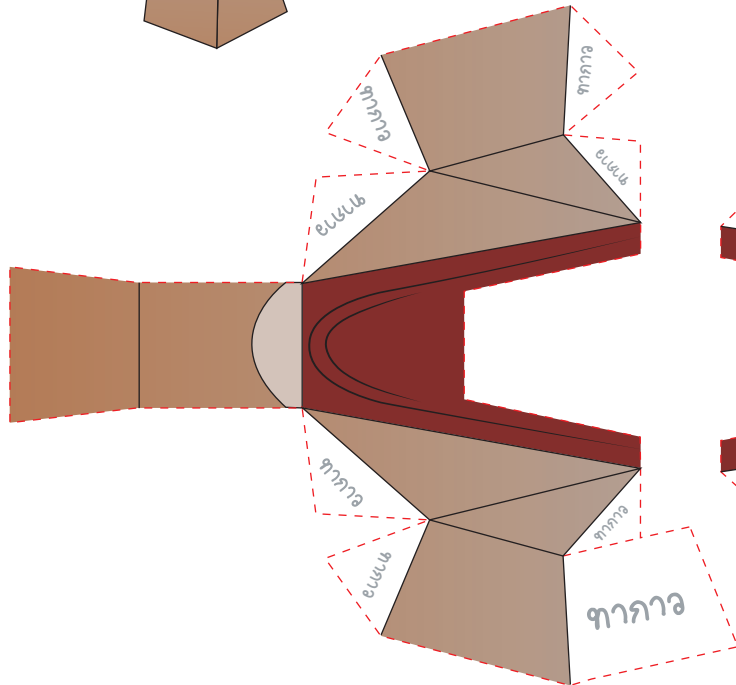
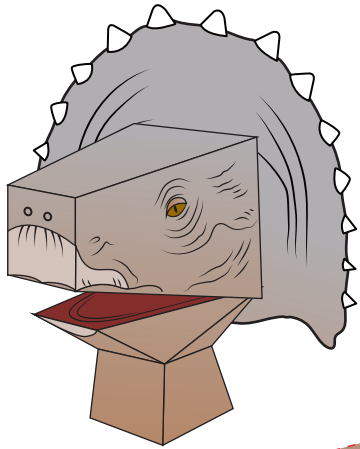

Scan for  
directions



# Stegosaurus

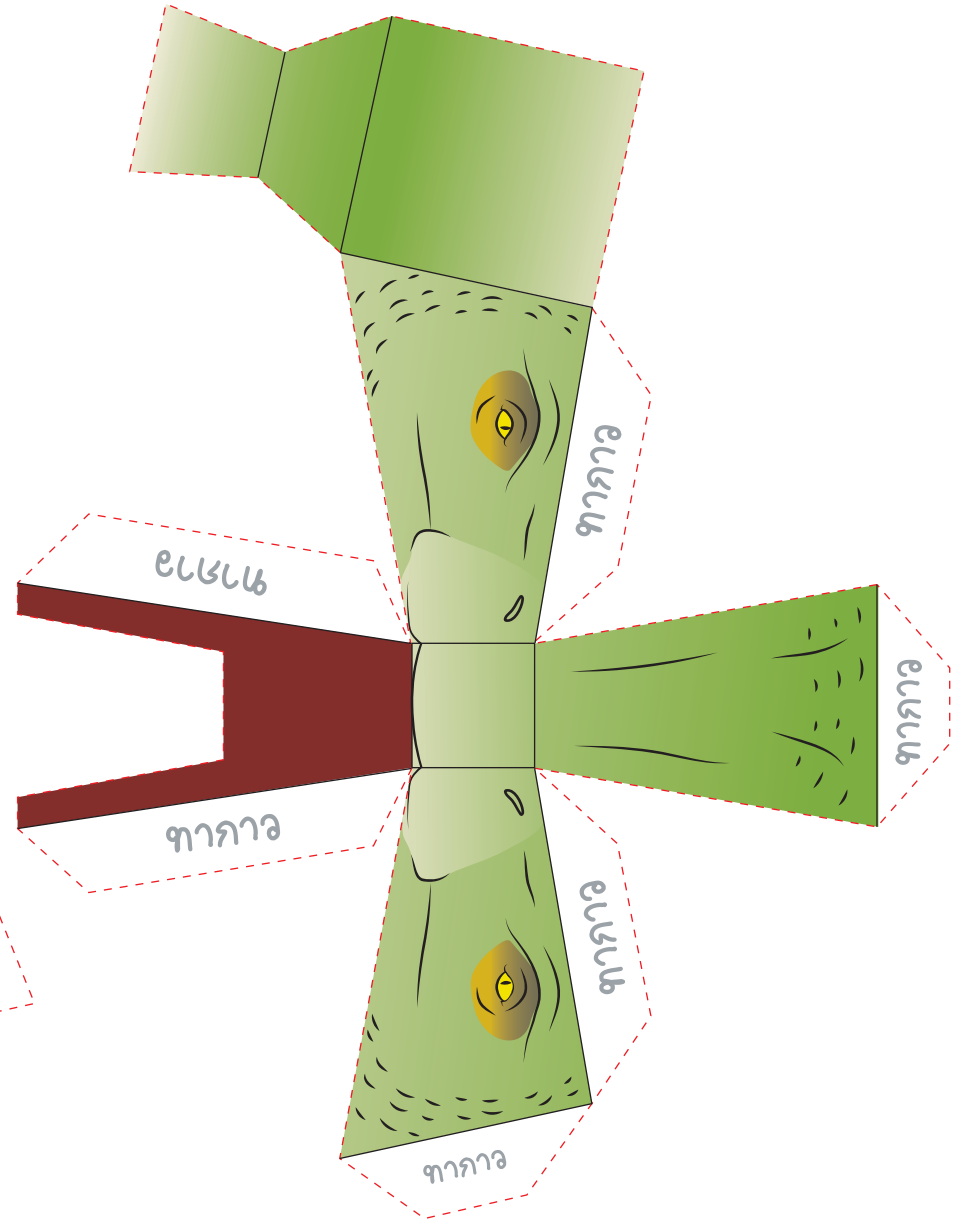
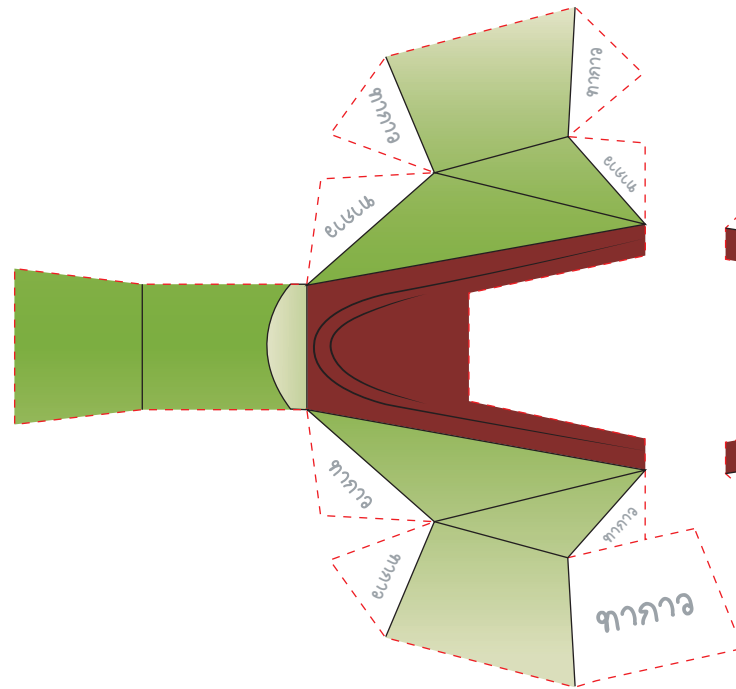
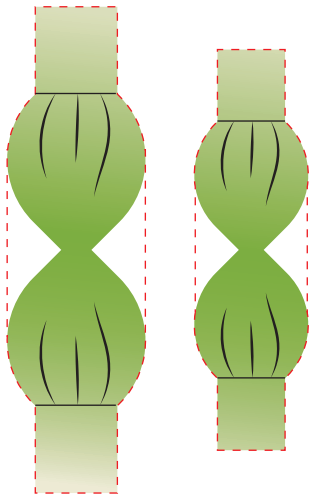
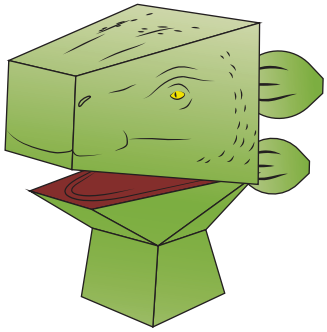

Scan for directions

# Parasaurolophus

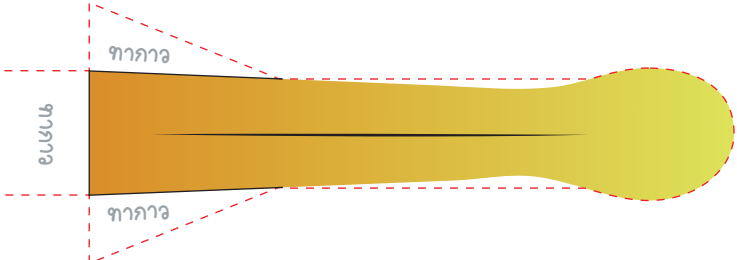
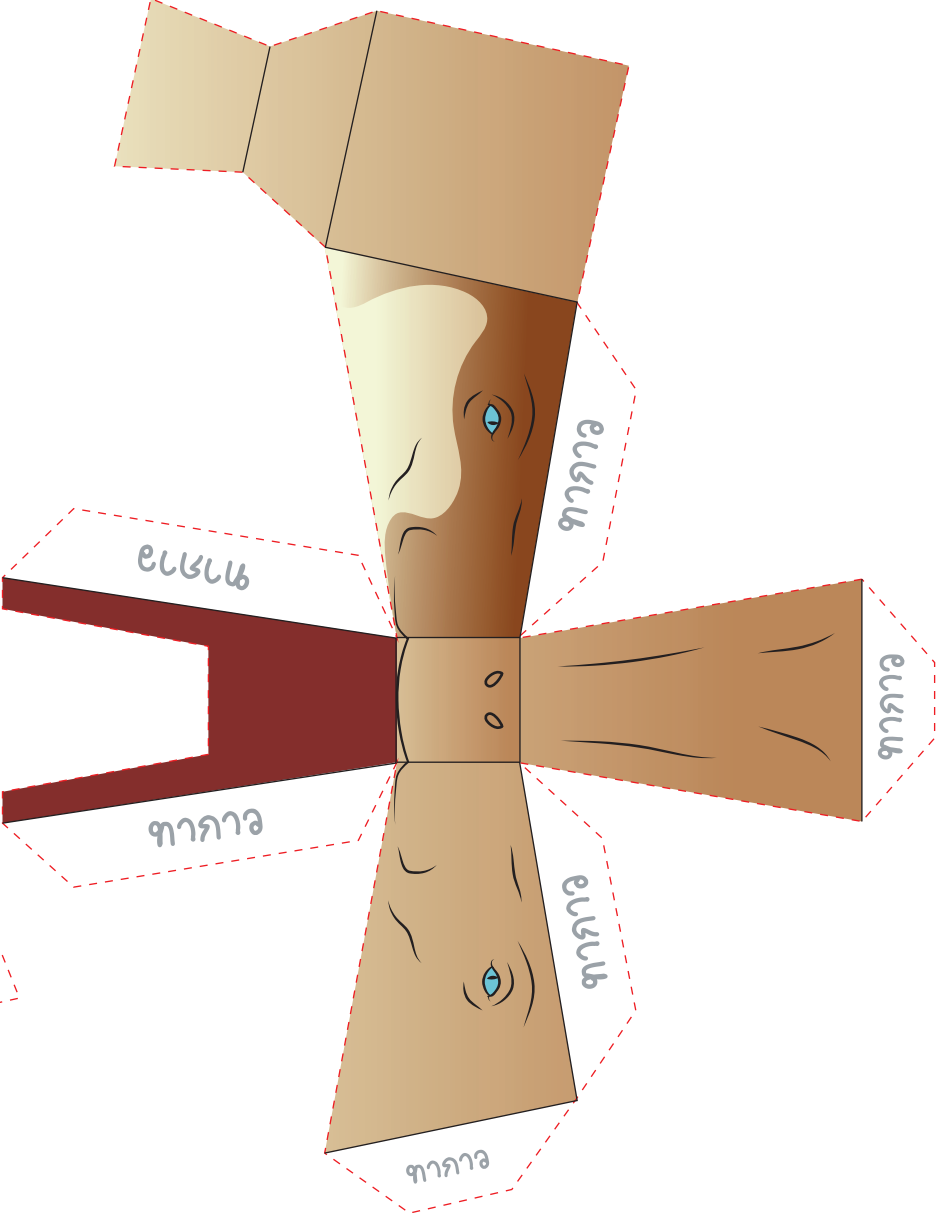
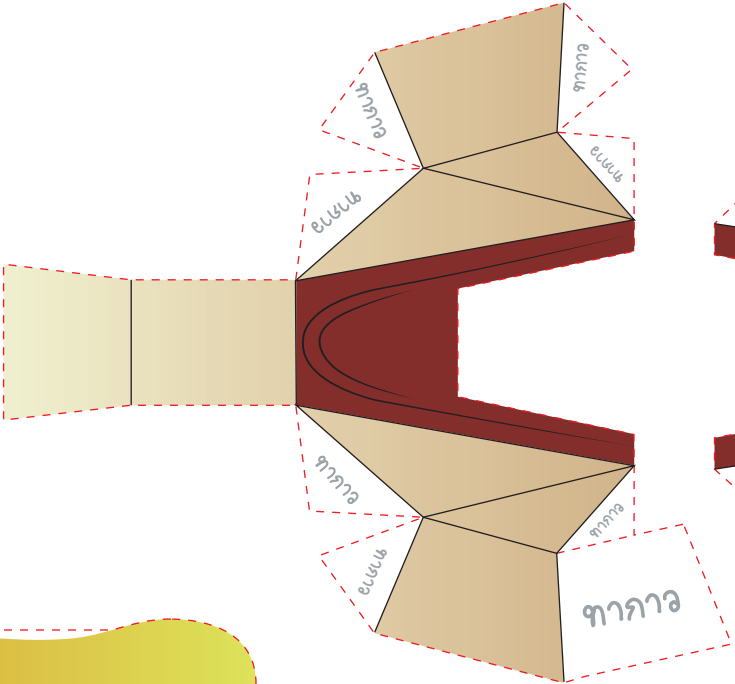
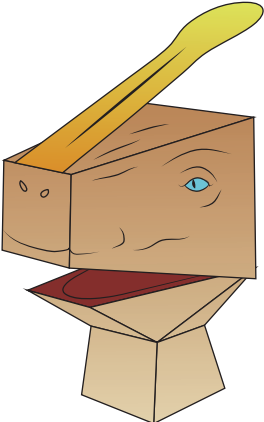

Scan for directions

# How to make puppet

## Set1

Step 1

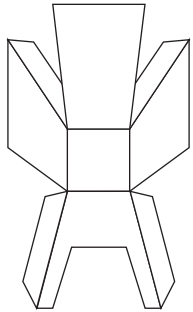

Step 2

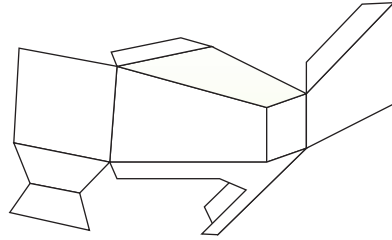

Step 3

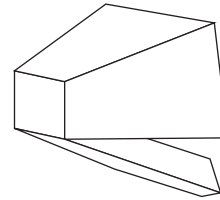

Step 4

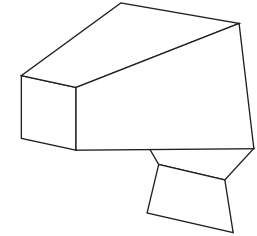
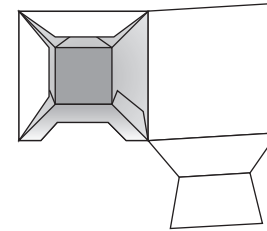

## Set2

Step 1

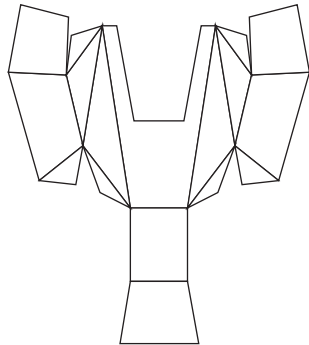

Step 2

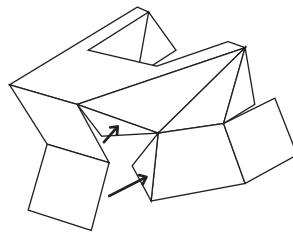

Step 3

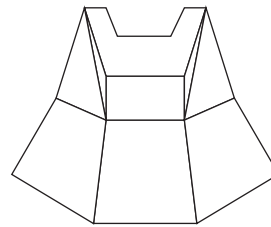

Step 4

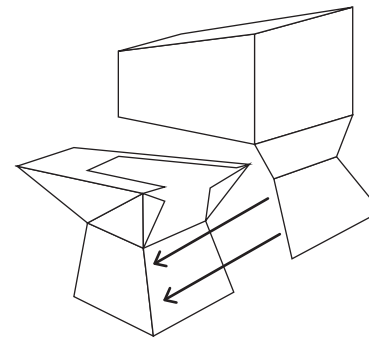

Finish

