

# Vocabulary คำศัพท์

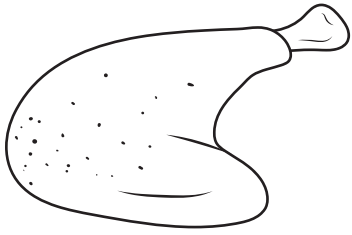

Chicken

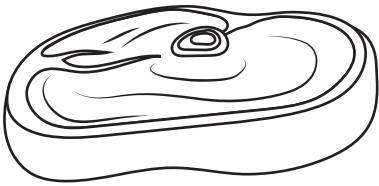

Pork

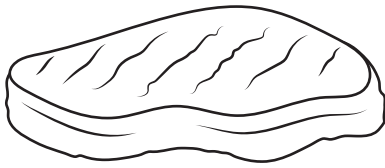

Beef

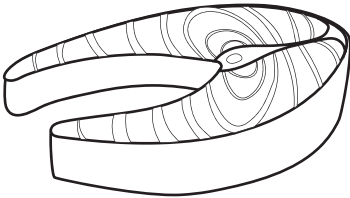

Fish

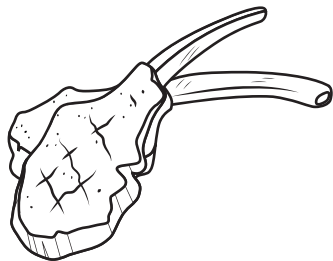

Lamb chop

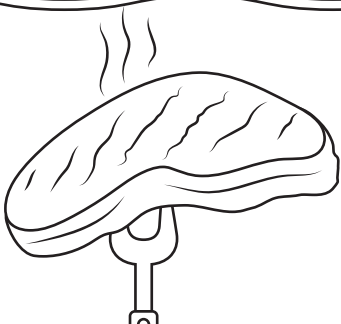

# Match the meat to the animal

จับคู่คำศัพท์

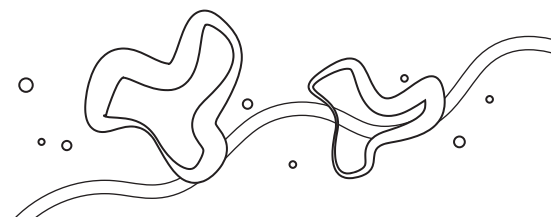
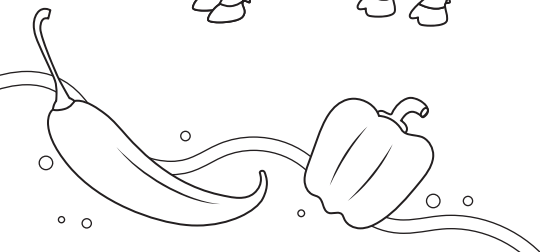
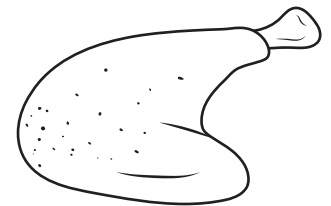
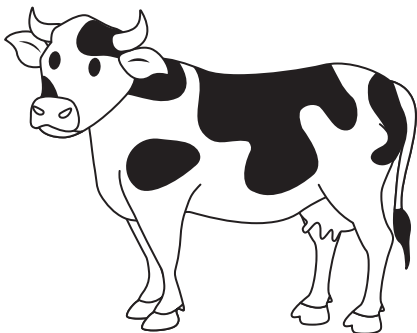
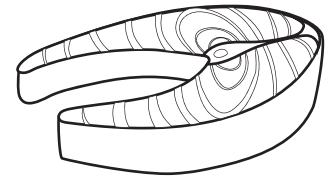
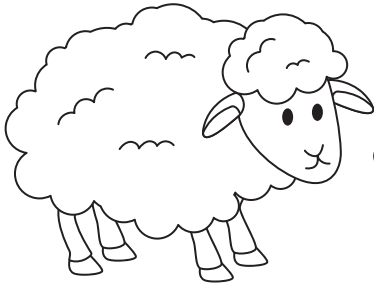
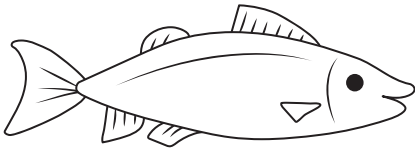
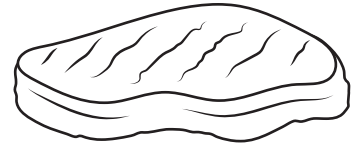
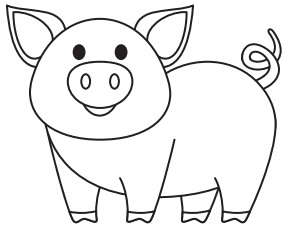
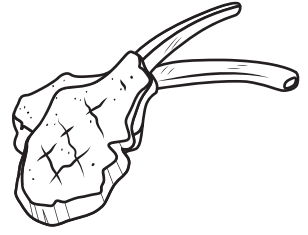
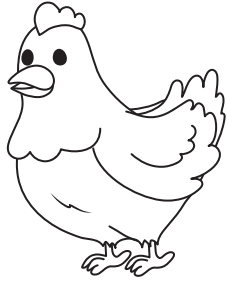

# Unscramble the words and make a sentence

เขียนคำศัพท์ให้ถูกต้อง

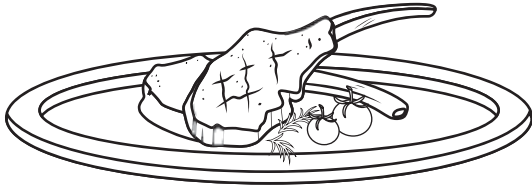

balm hpoc



kpor



hkceicn

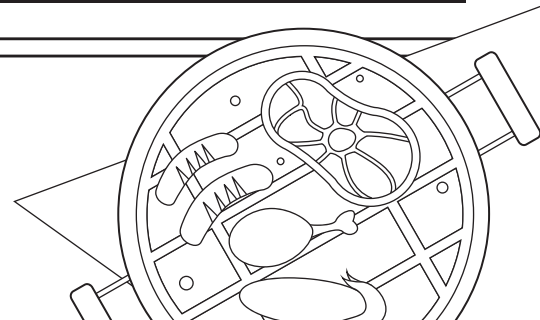
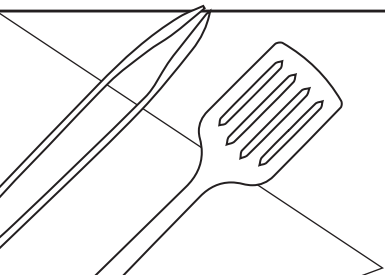

# Unscramble the words and make a sentence

เขียนคำศัพท์ให้ถูกต้อง

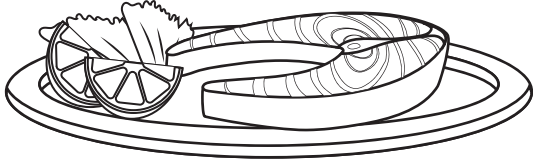

hsfi

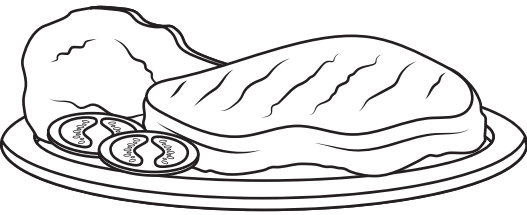

fbee

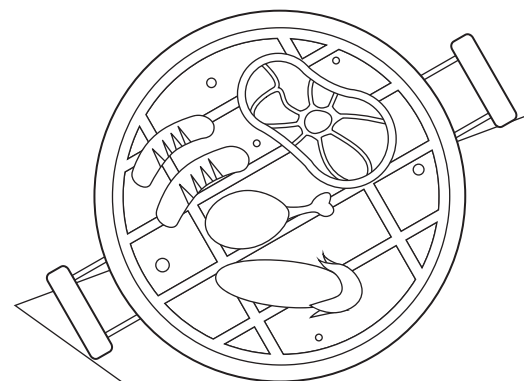
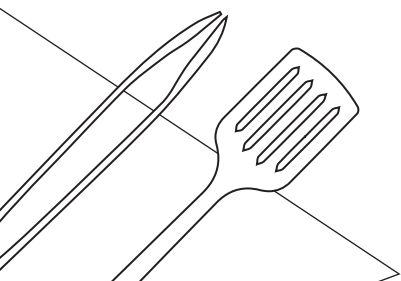

# Answer the Questions ตอบคำถามให้ถูกต้อง

1. Have you ever eaten steak? Where?

---

---

2. Do you like steak? Why?

---

---

3. What kind of steak do you like?

---

---

4. What kind of steak do you want to eat?

---

---

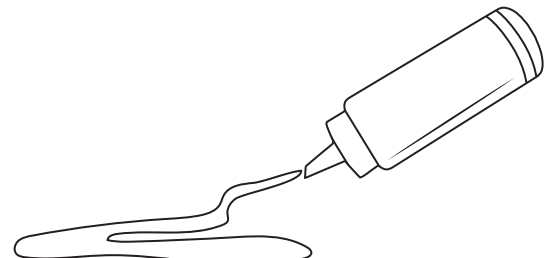
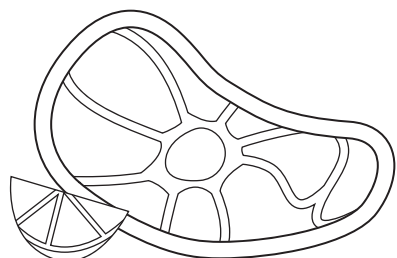

# Answer the Questions ตอบคำถามให้ถูกต้อง

5. What dipping sauces is your favorite?

---

---

6. Do you like to eat your steak rare, medium rare, medium, or well done?

---

---

7. Can you cook a steak?

---

---

8. How often do you eat steak?

---

---

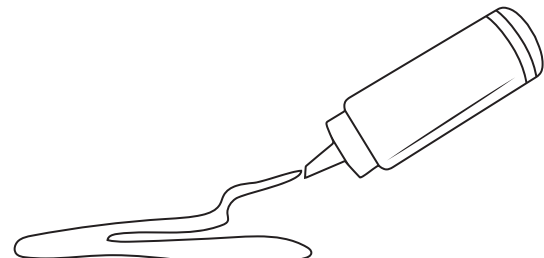
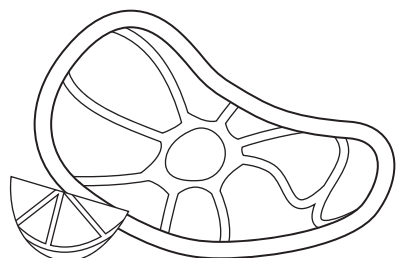

# Choose the correct answer

เลือกคำตอบให้ถูกต้อง

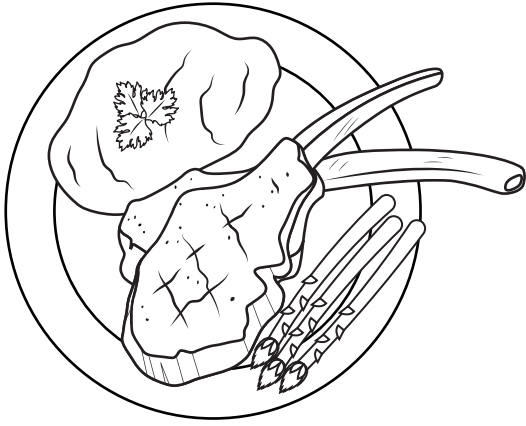

- Lamb chops with mashed potatoes and asparagus.
- Lamb chops with french fries and bacon.



- Grilled pork with a fresh vegetable salad.
- Grilled pork with french fries and tomato sauce.



- Chicken steak with lemon and lettuce.
- Chicken steak with corn.



# Choose the correct answer

เลือกคำตอบให้ถูกต้อง



- Grilled beef steak and colorful peppers.
- Beef steak with broccoli and onions.



- Salmon with spinach and beans.
- Salmon with mushroom sauce and lemon.





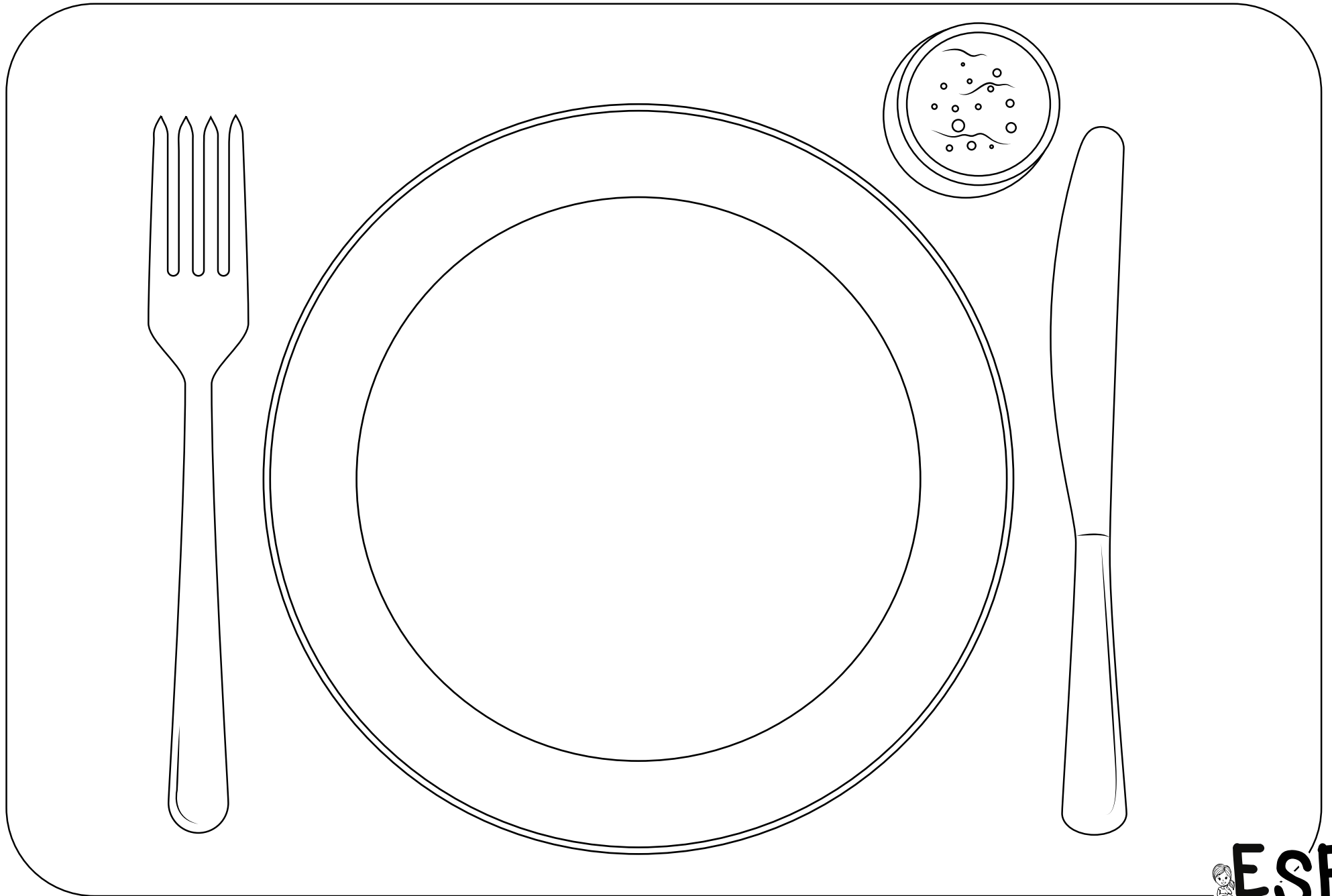

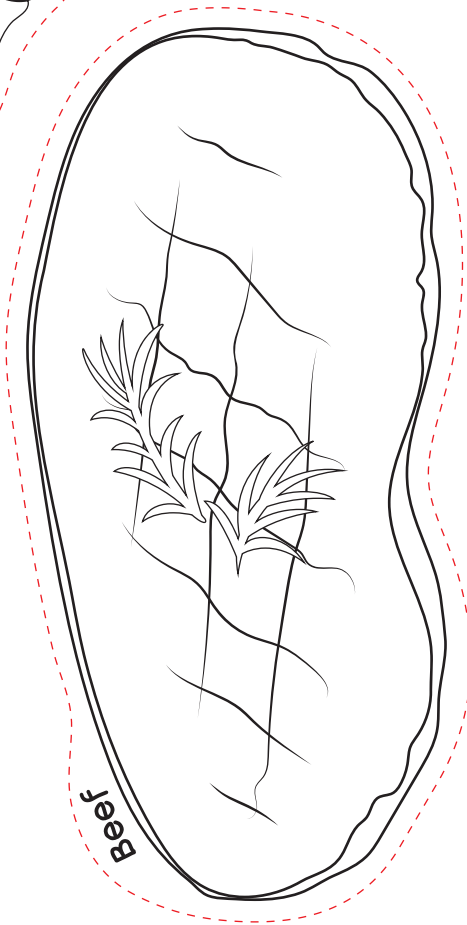
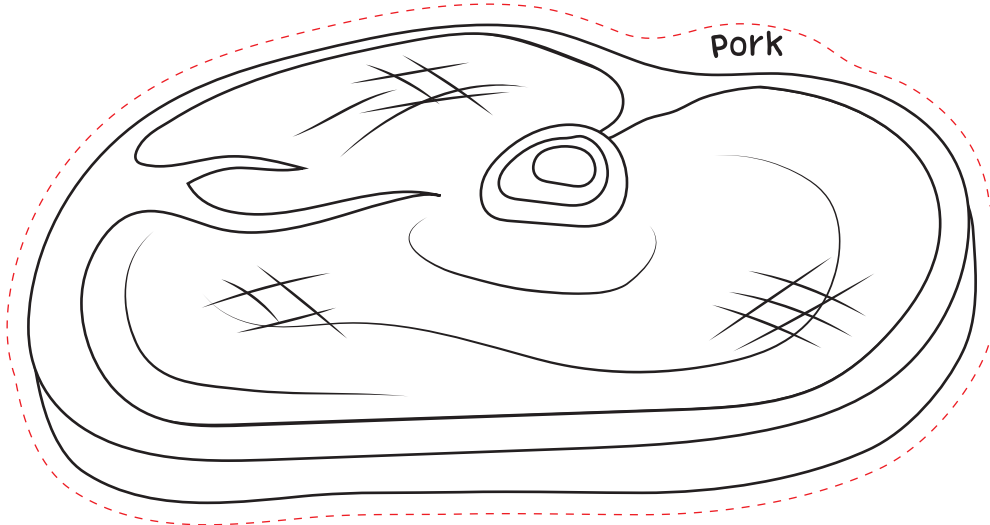
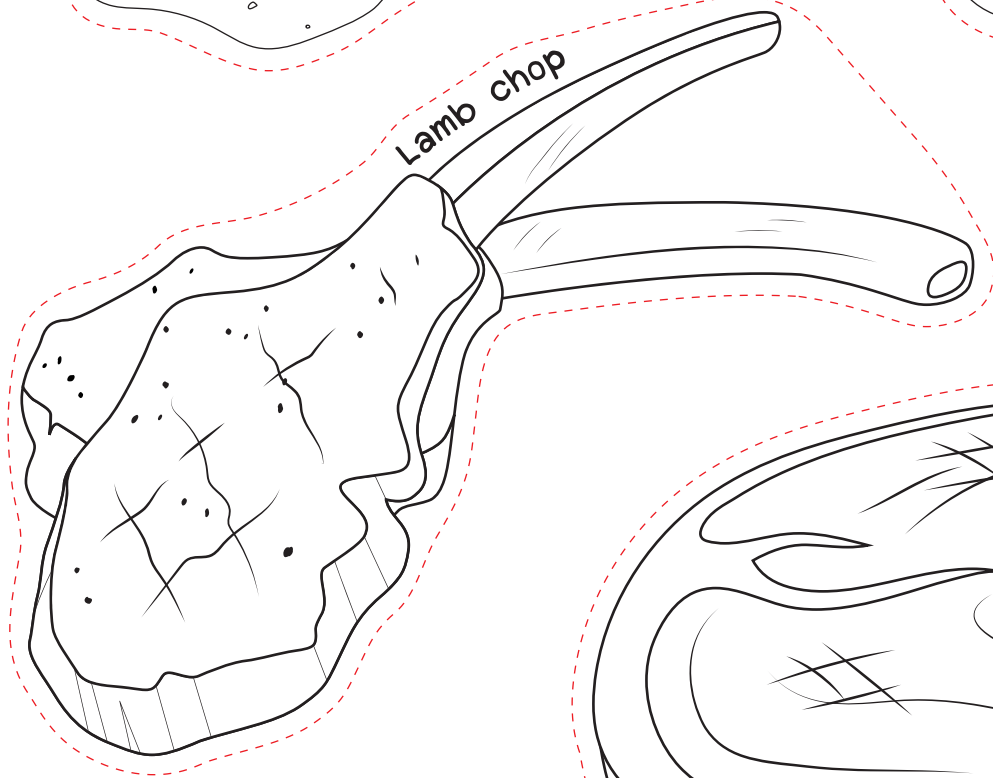
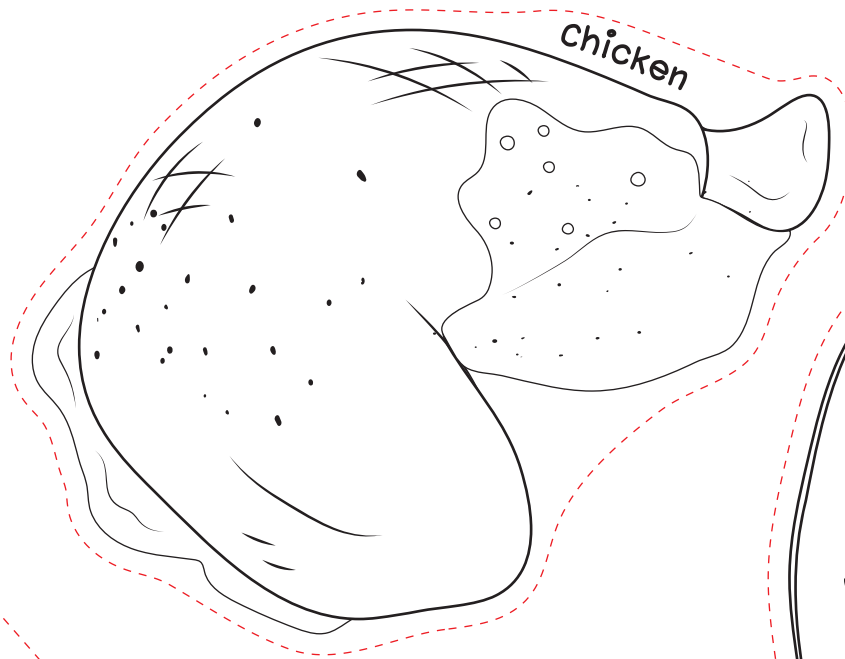
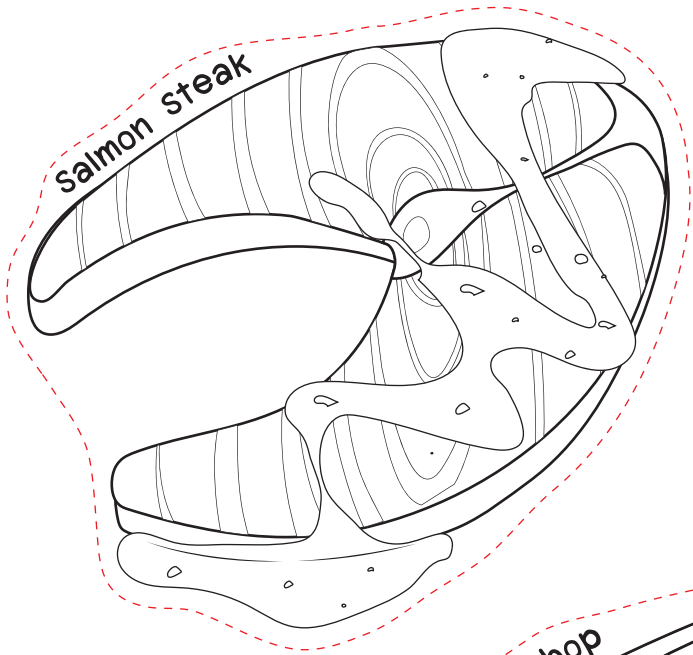

French fries

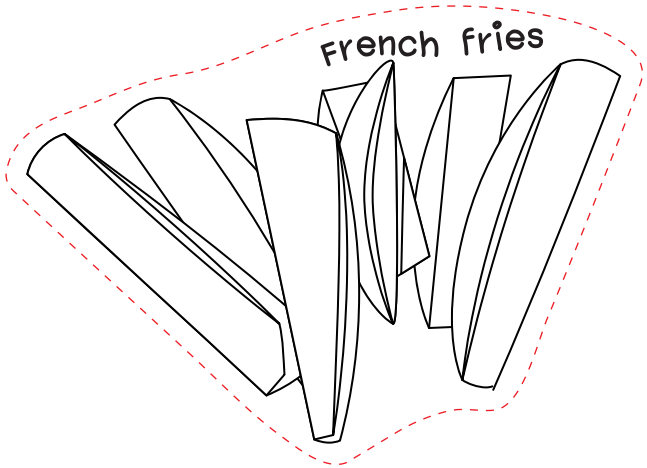

Lettuce

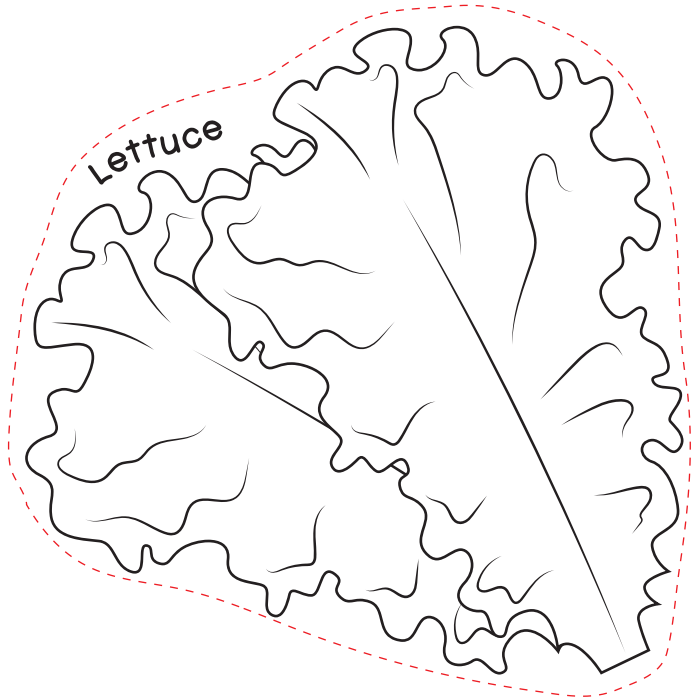

Bacon

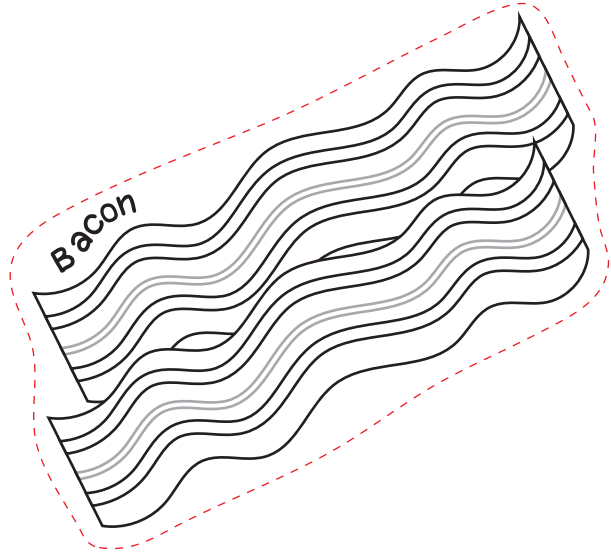

Tomatoes

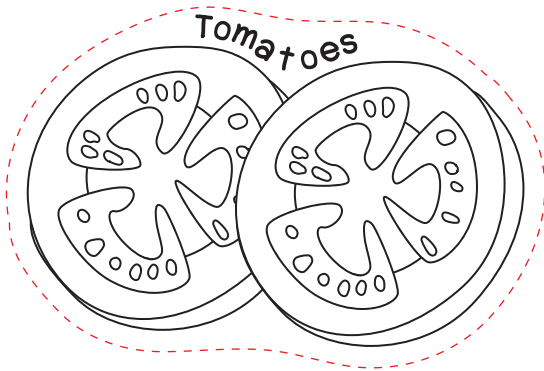

Mashed Potatoes

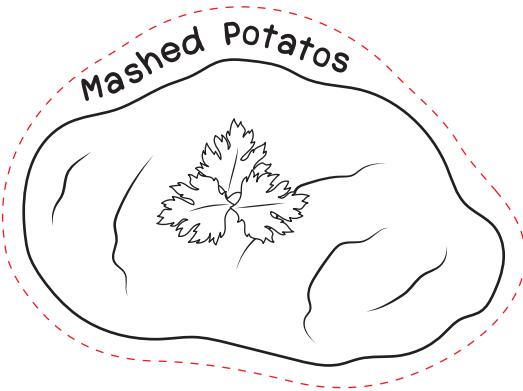

Sausage

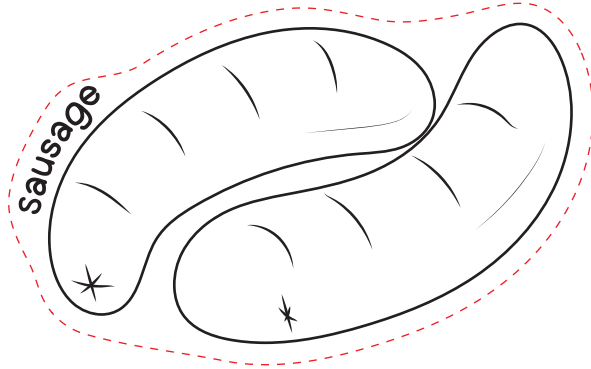

Lemons

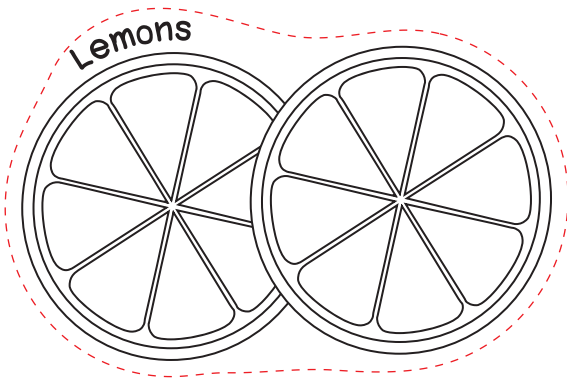

Asparagus

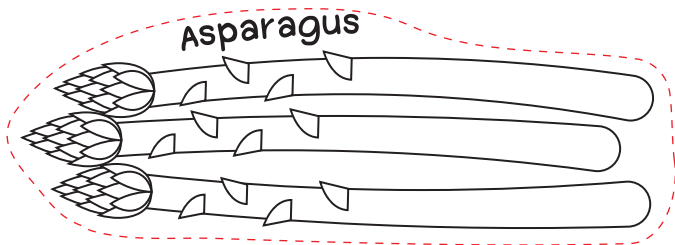

# Steak Order

1. Grilled beef steak with french fries.
2. Salmon with asparagus and lemon cream sauce.
3. Pork with mashed potatoes.
4. Grilled chicken and bacon with black pepper sauce.
5. Grilled beef steak with sausage mixed grilled vegetables.
6. Pork steak with french fries and salad.
7. Grilled salmon steak with fresh vegetables.
8. Lamb chops with mashed potatoes.

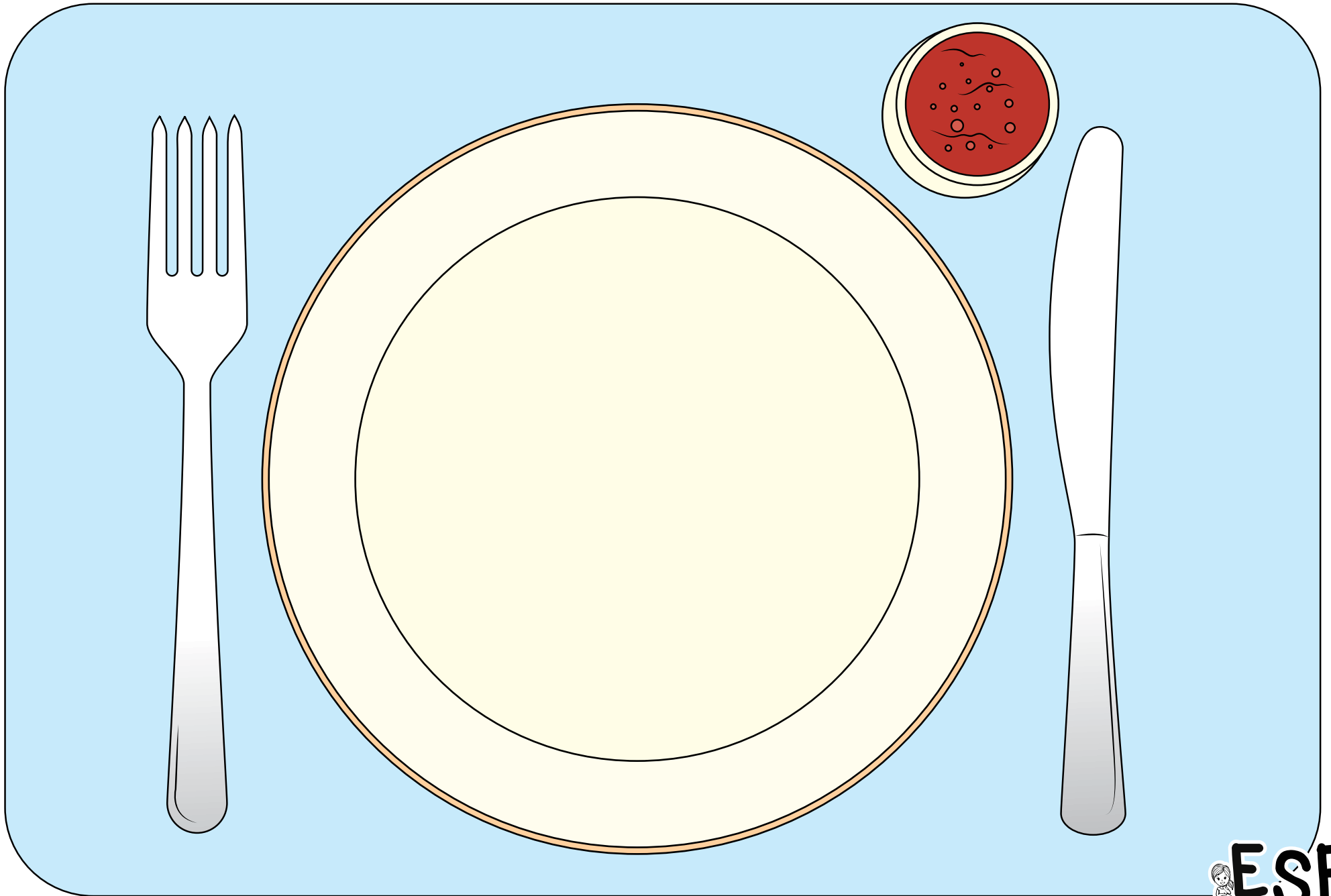

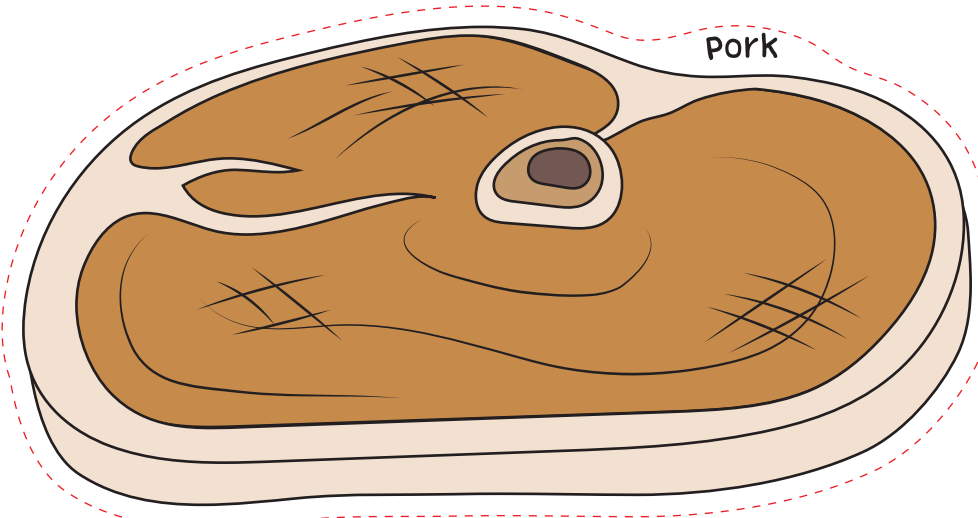
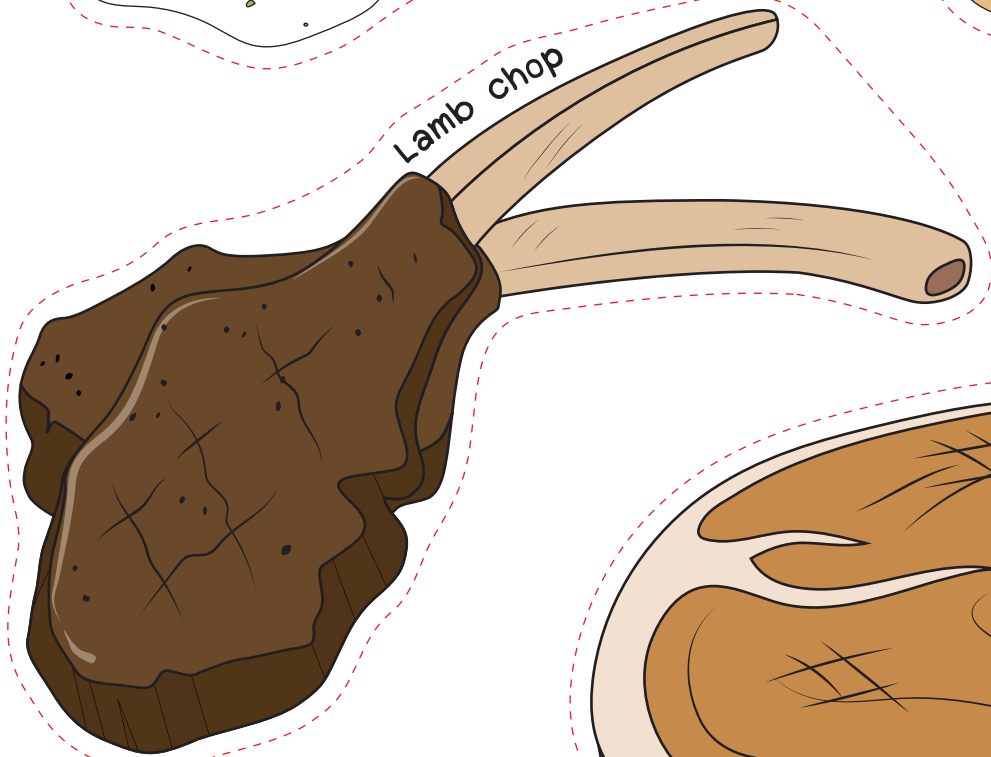
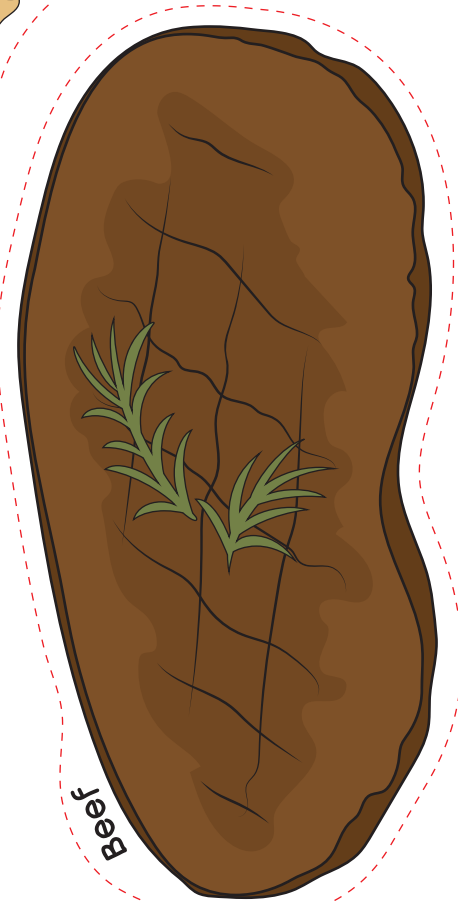
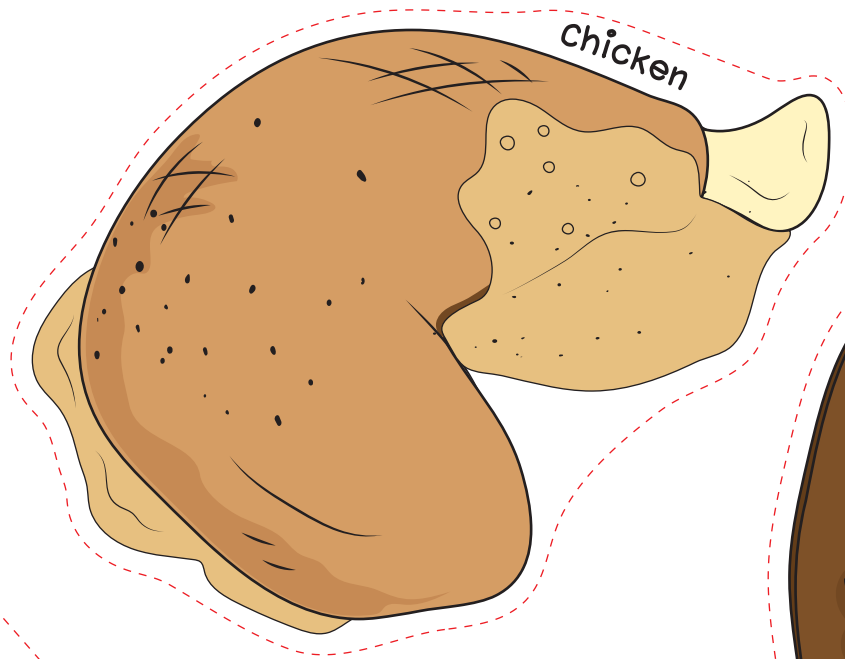
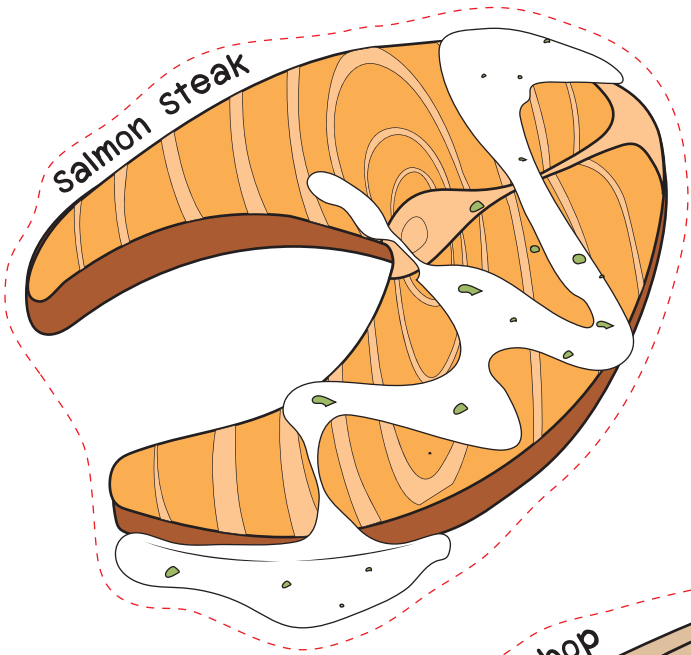

French fries

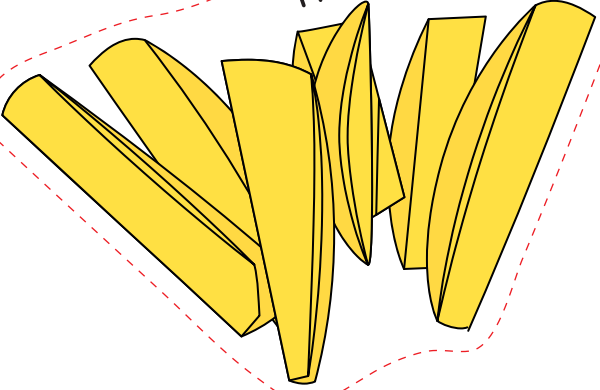

Lettuce

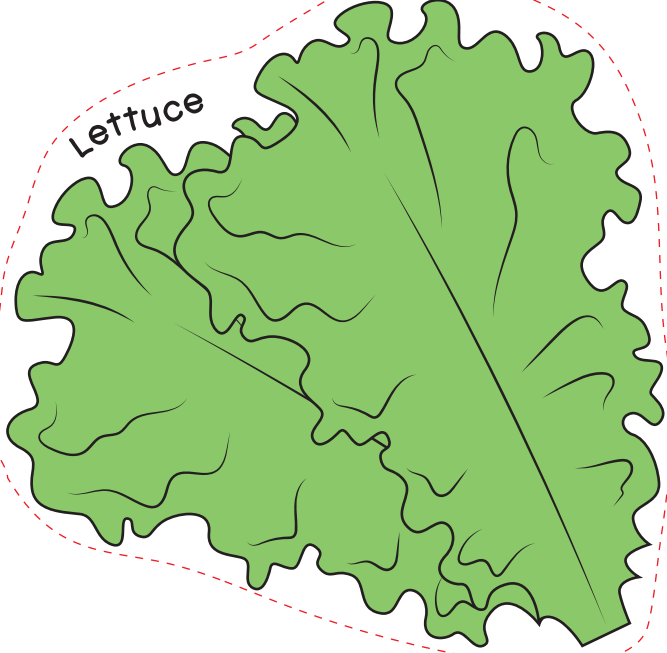

Bacon

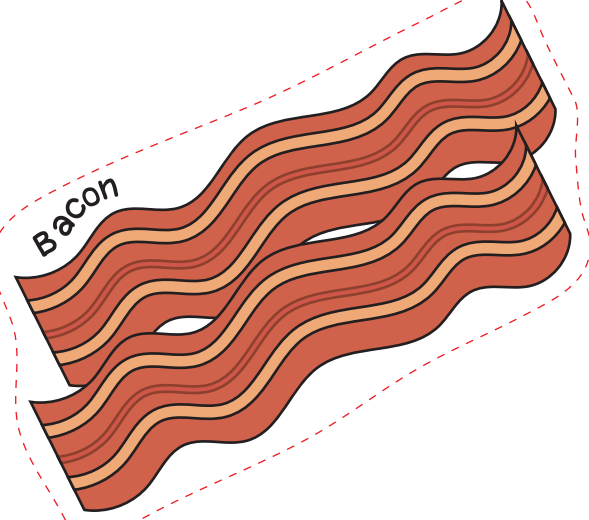

Tomatoes

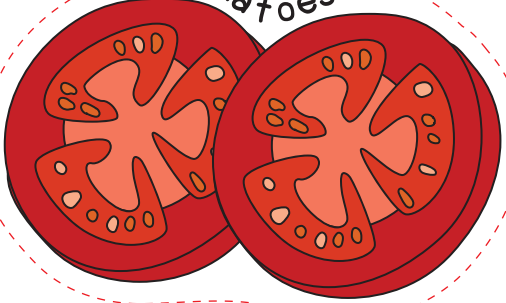

Mashed Potatoes

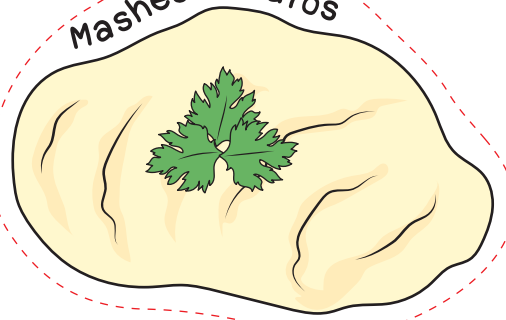

Sausage

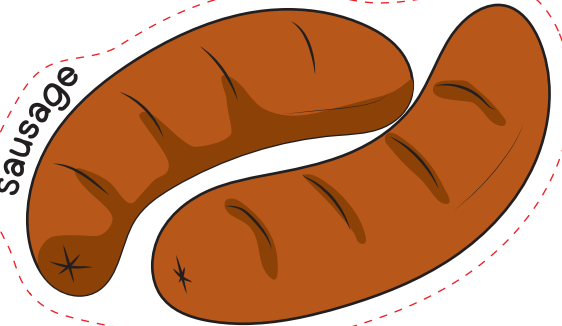

Lemons

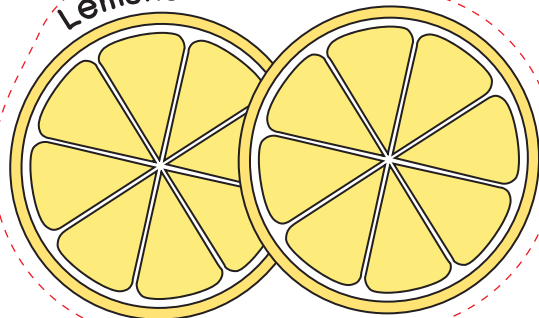

Asparagus

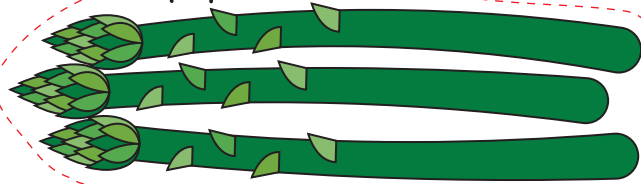

# Steak Order

1. Grilled beef steak with french fries.
2. Salmon with asparagus and lemon cream sauce.
3. Pork with mashed potatoes.
4. Grilled chicken and bacon with black pepper sauce.
5. Grilled beef steak with sausage mixed grilled vegetables.
6. Pork steak with french fries and salad.
7. Grilled salmon steak with fresh vegetables.
8. Lamb chops with mashed potatoes.



# Match the meat to the animal

จับคู่คำศัพท์

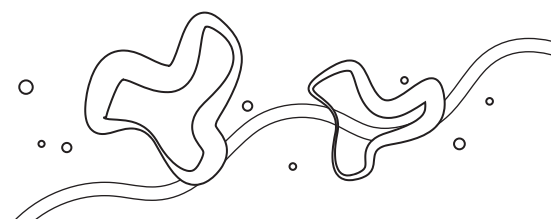
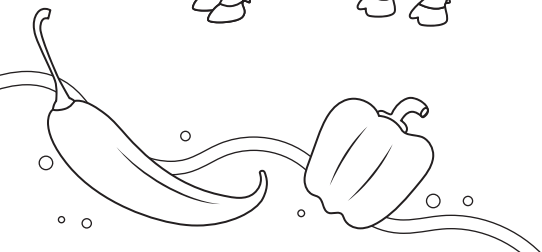
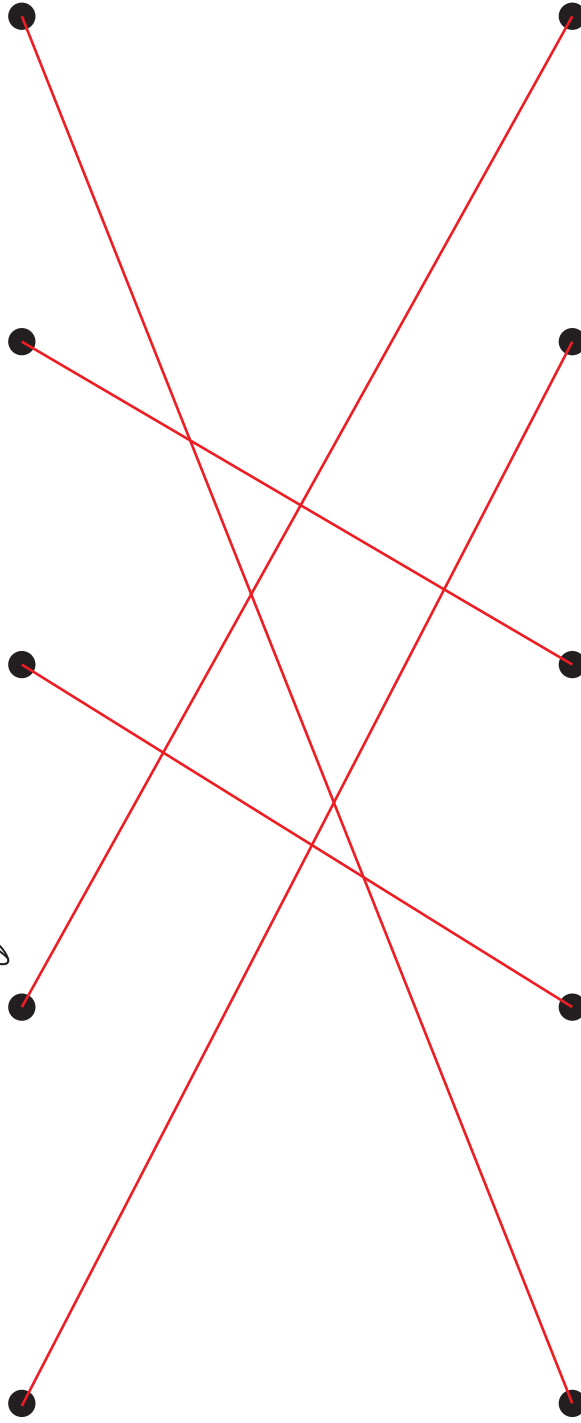
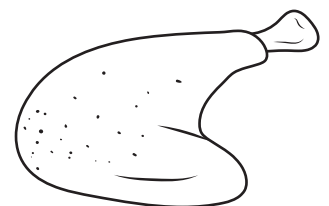
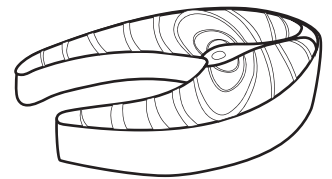
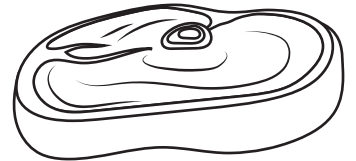
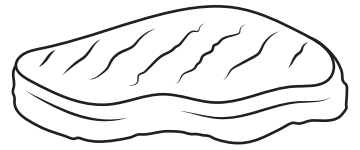
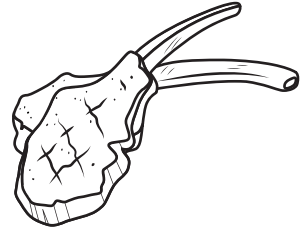
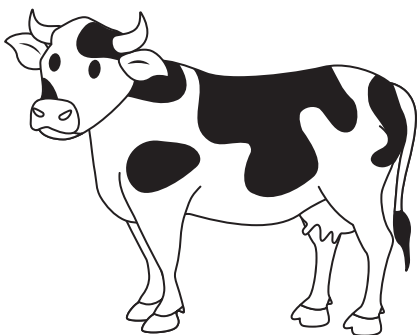
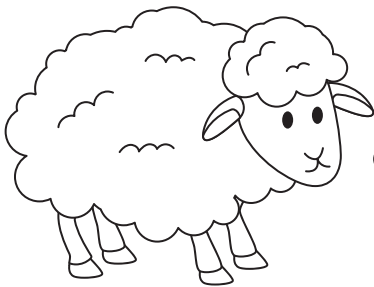
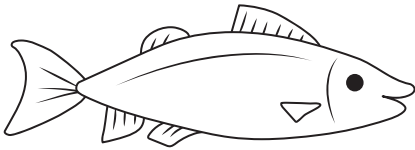
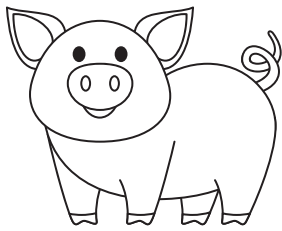
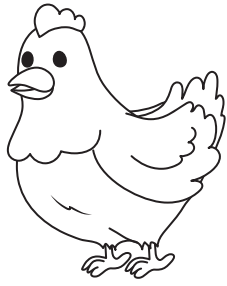

# Unscramble the words and make a sentence เขียนคำศัพท์ให้ถูกต้อง

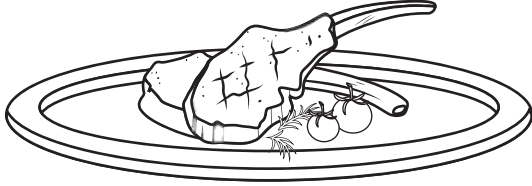

balm hpor

Lamb chop



kpor

Pork

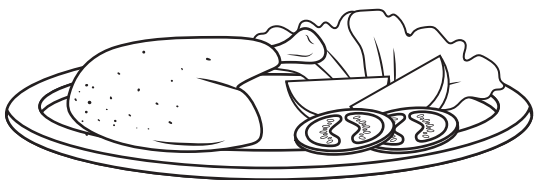

hkceichn

Chicken

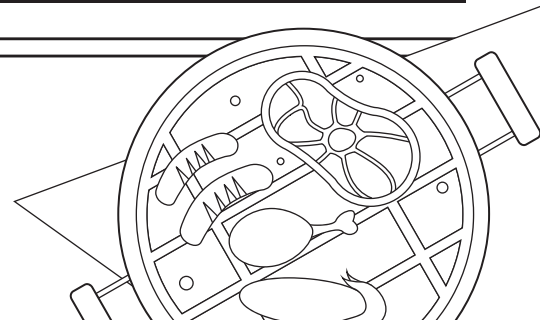
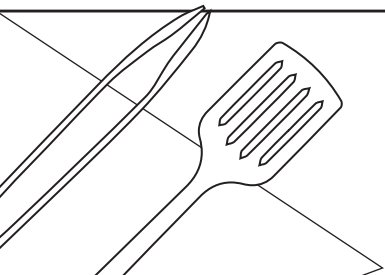

# Unscramble the words and make a sentence

เขียนคำศัพท์ให้ถูกต้อง

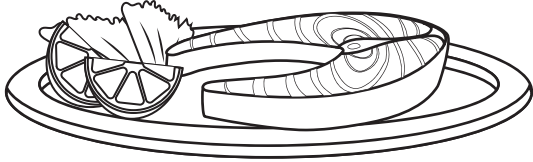

hsfi

**Fish**



fbee

**Beef**

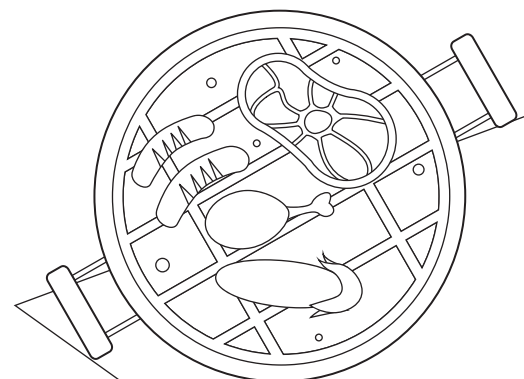
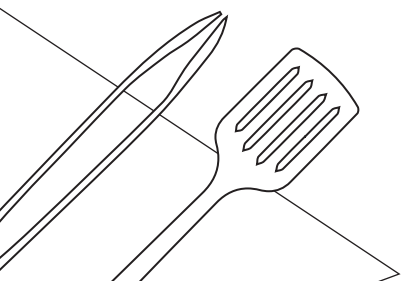

# Choose the correct answer

เลือกคำตอบให้ถูกต้อง

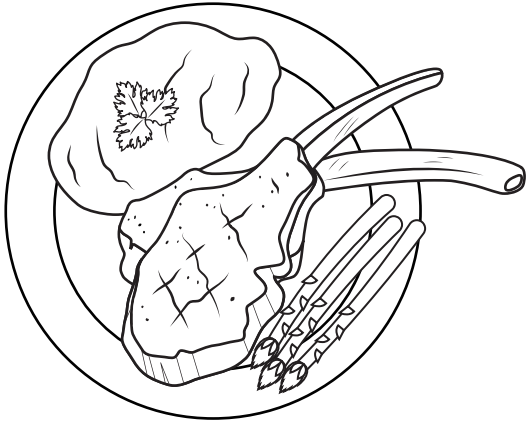

- Lamb chops with mashed potatoes and asparagus.
- Lamb chops with french fries and bacon.



- Grilled pork with a fresh vegetable salad.
- Grilled pork with french fries and tomato sauce.



- Chicken steak with lemon and lettuce.
- Chicken steak with corn.

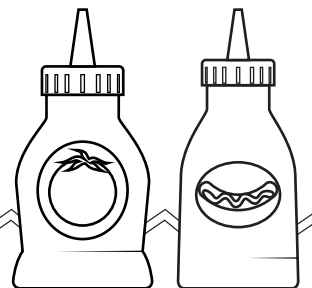

# Choose the correct answer

เลือกคำตอบให้ถูกต้อง

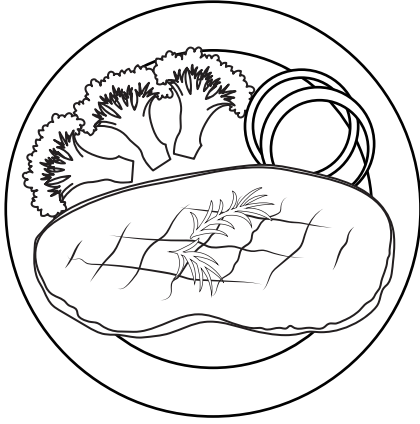

- Grilled beef steak and colorful peppers.
- Beef steak with broccoli and onions.



- Salmon with spinach and beans.
- Salmon with mushroom sauce and lemon.

