

ทากาว

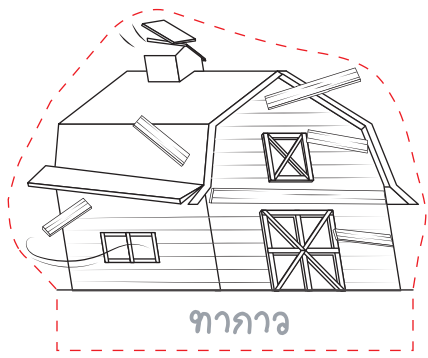

ทากาว

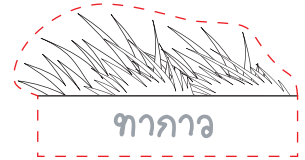

ทากาว



ทากาว

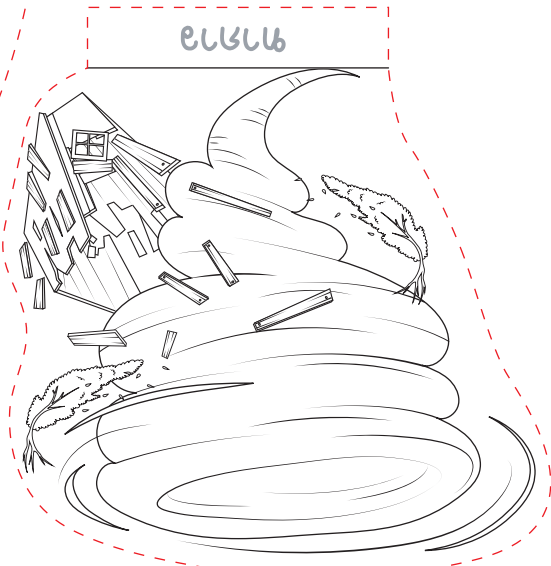

ทากาว

Tornado

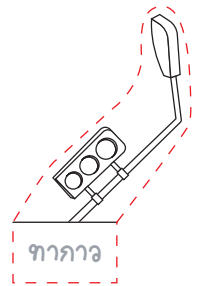
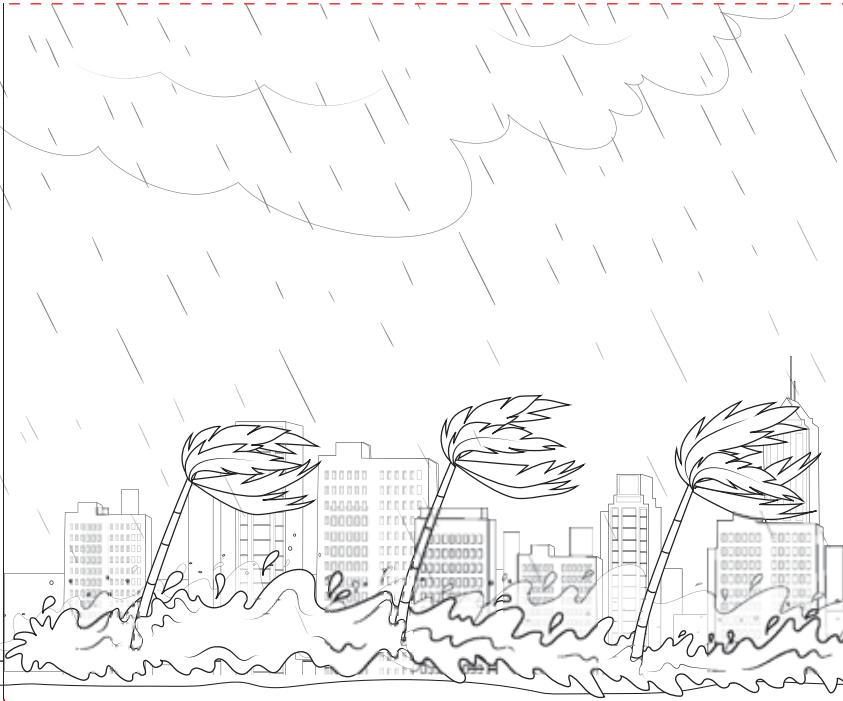

ຫາກາວ

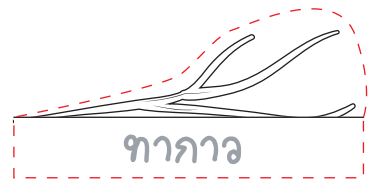

ຫາກາວ



ຫາກາວ

ຫາກາວ

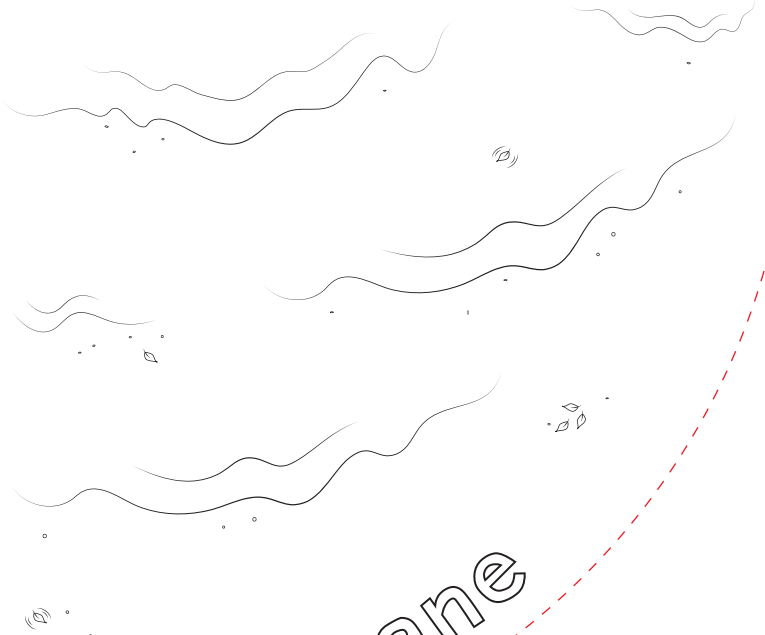

Hurricane

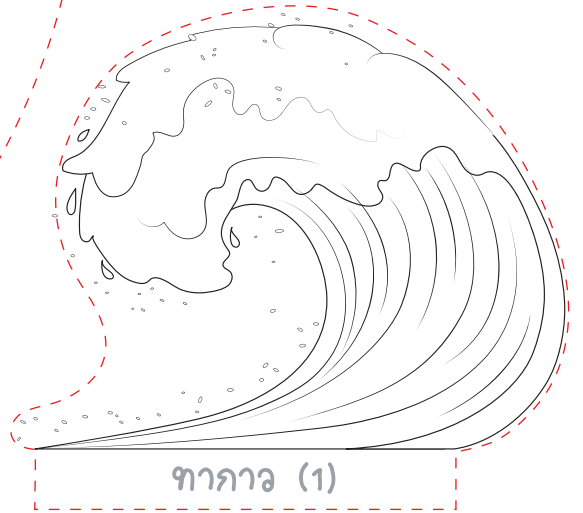
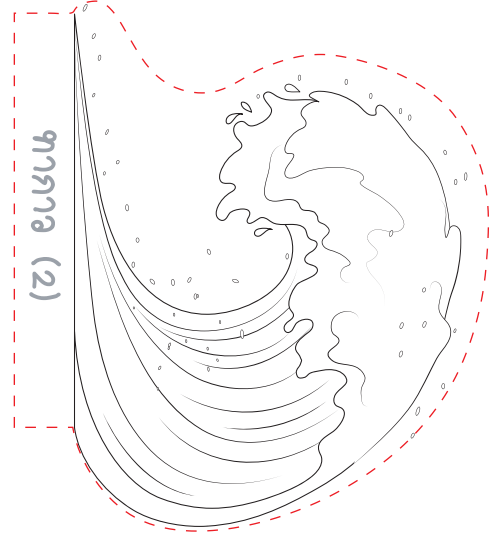
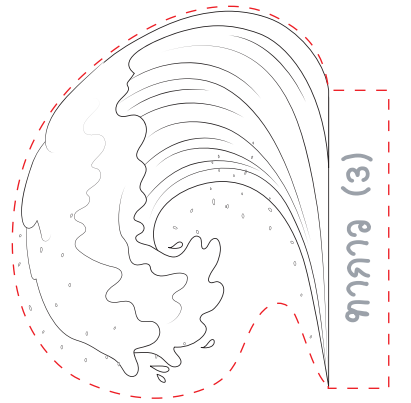
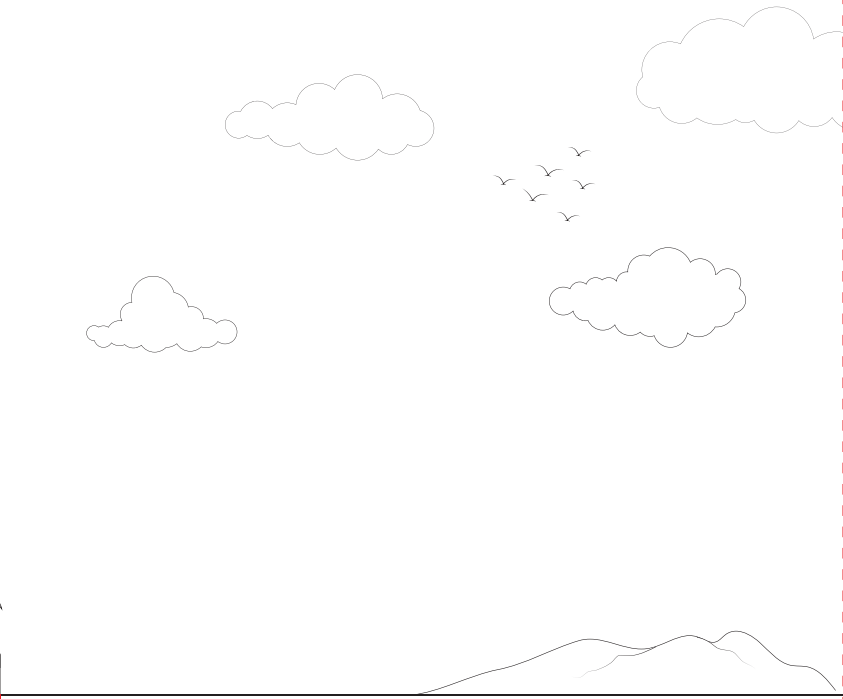

ทากาว

Tsunami

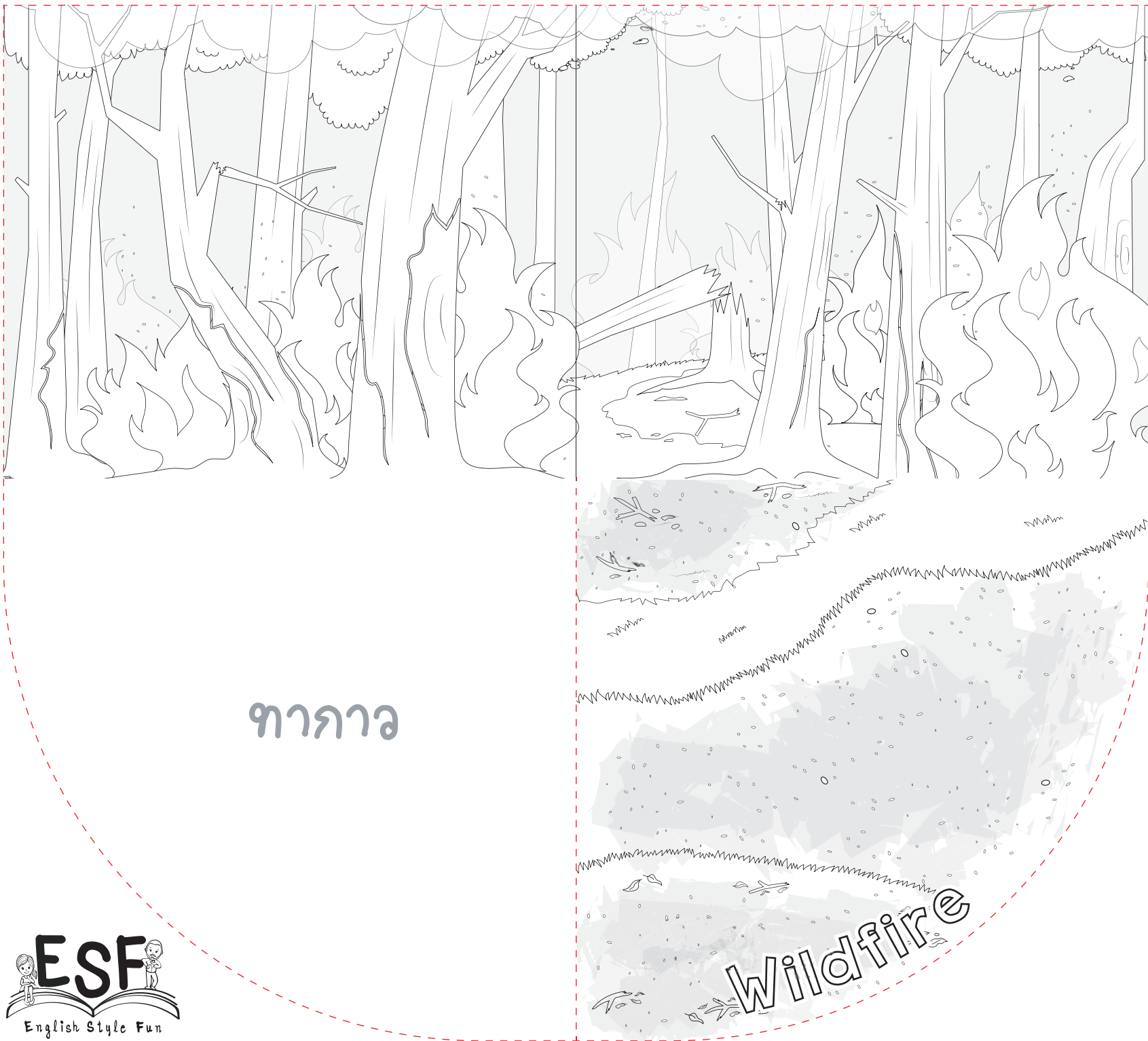

ကားကား

Wildfire

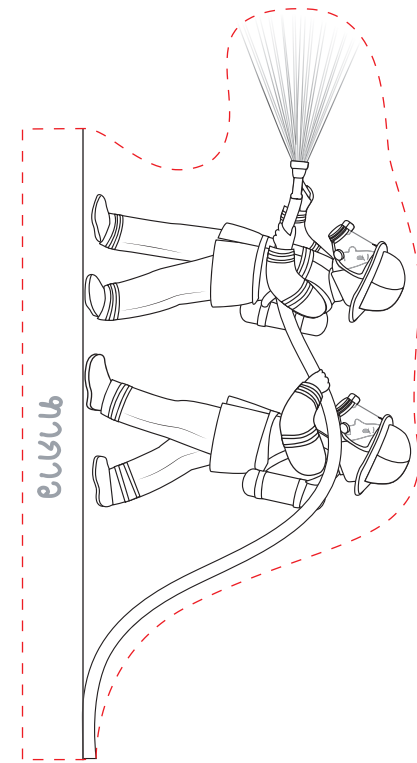

ကားကား

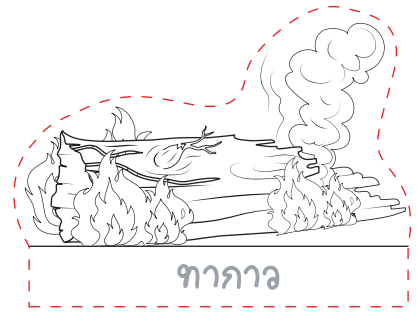

ကားကား

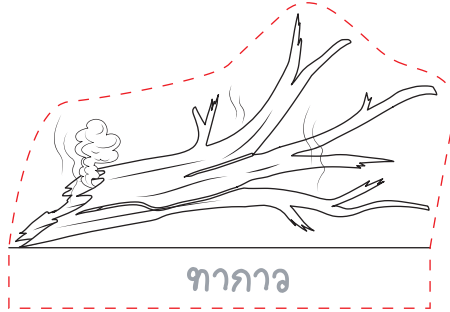

ကားကား

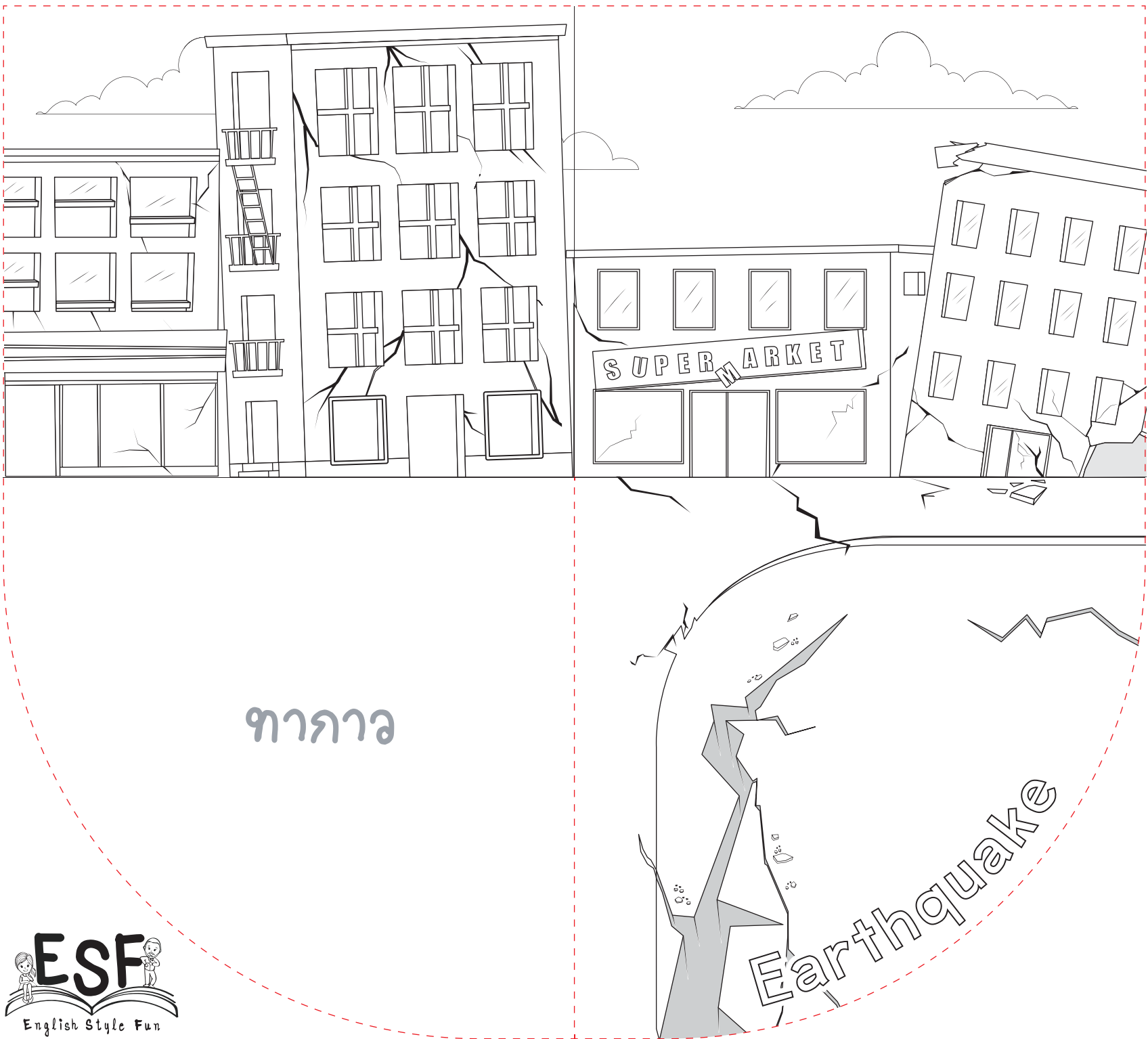

ทากาว



ทากาว



ทากาว

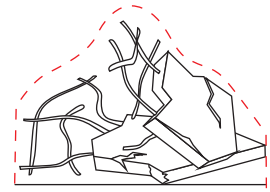

ทากาว

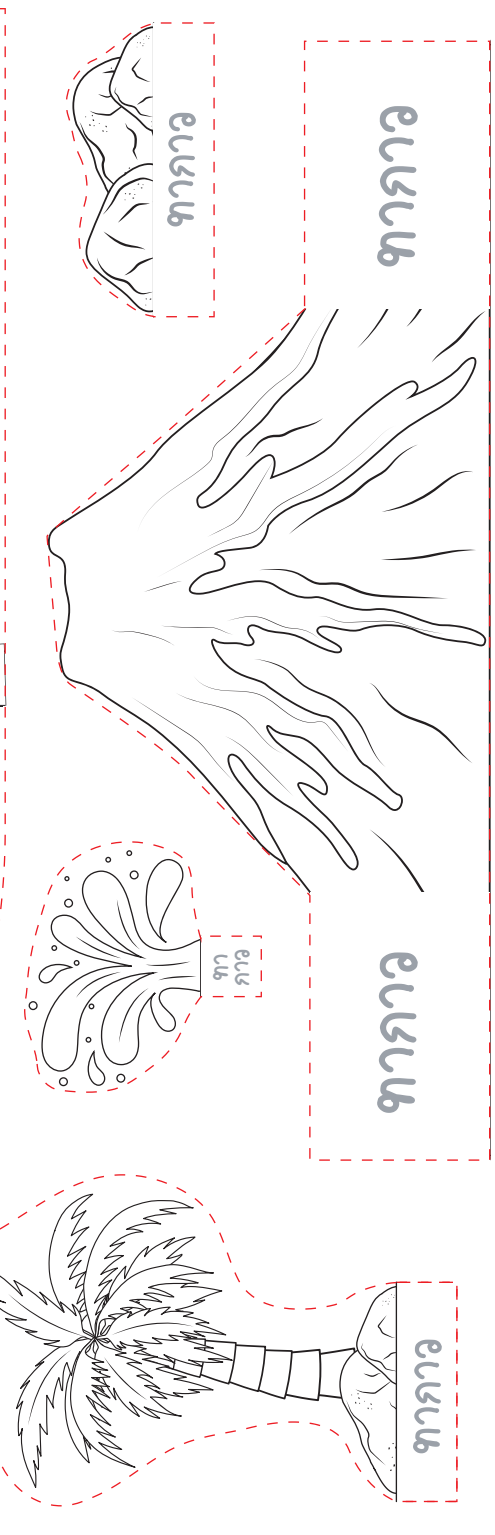
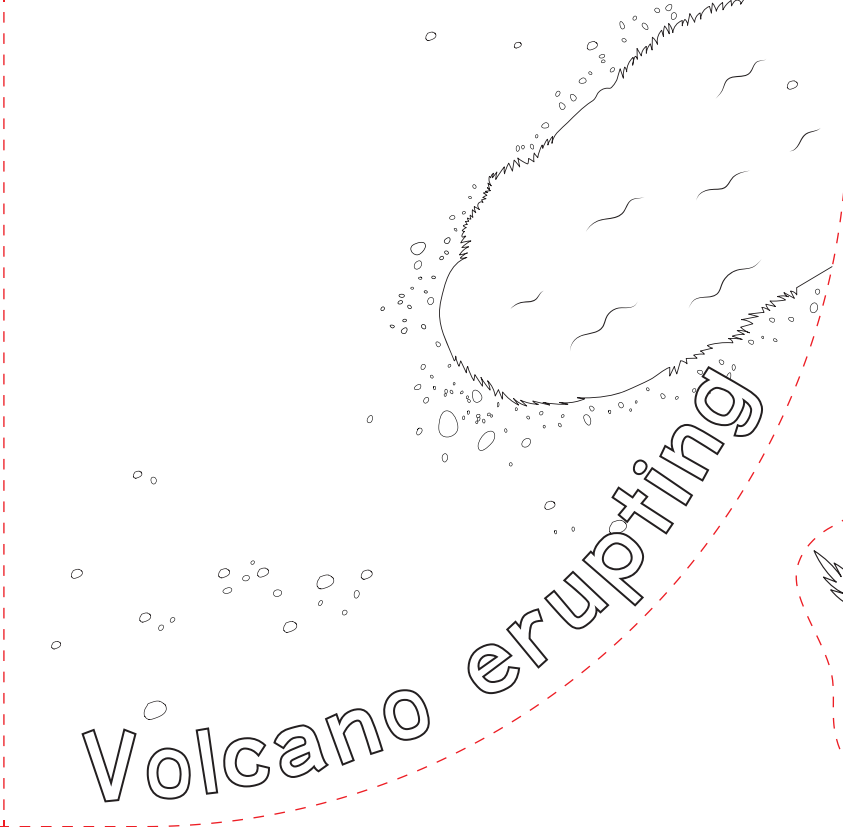
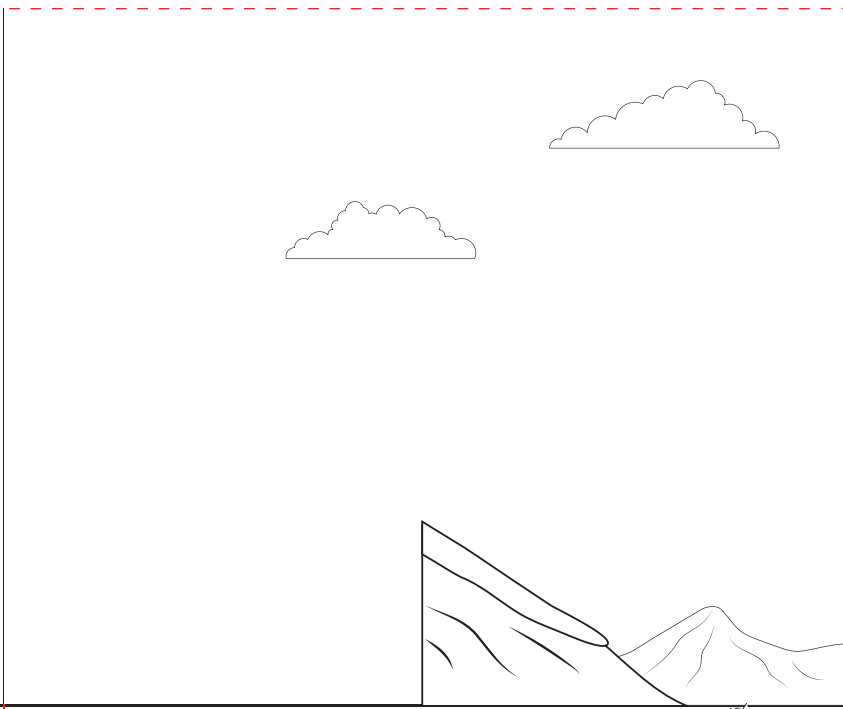
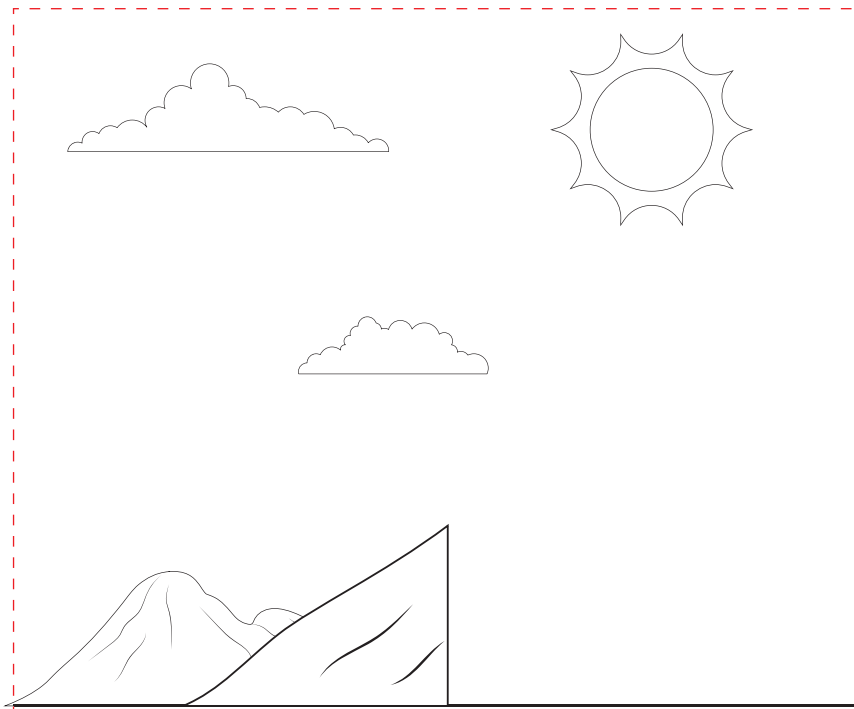



ຫາກາວ



ຫາກາວ



ຫາກາວ

ຫາກາວ

Landslides

ຫາກາວ

ຫາກາວ

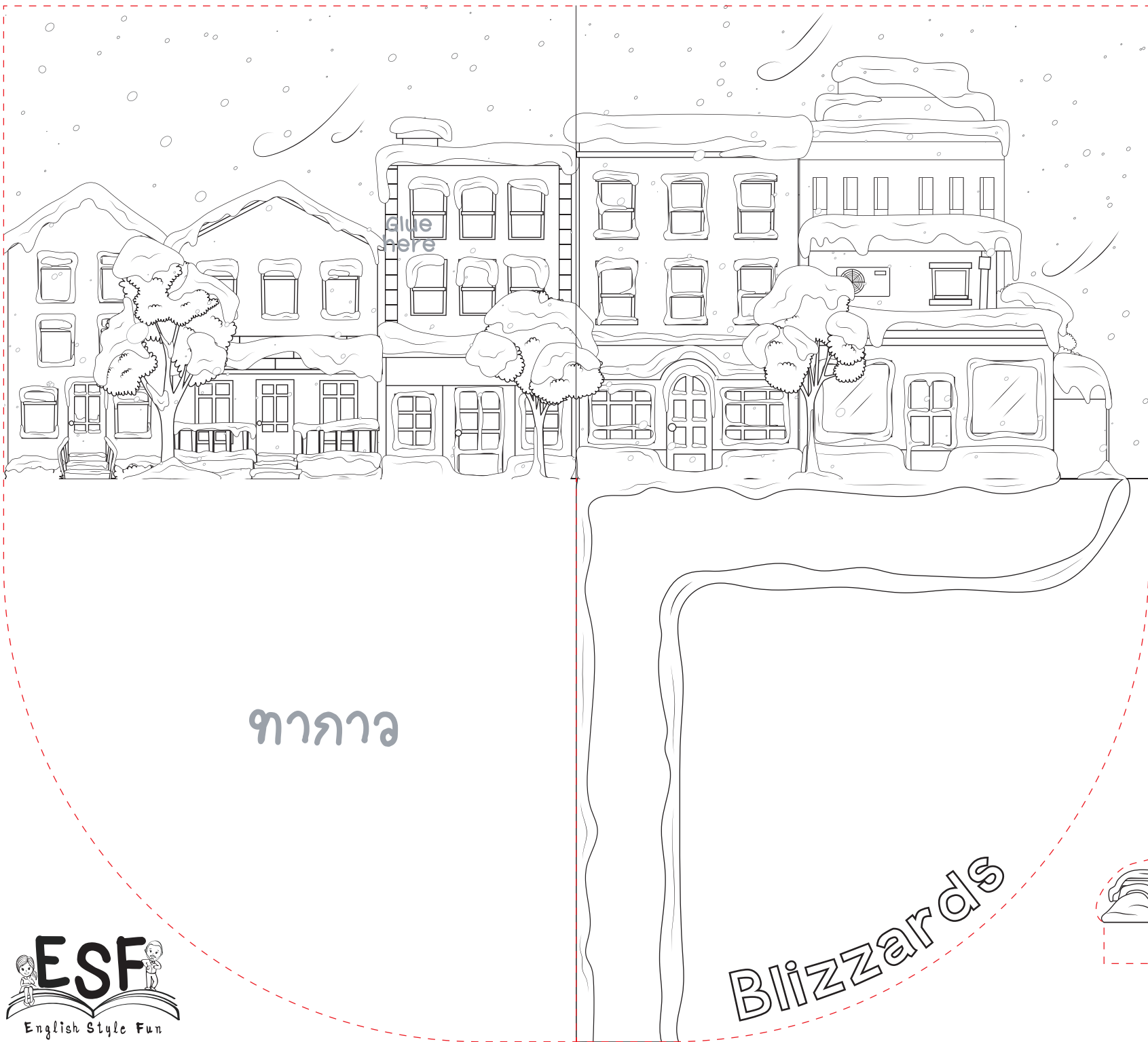

Glue here

พายุหิมะ

Blizzards



พายุหิมะ



พายุหิมะ

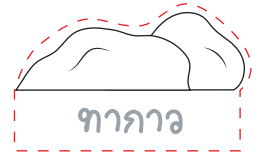

พายุหิมะ

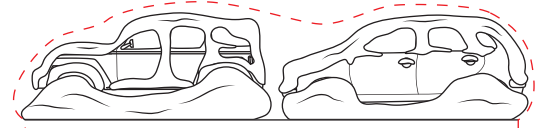

พายุหิมะ



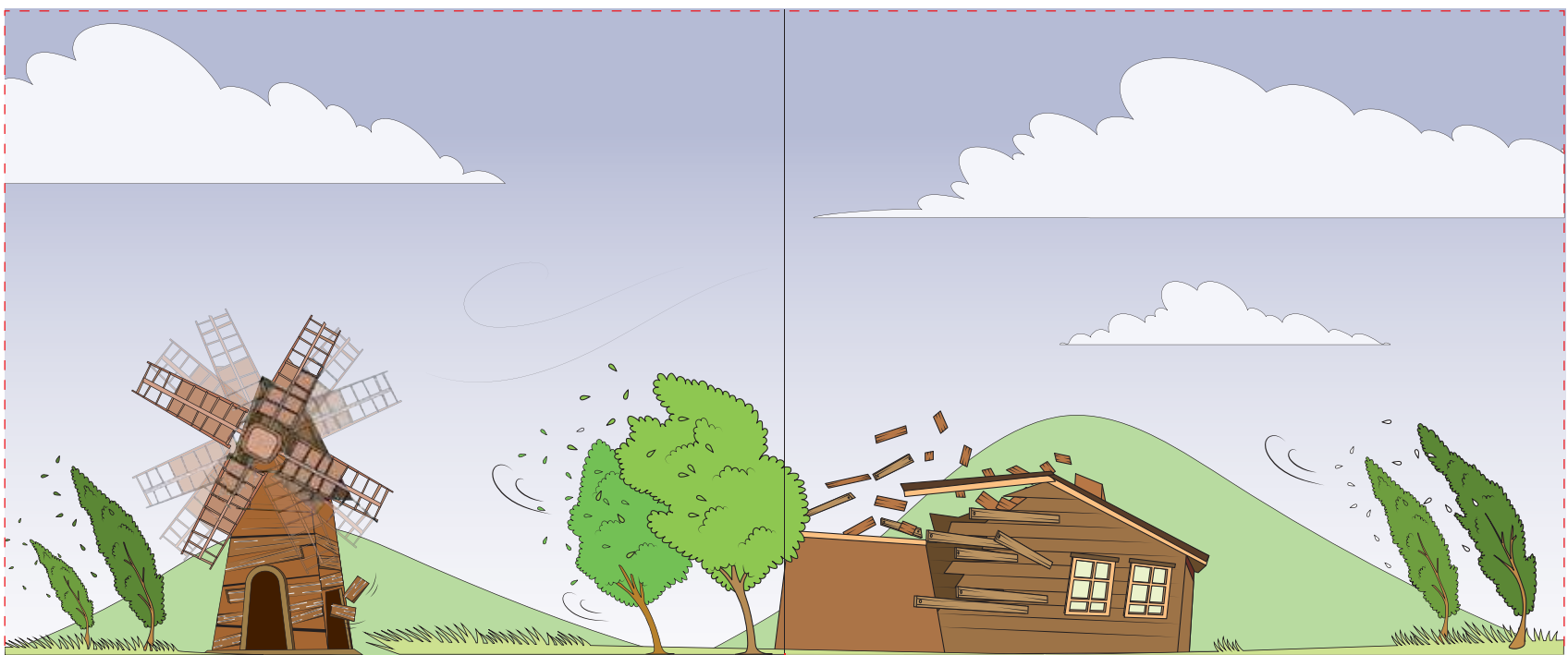

தாகა



Tornado

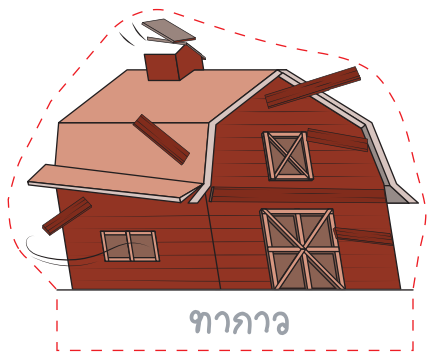

தாகა

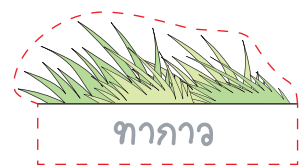

தாகა



தாகა

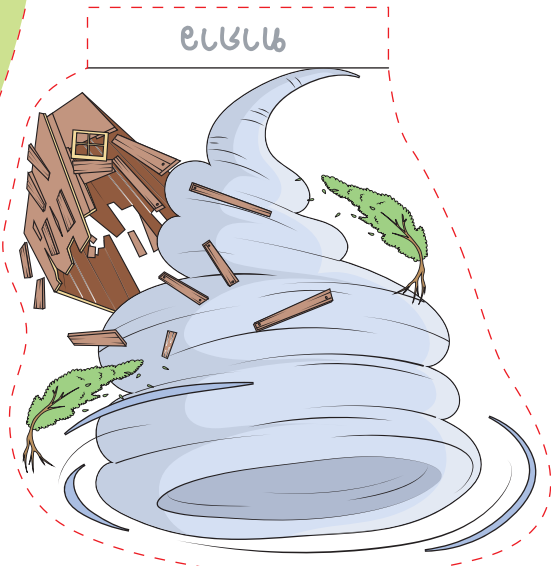

ტარაკი

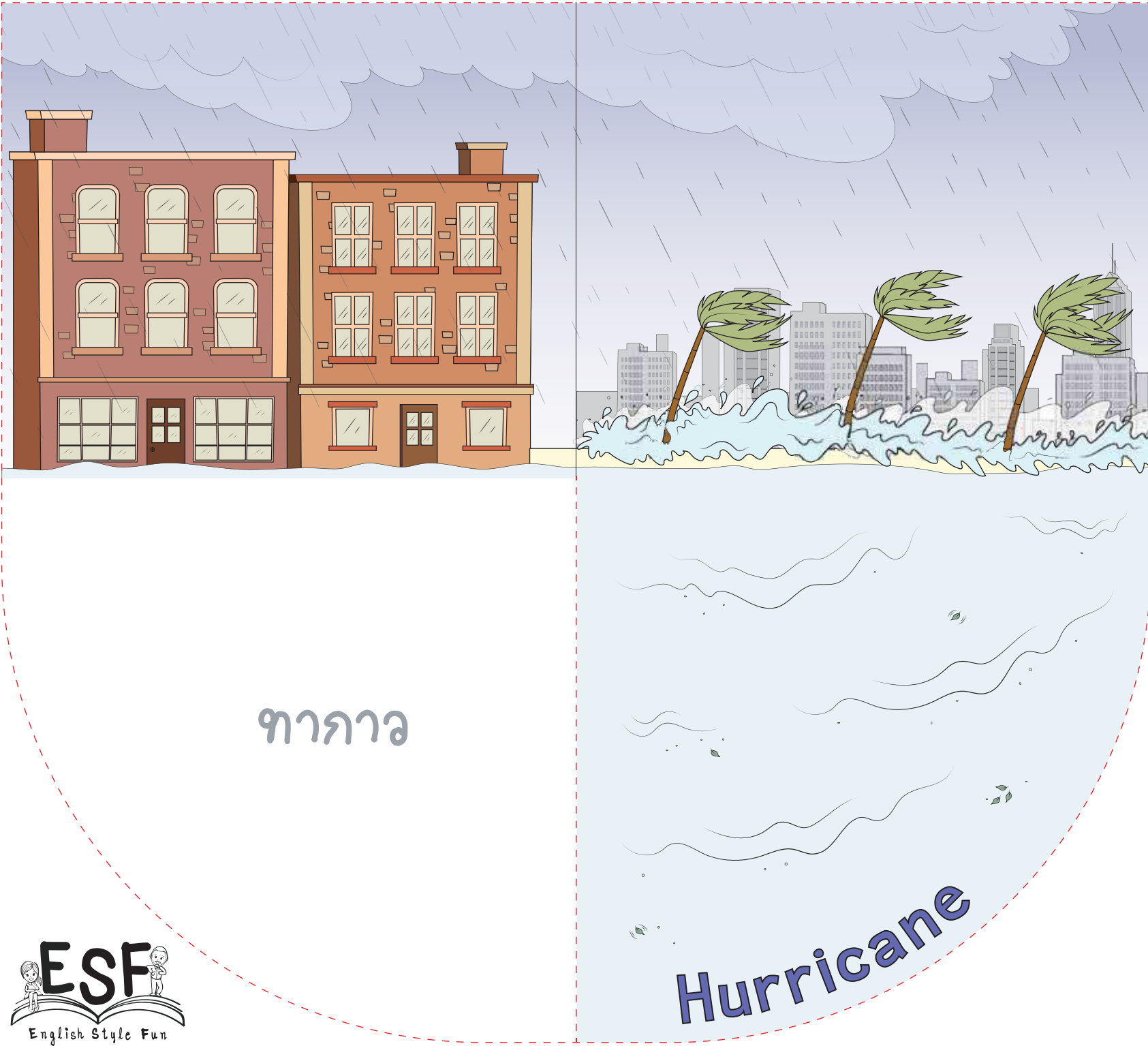

พายุ

Hurricane

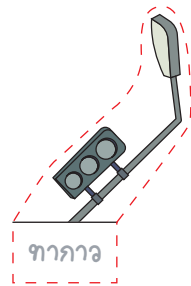

พายุ

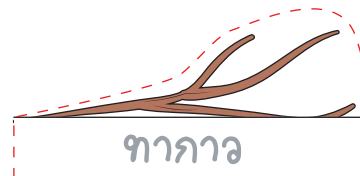

พายุ

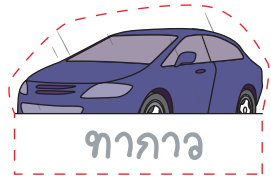

พายุ

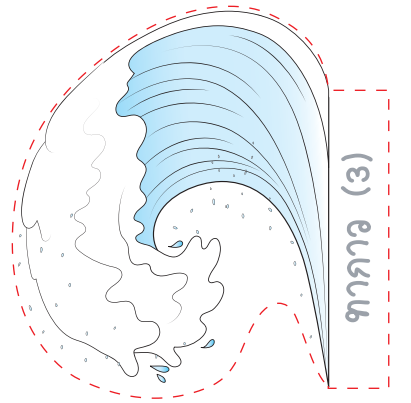
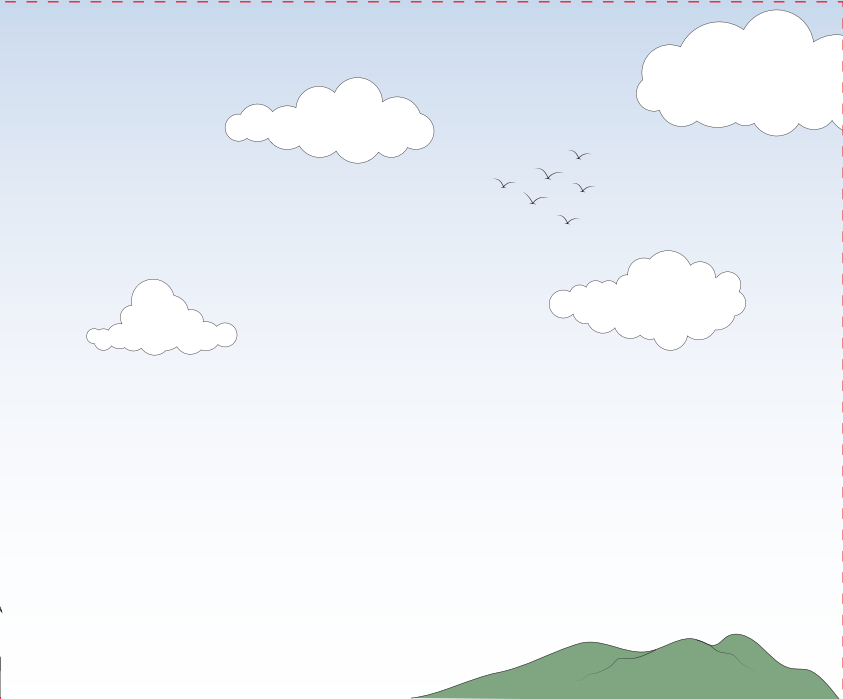

ທາກາວ (3)

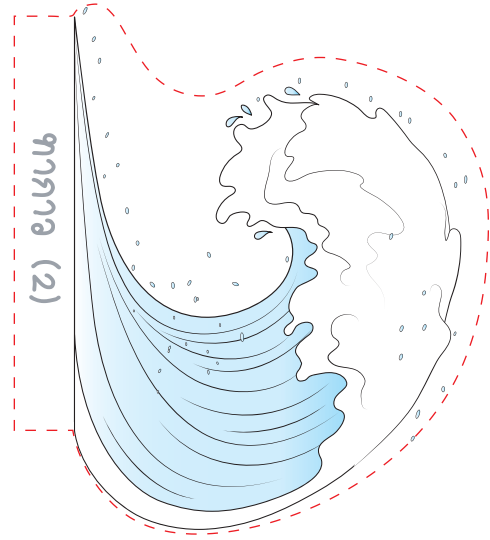

ທາກາວ (2)

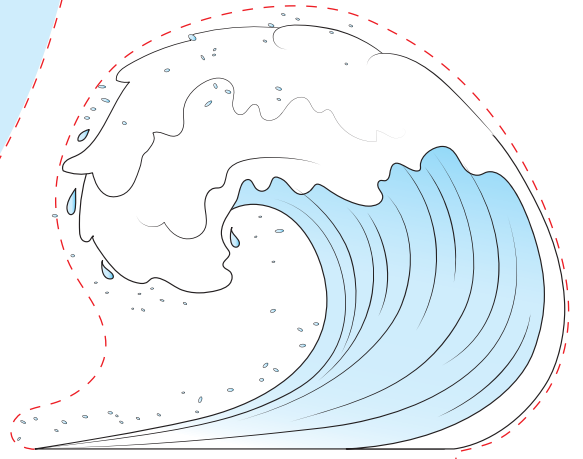

ທາກາວ (1)

ທາກາວ

Tsunami



ကားကား



Wildfire

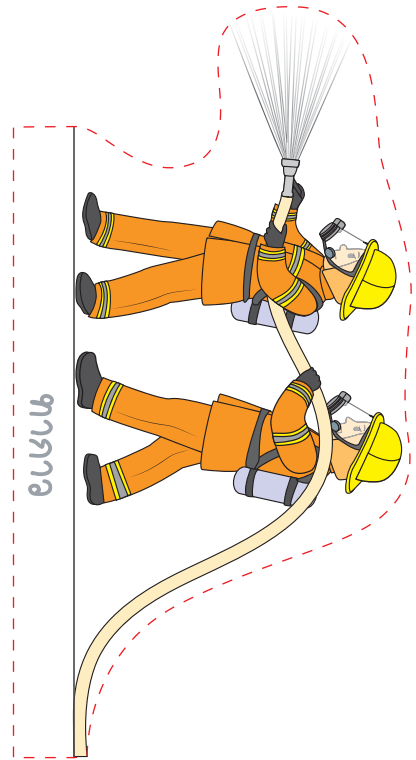

ကားကား



ကားကား



ကားကား

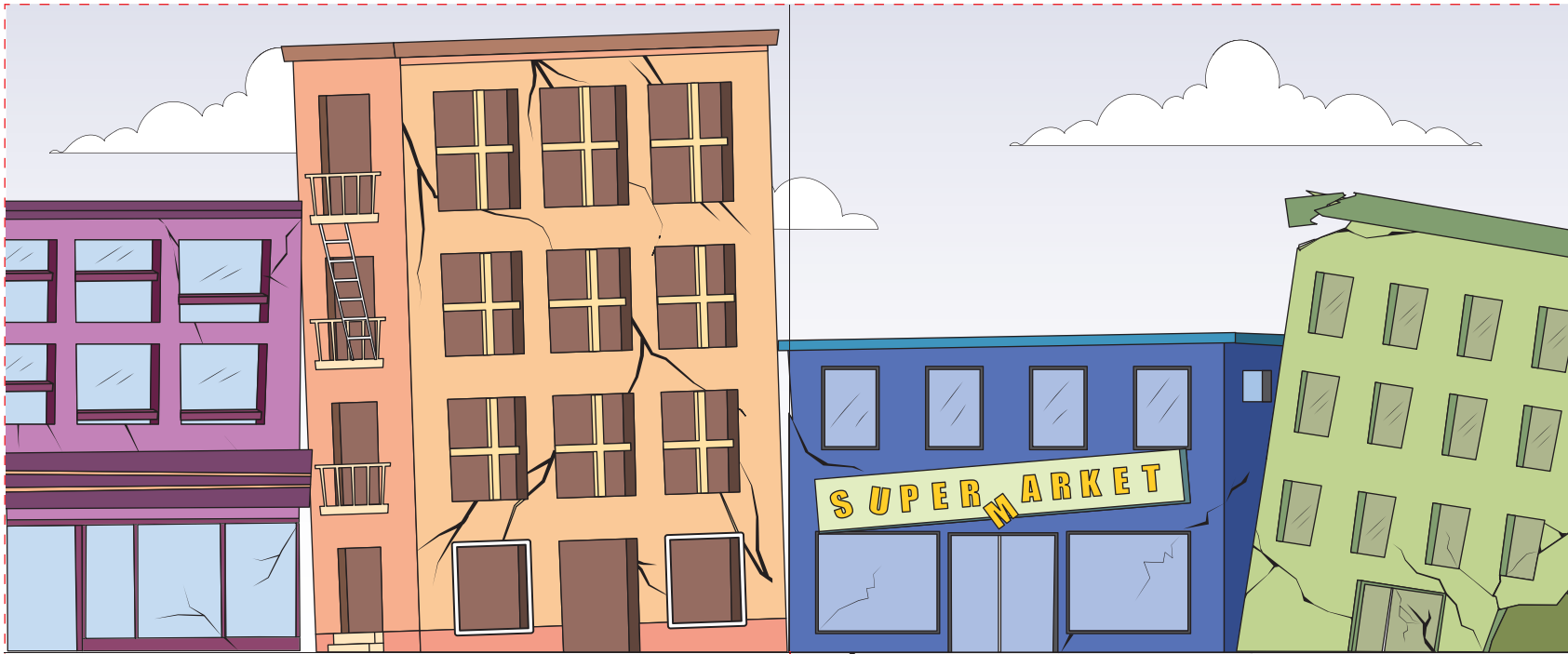

ทากาว

Earthquake



ทากาว



ทากาว

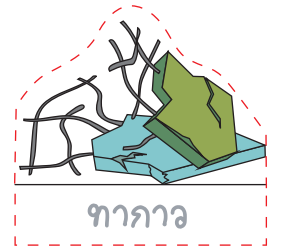

ทากาว

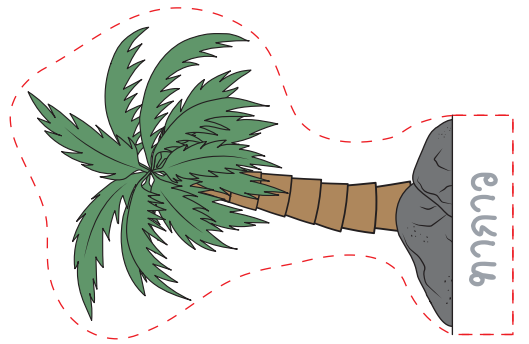
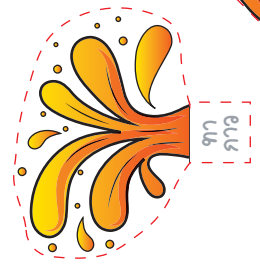
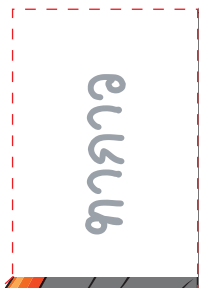
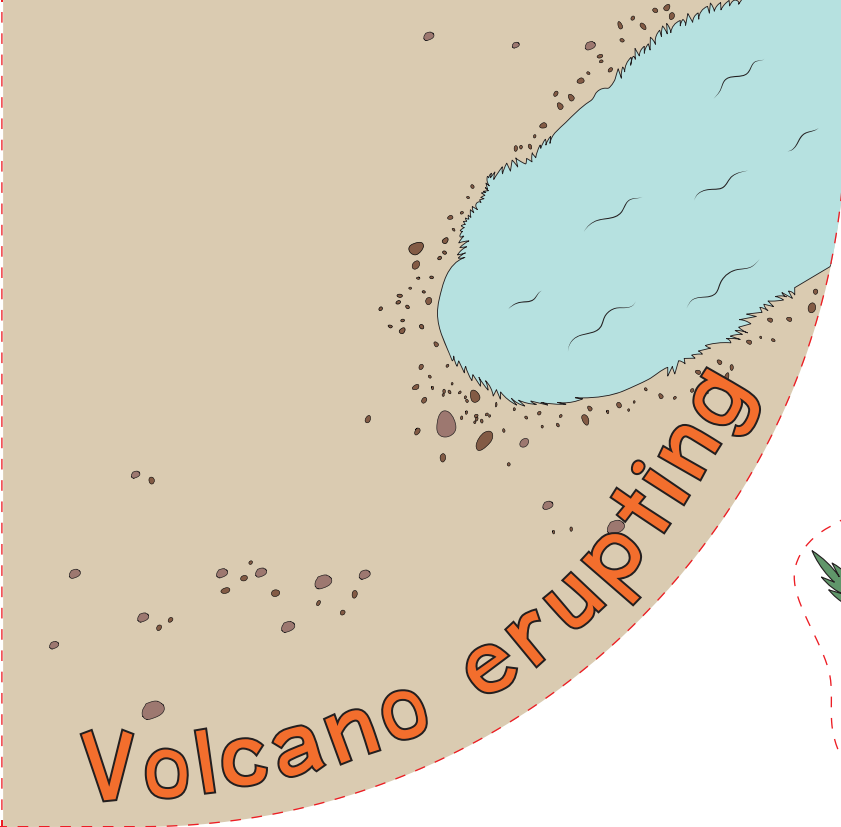
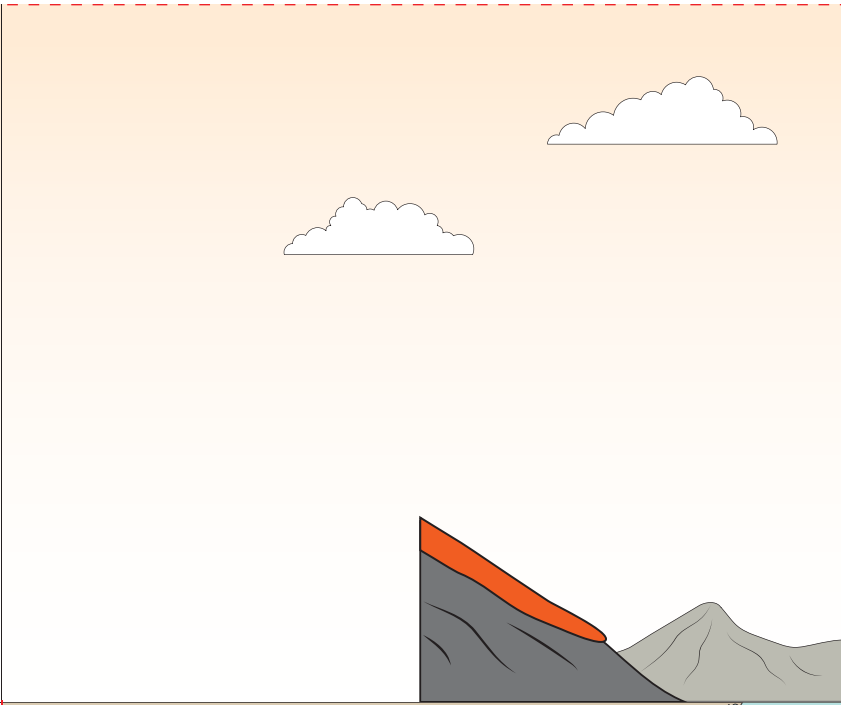
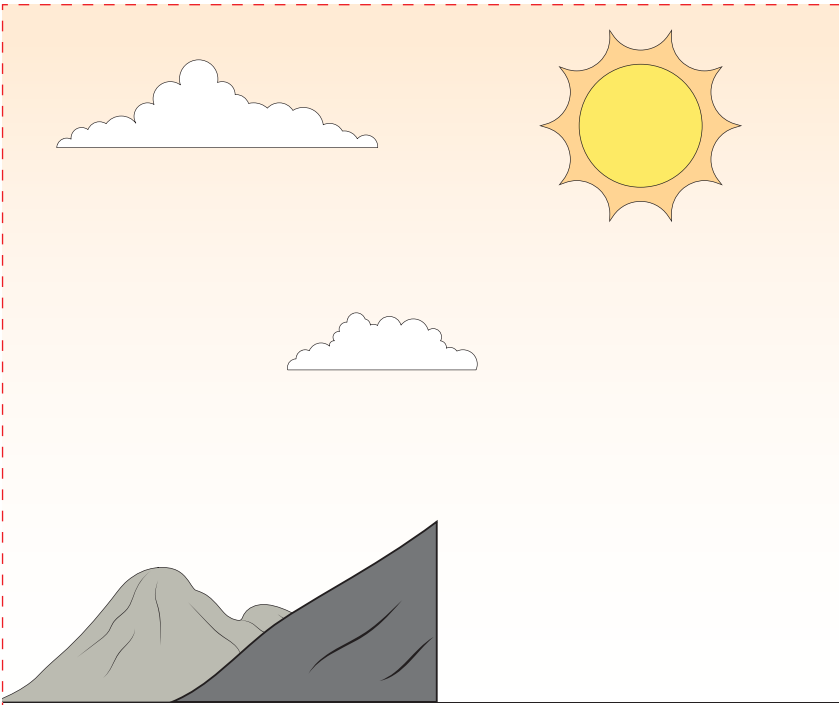

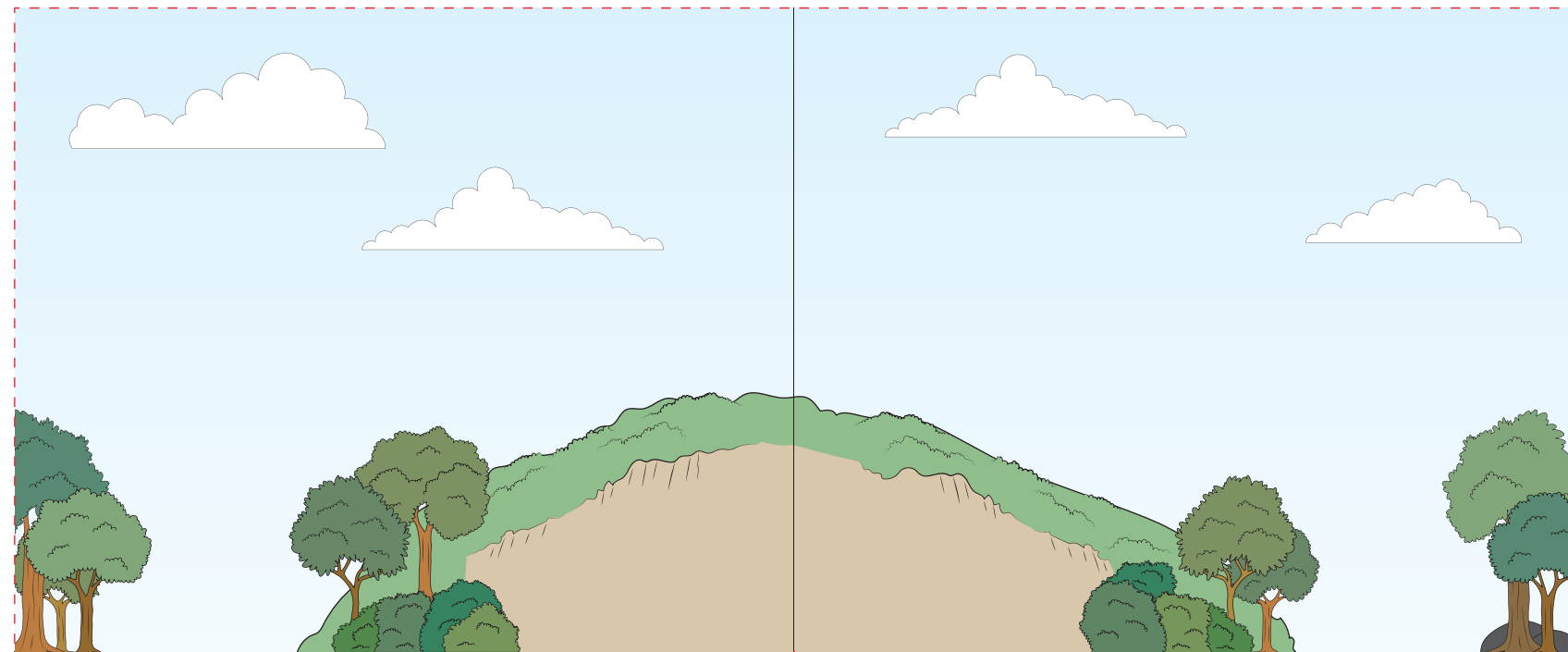

ຫາກາວ

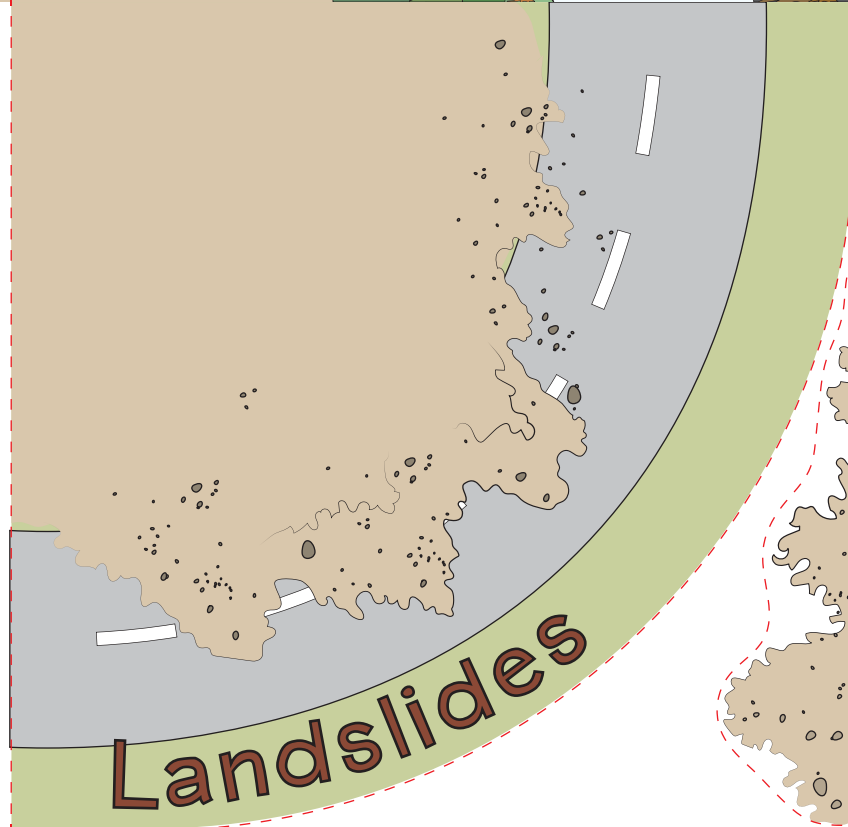

Landslides

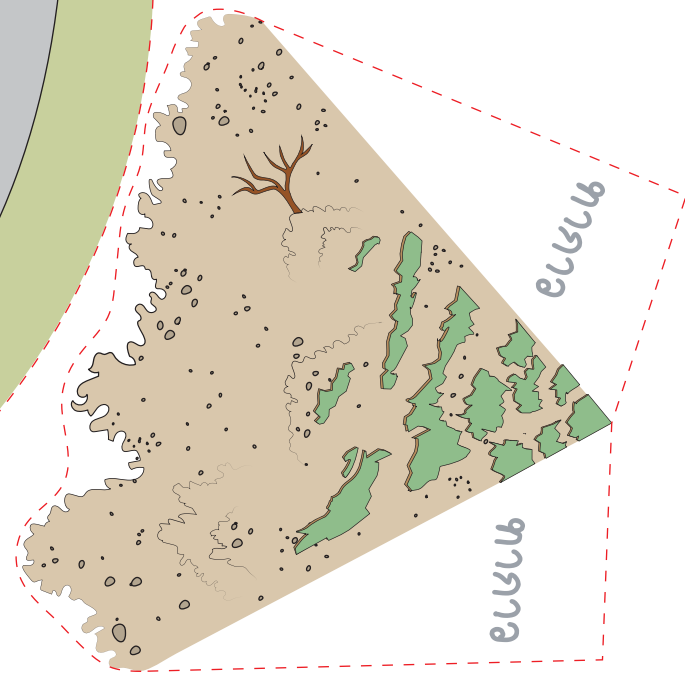

ຫາກາວ

ຫາກາວ

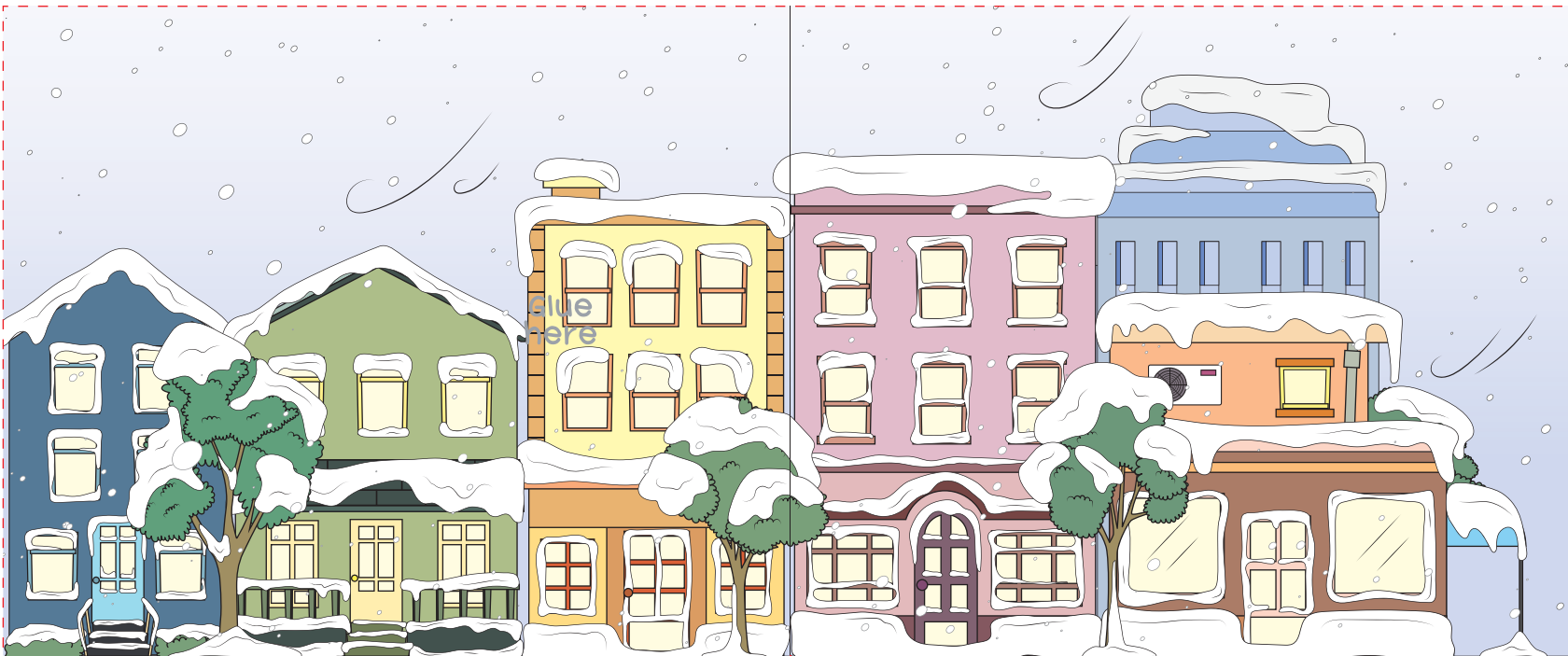

หิมะ



หิมะ



หิมะ



หิมะ

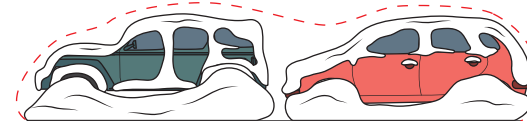

หิมะ

Blizzards