

Pirate hat

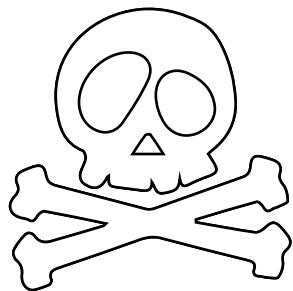

ຫາກາວຕຽງ

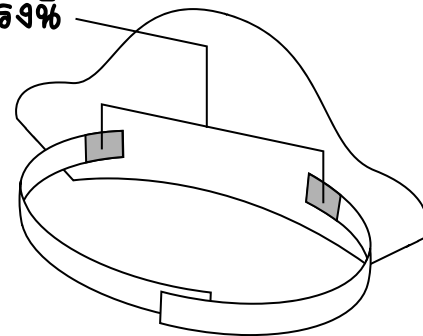

ຫາກາວ

ຫາກາວ

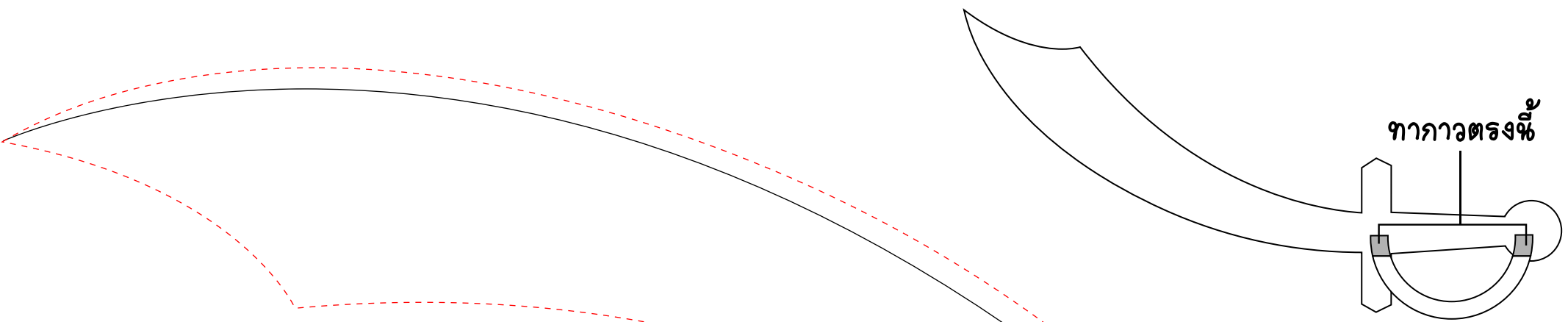

ຫາກວດຮຽນ

Sword

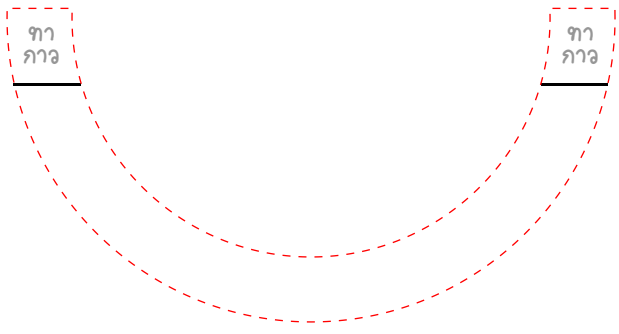

ຫາ
ກວ

ຫາ
ກວ

Pirate eye patch

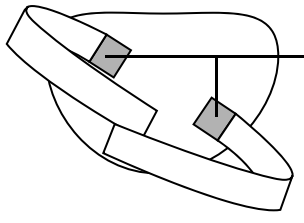

ຫາກວດຮຽນ



Two horizontal dashed red lines forming a rectangular box. The top line contains the Thai word 'ຫາກວ' (Ka-ka) on the left side. The bottom line contains the Thai word 'ຫາກວ' (Ka-ka) on the left side. The space between the lines is empty, intended for writing practice.

Mast

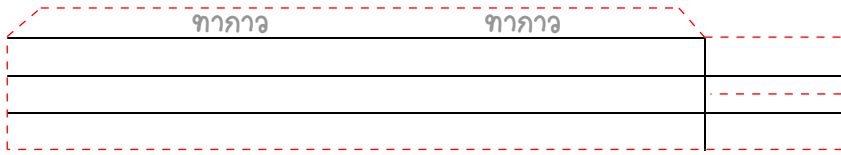

ทากาวด้านล่าง
เพื่อติดกับเรือ

Ship

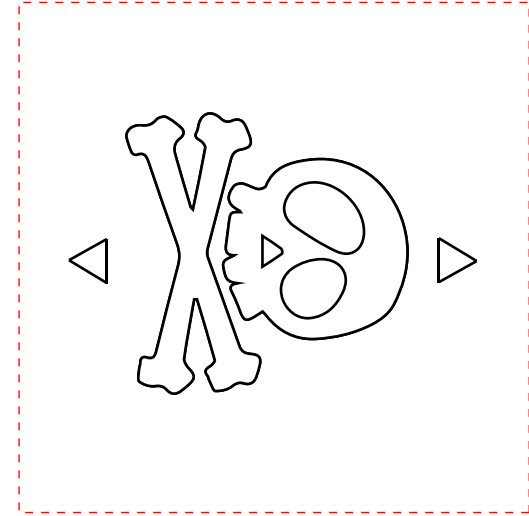
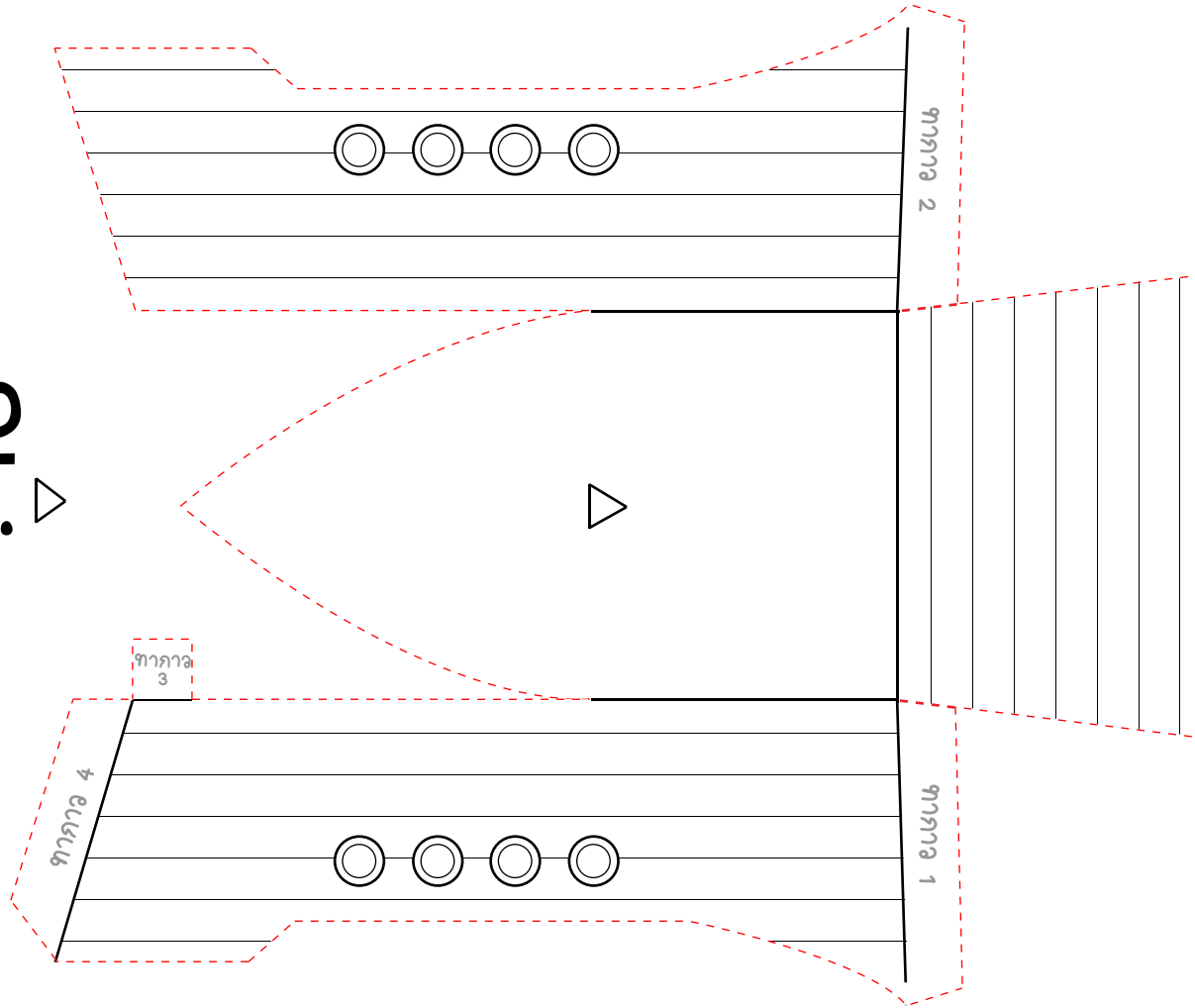

Flag

◀ คำศัพท์ ▶

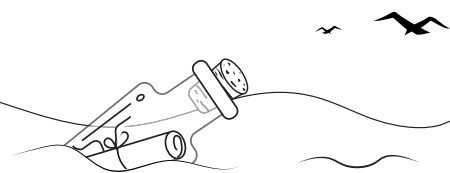
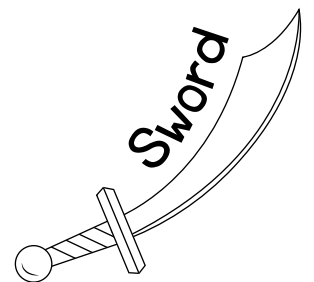
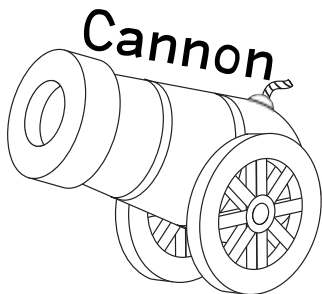
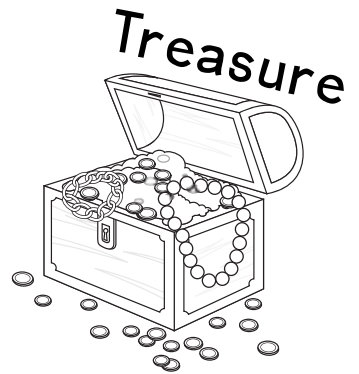
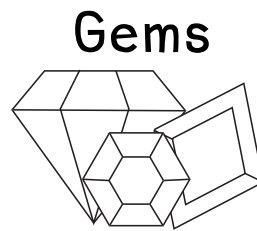
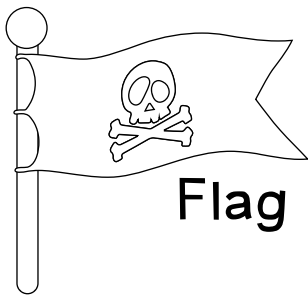
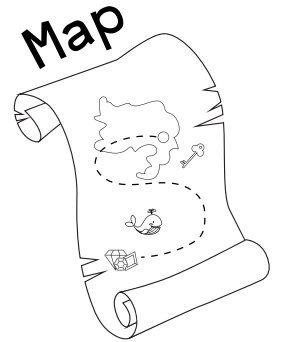
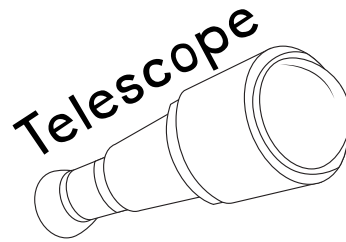
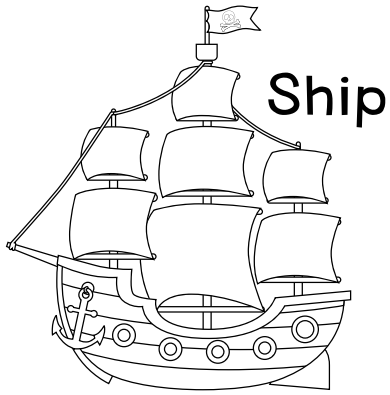

Write the correct answer เติมคำตอบให้ถูกต้อง

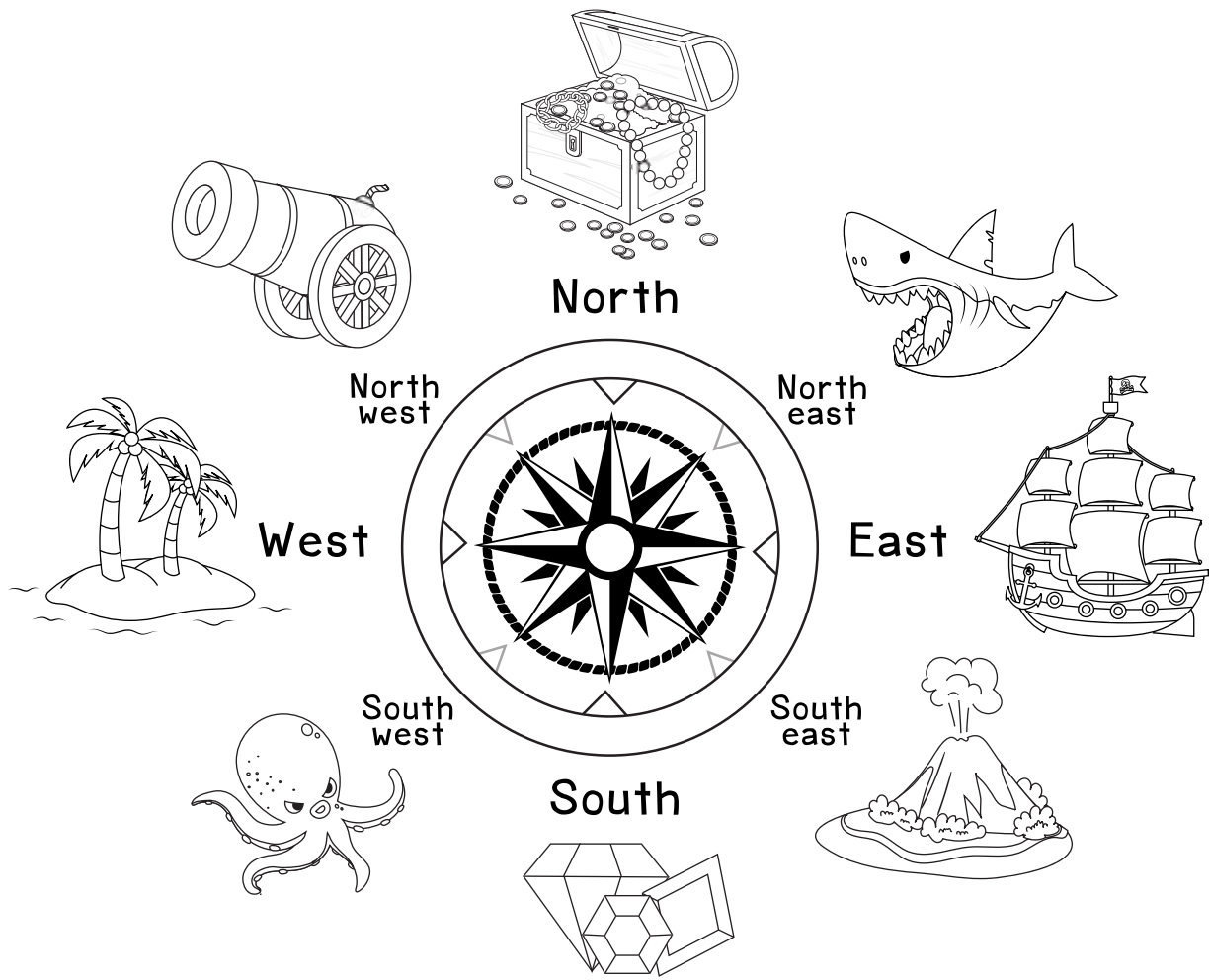

Is the pirate ship to the west or to the East? _____

What direction should you sail to reach the island? _____

If you don't like sharks, which direction should you avoid? _____

Will you find the gems to the south or to the west? _____

Will you find treasure to the north or to the southeast? _____

What is the direction of the volcano? _____

Will you find the cannon to the northwest or to the south? _____

Where does the octopus live? _____



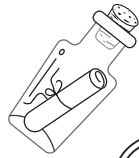
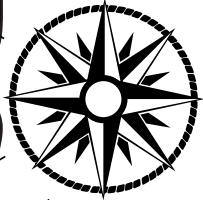

2

1



Start

3

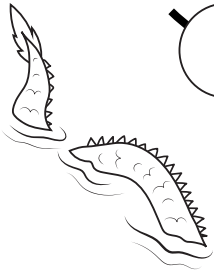
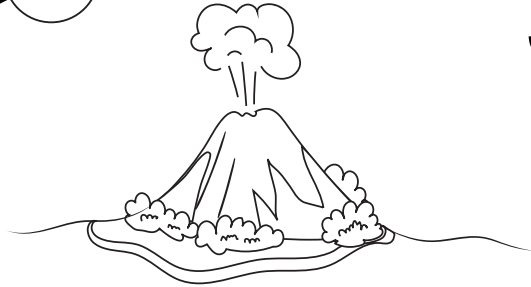

4



Move ahead 2 spaces!

5



6

Go back to start!

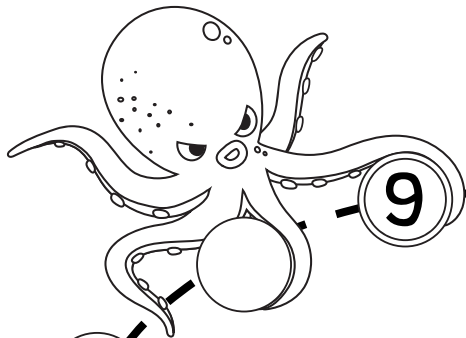

9

8



7

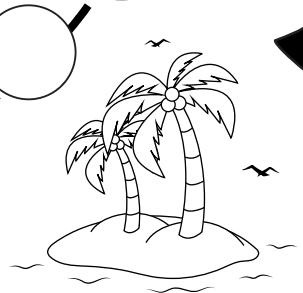

10

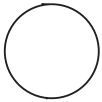

11

Miss a turn!

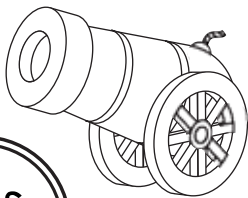

12



Finish

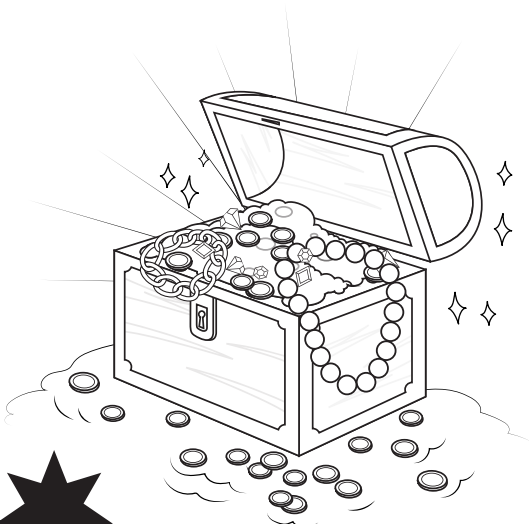

Board game

คำแนะนํ
เมื่อถึงคิวผู้เล่นหากเดินไปตกลงที่ช่องตัวเลข
ผู้เล่นจะต้องเติมคำศัพท์ลงบนใบงาน A

ลูกเต๋า

หมากเดิน

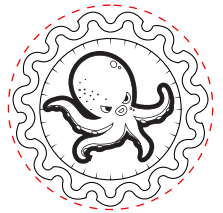
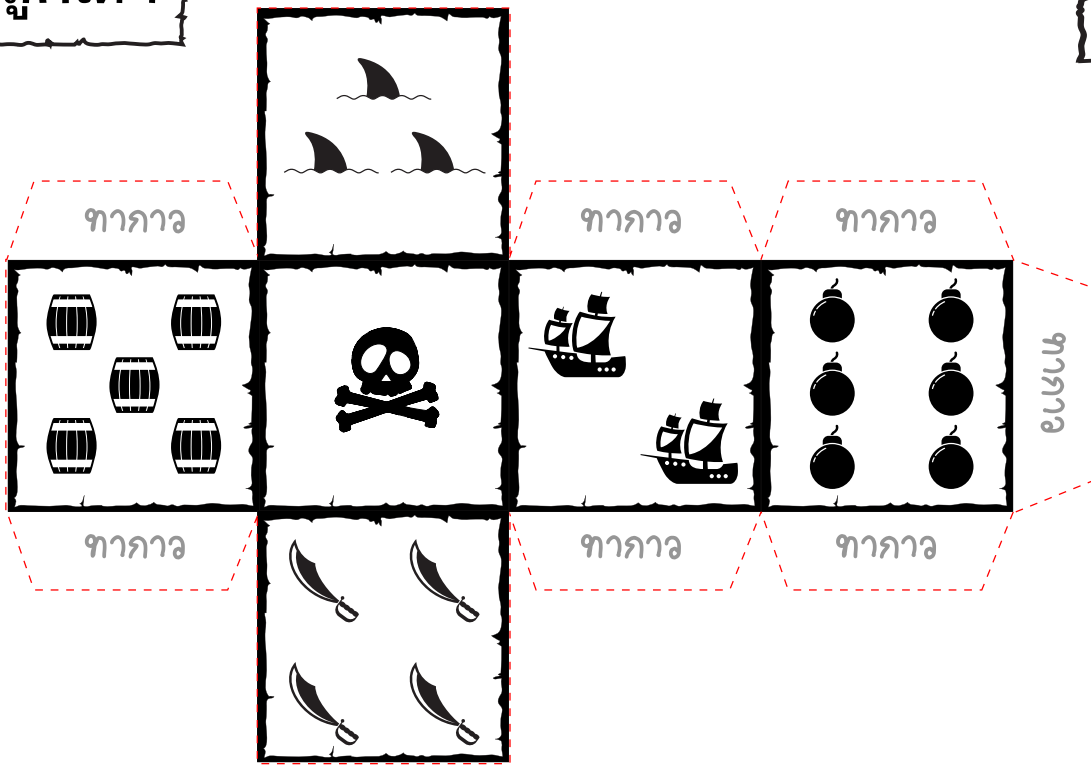

ใบงาน A

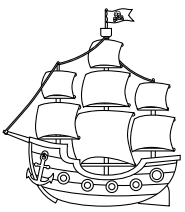

1. _____

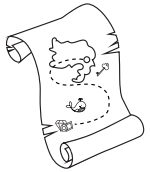

2. _____

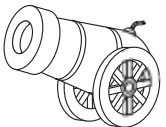

3. _____



4. _____



5. _____

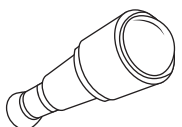

6. _____



7. _____



8. _____

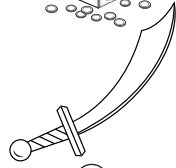

9. _____



10. _____

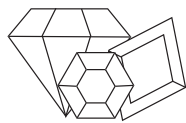

11. _____

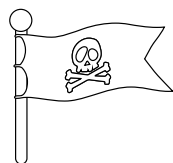

12. _____

Pirate hat

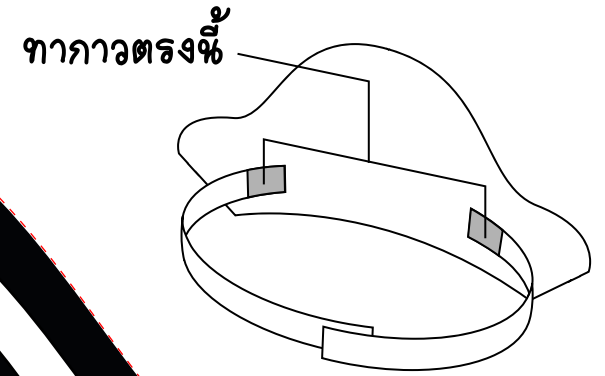

ຫາກາວ

ຫາກາວ

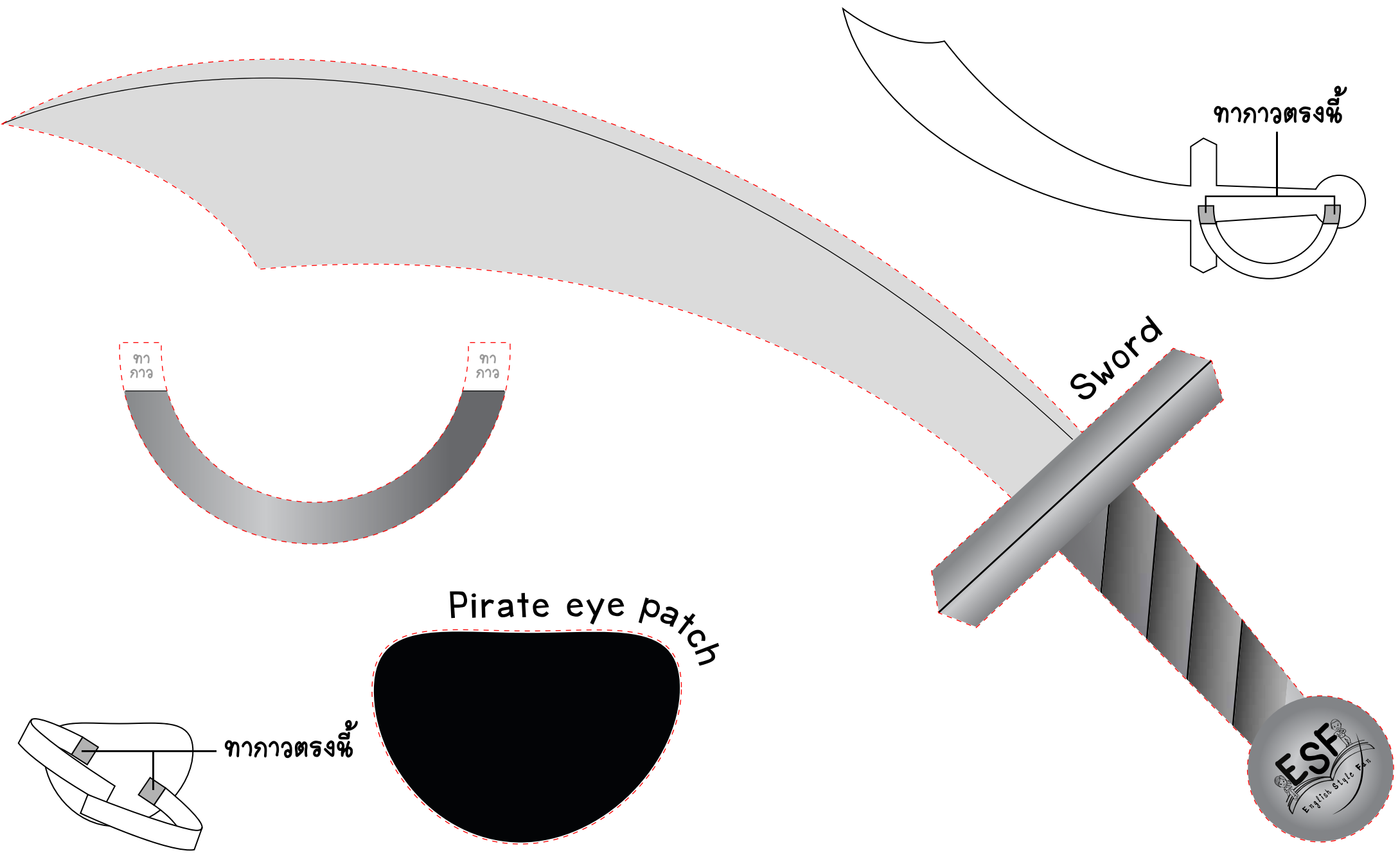

ຫາກາວຕຽງ

Sword

Pirate eye patch

ຫາກາວຕຽງ

ESF
English Style Fun

ຫາ
ກາວ

ຫາ
ກາວ

ຫາກາວ

ຫາກາວ



Mast



Ship

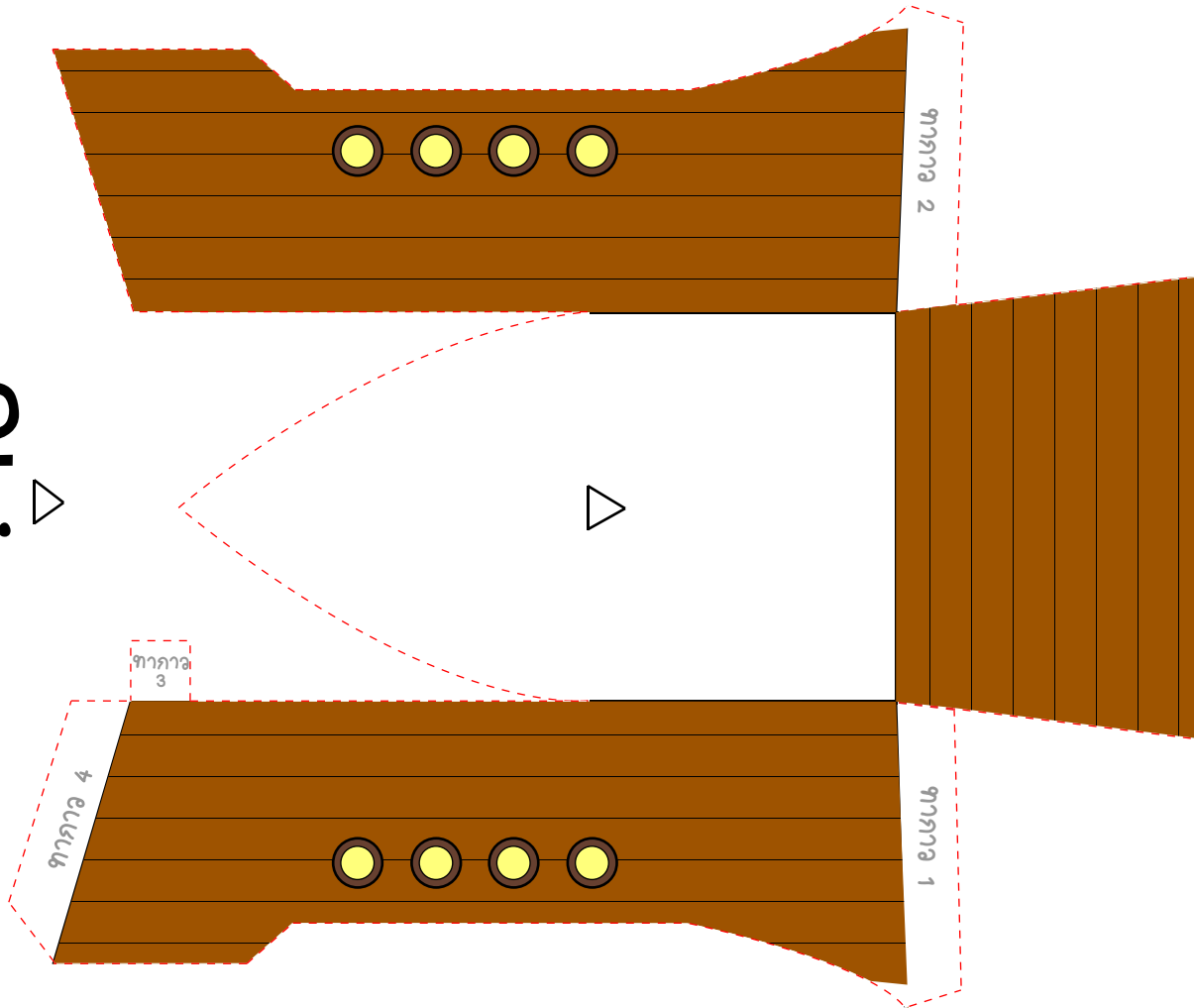

ทากาวด้านล่าง
เพื่อติดกับเรือ

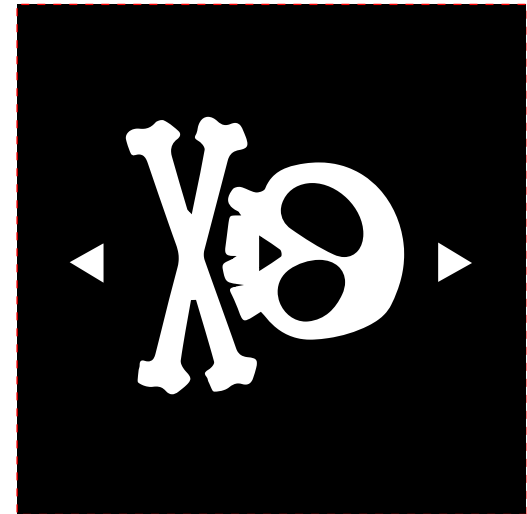
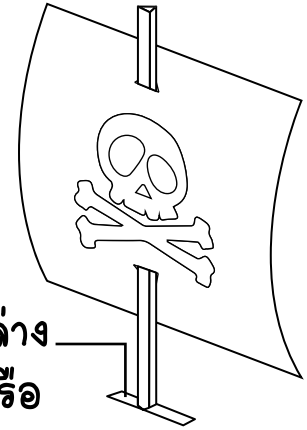

Flag

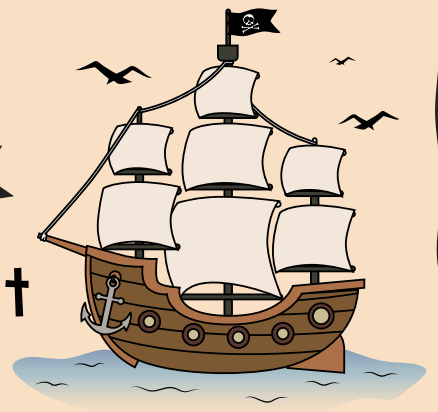
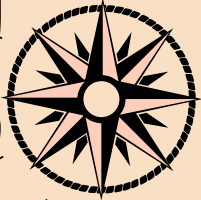

Start

2 — 1

3

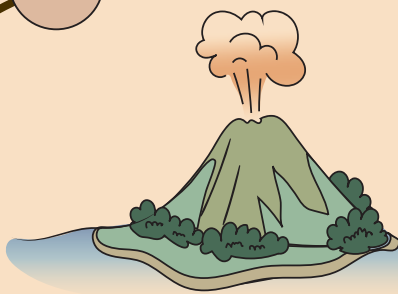

4

Move ahead 2 spaces!

5

6

Go back to start!

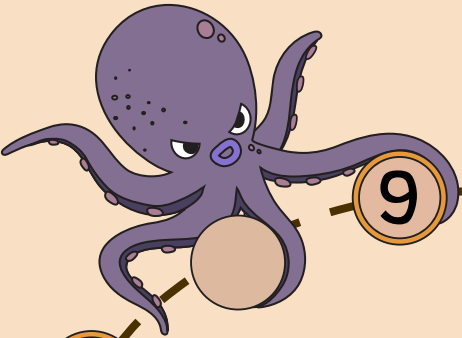

9

8



Spell

7

10

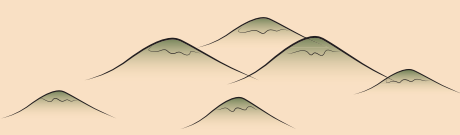

11

Miss a turn!

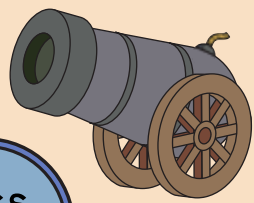

12



Finish

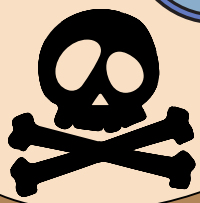

Board game

คำแนะนํ
เมื่อถึงคิวผู้เล่นหากเดินไปตกลงที่ช่องตัวเลข
ผู้เล่นจะต้องเติมคำศัพท์ลงบนใบงาน A



ลูกเต๋า

หมากเดิน



ใบงาน A

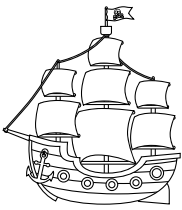

1. _____

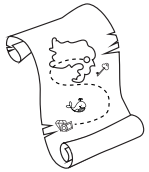

2. _____

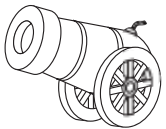

3. _____



4. _____



5. _____

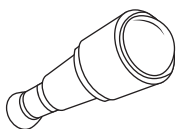

6. _____



7. _____

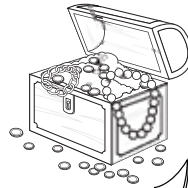

8. _____

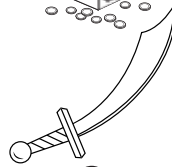

9. _____



10. _____

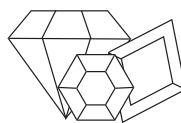

11. _____

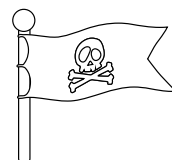

12. _____

Write the correct answer เติมคำตอบให้ถูกต้อง

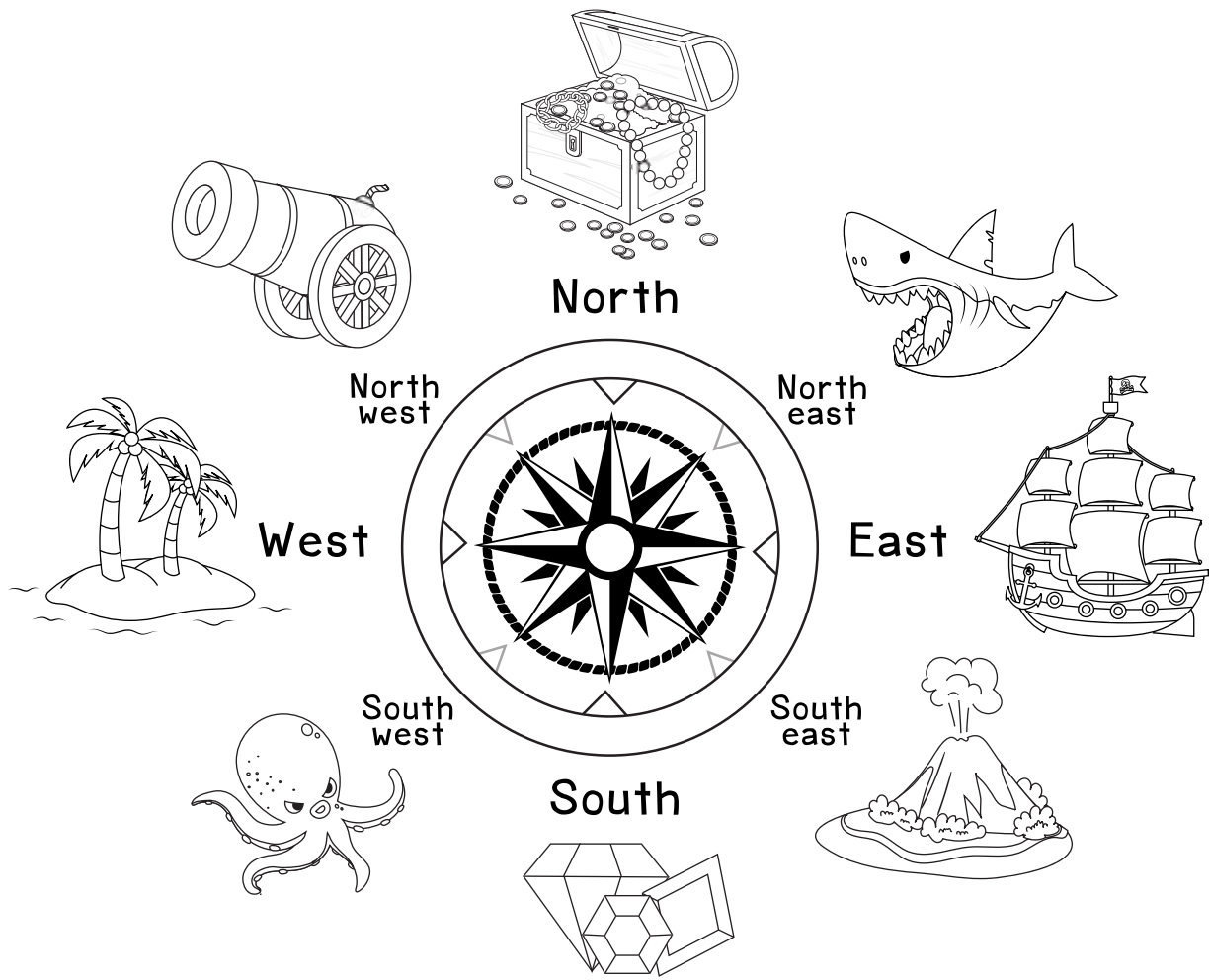

Is the pirate ship to the west or to the East? east

What direction should you sail to reach the island? west

If you don't like sharks, which direction should you avoid? northeast

Will you find the gems to the south or to the west? south

Will you find treasure to the north or to the southeast? north

What is the direction of the volcano? southeast

Will you find the cannon to the northwest or to the south? northwest

Where does the octopus live? southwest



ลูกเต๋า

หมากเดิน

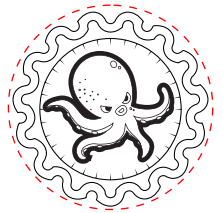

ใบงาน A

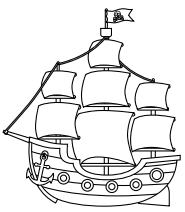

1. **Ship**



7. **Pirate**

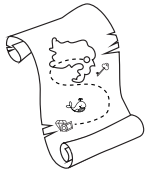

2. **Map**

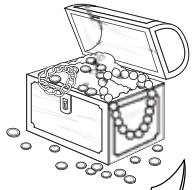

8. **Treasure**

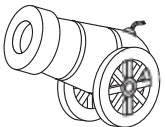

3. **Cannon**

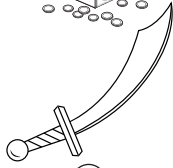

9. **Sword**



4. **Parrot**



10. **Compass**



5. **Island**

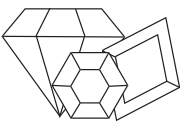

11. **Gems**

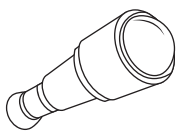

6. **Telescope**

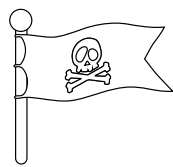

12. **Flag**