

# Hide and Seek

Where would the adverbs be? Let's take a peek.

ค้นหาคำวิเศษณ์

Underline the adverbs and hunt for them afterward!

1. My sister went to England.
2. The cat runs from the dog.
3. The airplane flies in the sky.
4. John cuts vegetables.
5. I make a bird house.
6. The students do experiments outside.
7. Mary wants to catch a butterfly.
8. We should always help others.
9. My father plants flowers.
10. Bob broke the cup.

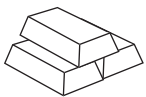
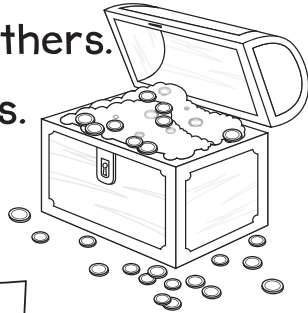

N	O	U	C	H	R	W	P	X	D	Z
V	T	L	S	S	U	C	E	L	B	L
S	T	P	T	H	N	O	S	N	E	V
G	T	N	X	B	S	K	E	O	T	H
I	A	N	C	C	T	K	I	J	K	S
W	C	U	A	S	J	G	L	Q	Z	I
G	T	D	H	L	K	P	F	S	U	D
S	E	K	A	M	P	O	M	Y	W	H
S	H	Z	S	L	G	D	O	H	T	J
T	I	B	R	O	K	E	A	U	Y	K
Y	N	I	U	O	Y	T	R	N	D	B

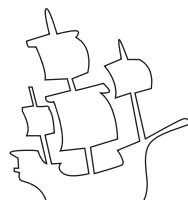
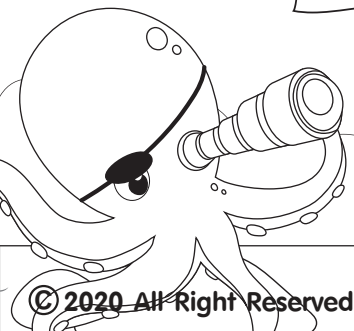

# Seek the correct adverbs.

เติมคำวิเศษณ์ที่ถูกต้อง



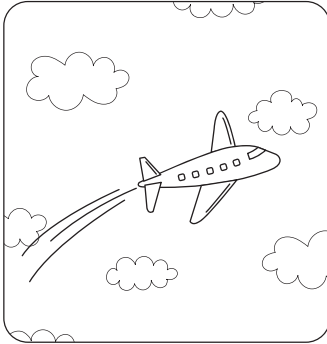

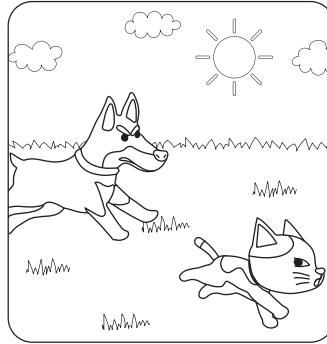

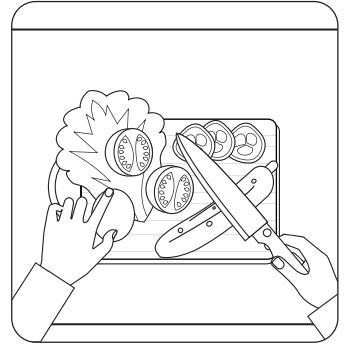

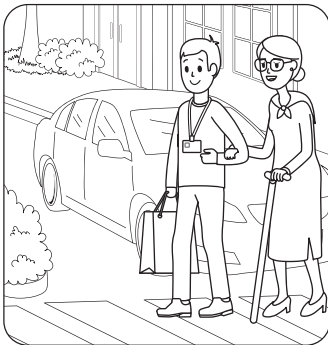

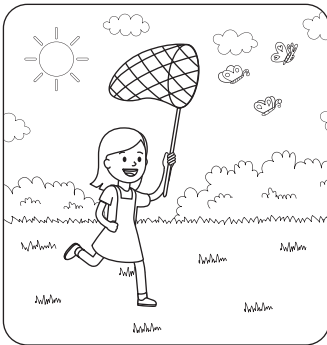







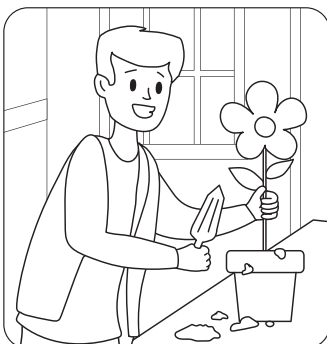



Depart

Chop

Escape

Soar

Capture

Assist

Conduct

Plot

Create

Shatter

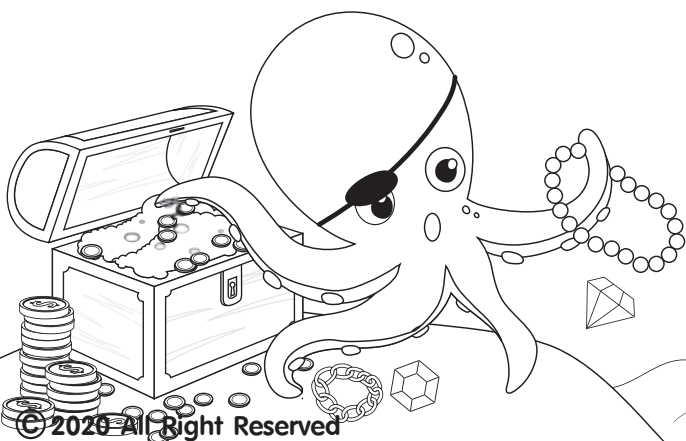

# Hide and Seek

Where would the adverbs be? Let's take a peek.

ค้นหาคำวิเศษณ์

Underline the adverbs and hunt for them afterwards!

1. The pirate finds treasure.
2. The spider eats bugs.
3. The dog hides his bone.
4. John hits Bob.
5. David understood Math.
6. My brother begins the race.
7. The baby cries all night.
8. I watch the stars.
9. The flower grows.
10. Susie chose the cat.

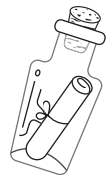
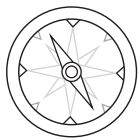
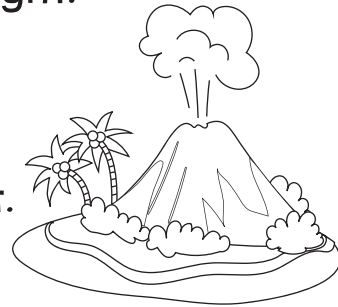

W	V	B	K	W	S	S	S	D	U	A
B	W	A	A	N	M	T	M	O	O	K
H	I	T	I	L	I	A	S	O	U	X
T	C	G	E	H	B	E	A	T	C	I
H	E	Z	H	S	W	M	S	S	R	E
B	S	W	X	I	O	P	R	R	I	P
F	I	N	D	S	D	H	F	E	E	M
V	A	W	E	Y	D	E	C	D	S	Z
S	W	O	R	G	K	S	S	N	T	R
X	T	L	M	E	G	D	X	U	Q	V
U	L	Z	G	H	P	Q	C	U	L	Q

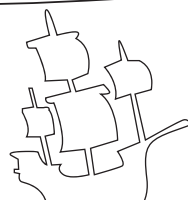
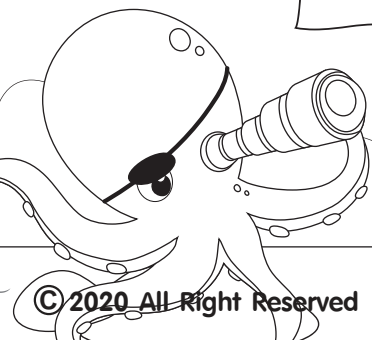

English Style Farang

www.esfworksheets.com

# Seek the correct adverbs.

เติมคำวิเศษณ์ที่ถูกต้อง

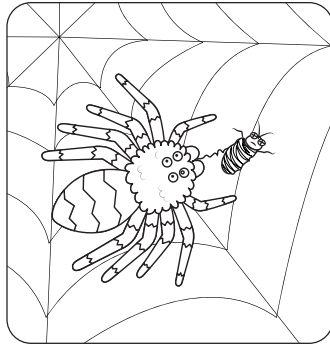
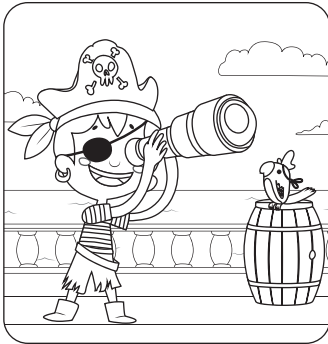



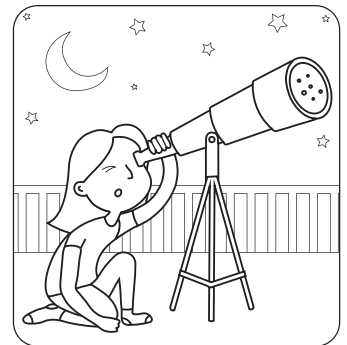
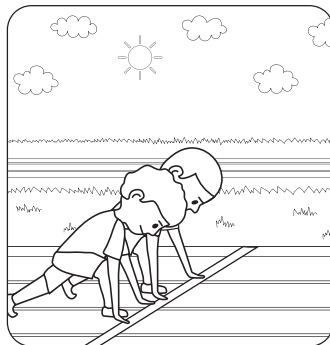
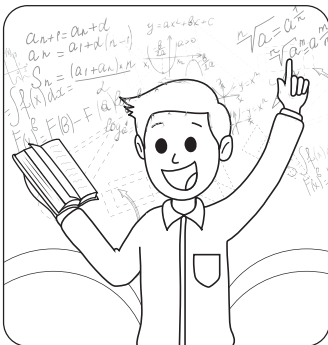

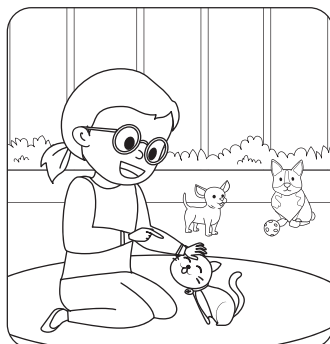
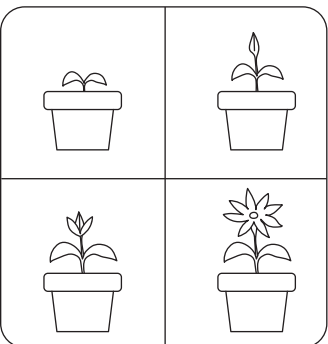

Discover

Start

Consume

Weep

Conceal

Observe

Strike

Flourish

Comprehend

Select

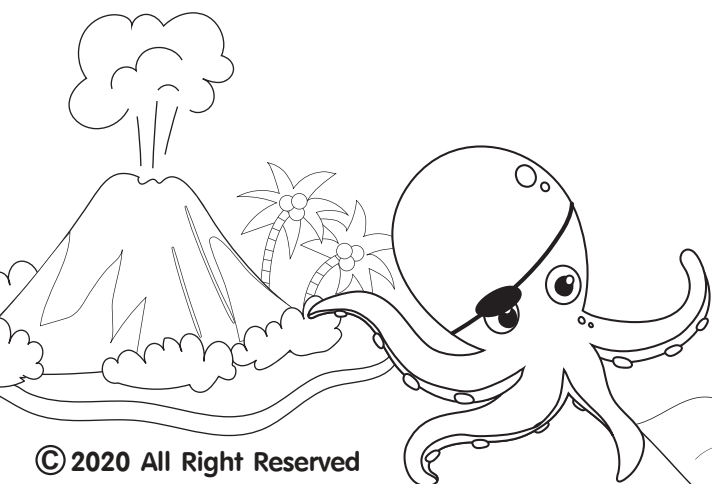

English Style Farang

www.esfworksheets.com

# Hide and Seek

Where would the Adjective be? Let's take a peek.

ค้นหาคุณศัพท์

Underline the adjectives and hunt for them afterwards!

1. The cartoon is funny.
2. Where is the tiny fish?
3. Look at that naughty cat.
4. I like the sparkling ring.
5. Dinner is tasty.
6. Strawberries are healthy.
7. My mother's car is clean?
8. Tom is handsome.
9. The giant dog is ours.
10. The cookies are hot.

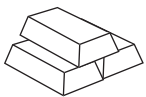
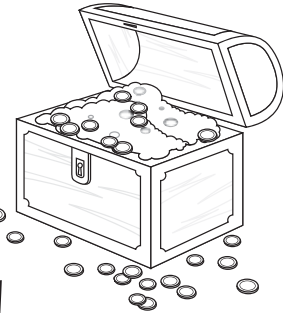

G	Y	G	H	Z	P	R	N	E	C	B
H	N	T	I	O	Y	L	A	G	X	V
H	E	I	S	A	T	Y	U	W	C	K
F	A	A	L	A	N	Z	G	M	K	Y
K	U	N	L	K	T	T	H	K	B	N
D	B	N	D	T	R	J	T	W	X	I
L	G	G	N	S	H	A	Y	W	G	T
Z	A	C	J	Y	O	Y	P	N	S	C
N	A	E	L	C	E	M	T	S	M	Y
S	H	V	F	H	X	B	E	J	K	A
P	O	T	J	Q	L	N	E	E	F	A

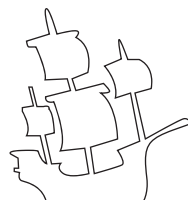
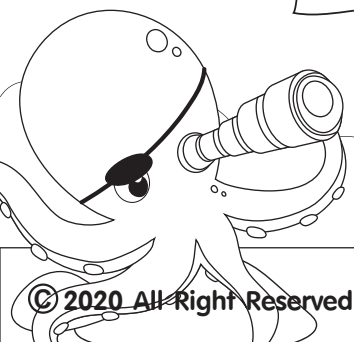
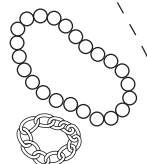

English Style Farang

www.esfworksheets.com

# Seek the correct adjective.

เติมคำคุณศัพท์ที่ถูกต้อง

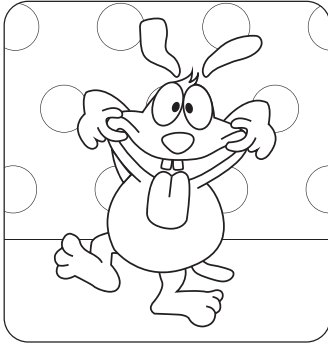

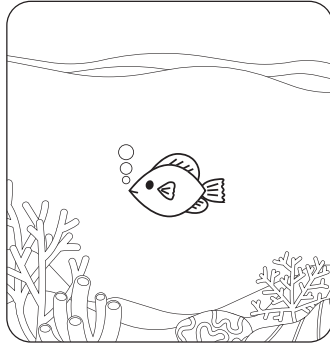



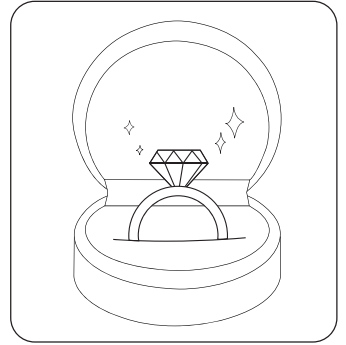



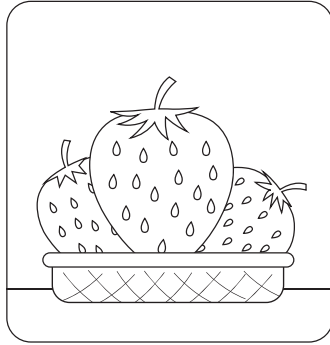



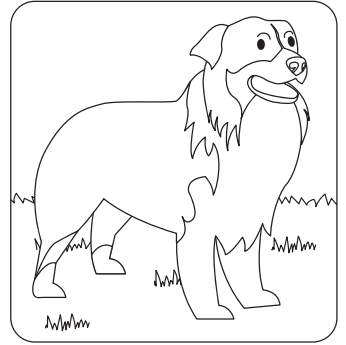

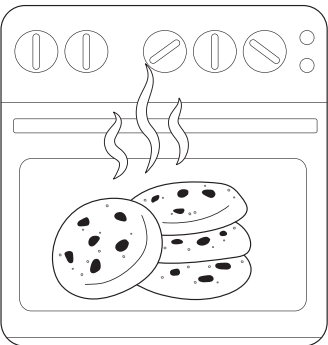

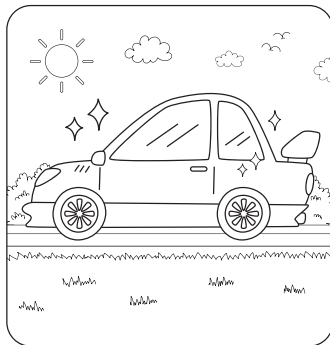



Mischievous

Miniature

Hilarious

Glinting

Delicious

Enormous

Spotless

Attractive

Nutritious

Scorching

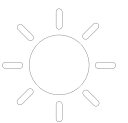
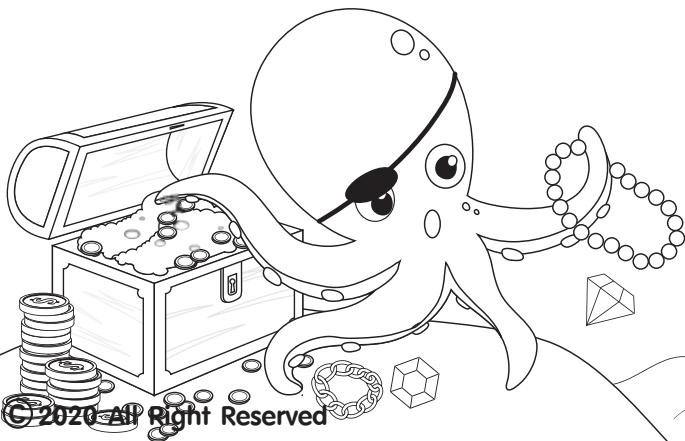

English Style Farang

www.esfworksheets.com

# Hide and Seek

Where would the Adjective be? Let's take a peek.

ค้นหาคุณศัพท์

Underline the adjectives and hunt for them afterwards!

1. I love to eat crunchy celery.
2. My uncle and I smell something funky.
3. The wind is chilly.
4. This is the first cellphone.
5. Smoking is bad for you.
6. Theme parks are always exciting.
7. The park is peaceful.
8. Sam is a clever student.
9. Is your car broken?
10. My mom makes perfect steaks.

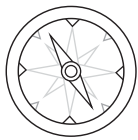
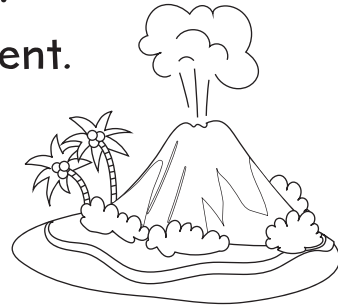

L	E	T	N	B	I	Y	F	I	V	Z
Q	U	X	C	Y	L	L	I	H	C	T
W	Z	F	C	E	F	I	R	S	T	D
Y	N	V	E	I	F	R	P	W	A	L
G	H	A	F	C	T	R	T	B	M	B
E	S	C	E	O	A	I	E	J	L	O
Z	I	X	N	D	K	E	N	P	A	F
J	O	H	O	U	C	G	P	G	T	Y
Y	K	N	U	F	R	Y	A	V	W	Y
R	E	V	E	L	C	C	Z	D	J	O
D	Z	G	W	M	B	R	O	K	E	N

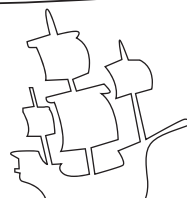
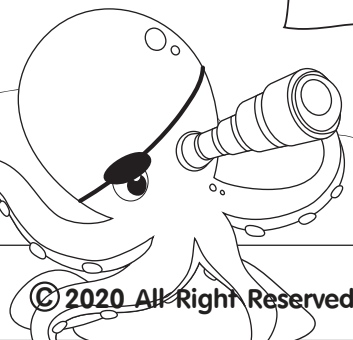
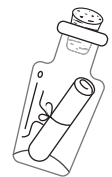

# Seek the correct adjective.

เติมคำคุณศัพท์ที่ถูกต้อง

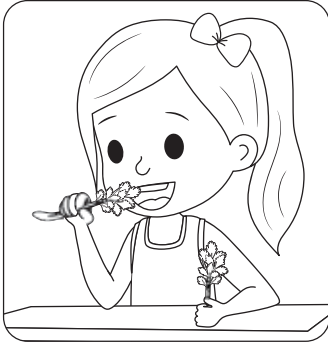





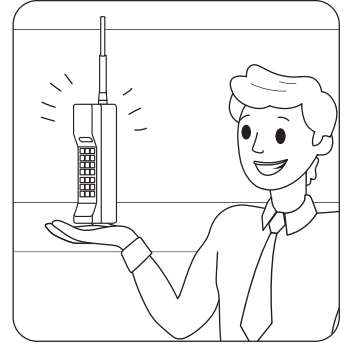





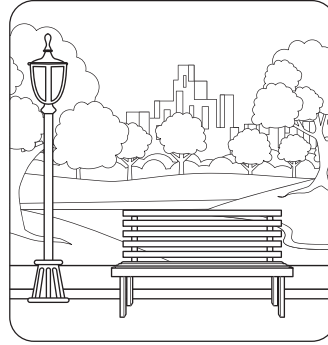



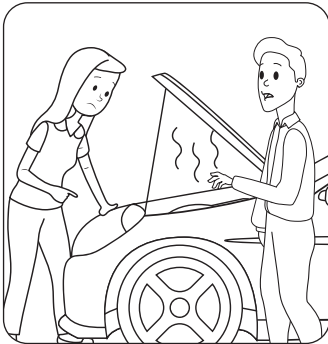

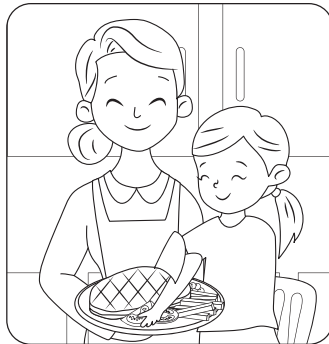



Crispy

Pungent

Cool

Original

Harmful

Brilliant

Calm

Thrilling

Damaged

Excellent

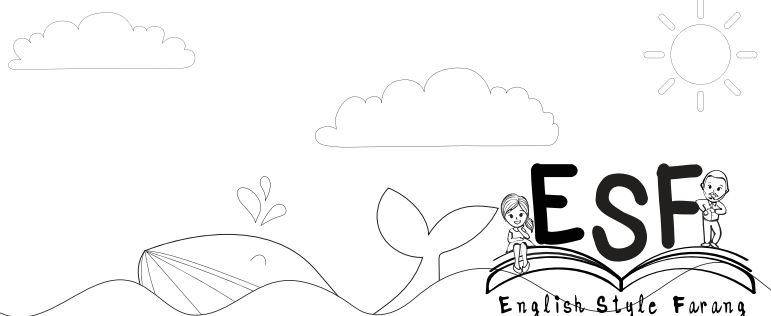
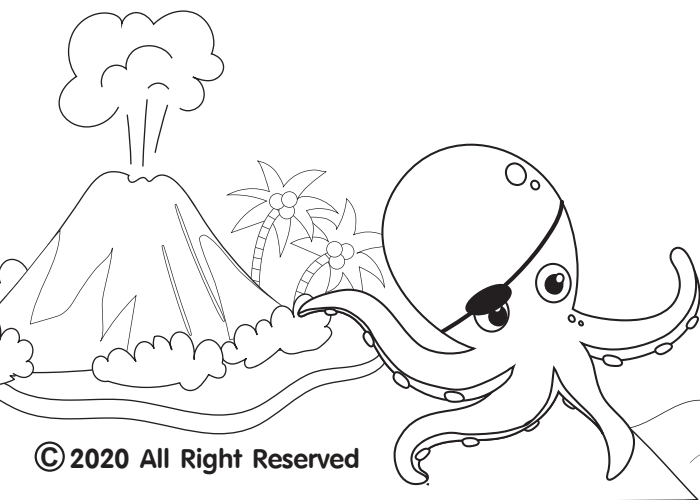

English Style Farang

www.esfworksheets.com



# Hide and Seek

Where would the adverbs be? Let's take a peek.

ค้นหาคำวิเศษณ์

Underline the adverbs and hunt for them afterward!

1. My sister went to England.
2. The cat runs from the dog.
3. The airplane flies in the sky.
4. John cuts vegetables.
5. I make a bird house.
6. The students do experiments outside.
7. Mary wants to catch a butterfly.
8. We should always help others.
9. My father plants flowers.
10. Bob broke the cup.

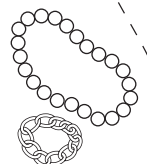
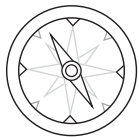
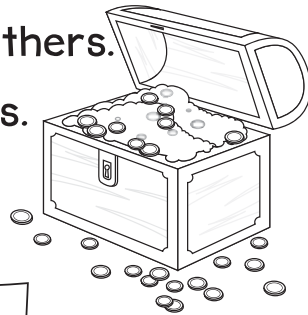

N	O	U	C	H	R	W	P	X	D	Z
V	T	L	S	S	U	C	E	L	B	L
S	T	P	T	H	N	O	S	N	E	V
G	T	N	X	B	S	K	E	O	T	H
I	A	N	C	C	T	K	I	J	K	S
W	C	U	A	S	J	G	L	Q	Z	I
G	T	D	H	L	K	P	F	S	U	D
S	E	K	A	M	P	O	M	Y	W	H
S	H	Z	S	L	G	D	O	H	T	J
T	I	B	R	O	K	E	A	U	Y	K
Y	N	I	U	O	Y	T	R	N	D	B

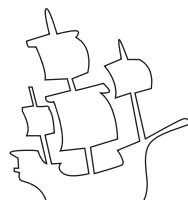
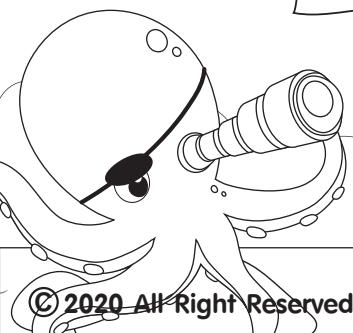

English Style Farang

www.esfworksheets.com

# Seek the correct adverbs.

เติมคำวิเศษณ์ที่ถูกต้อง



Depart

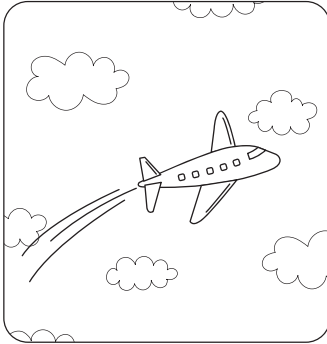

Conduct

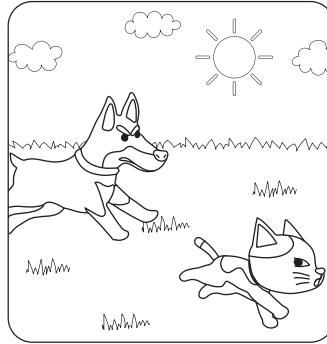

Escape

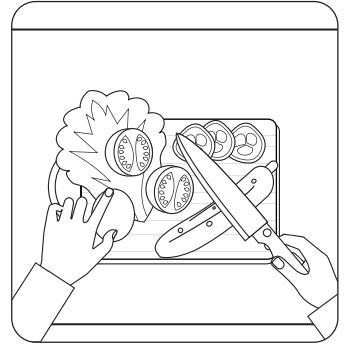

Chop

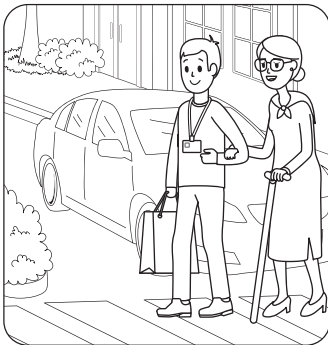

Assist

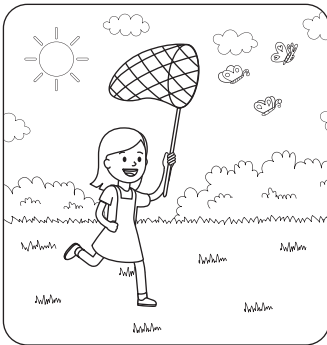

Capture



Shatter



Create



Soar



Plot

Depart

Chop

Escape

Soar

Capture

Assist

Conduct

Plot

Create

Shatter

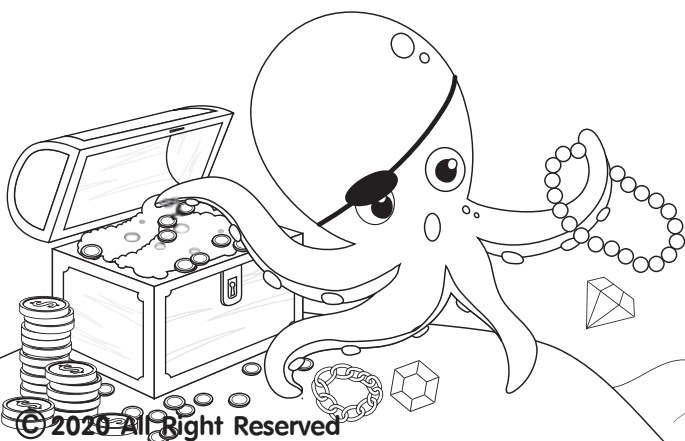

# Hide and Seek

Where would the adverbs be? Let's take a peek.

ค้นหาคำวิเศษณ์

Underline the adverbs and hunt for them afterwards!

1. The pirate finds treasure.
2. The spider eats bugs.
3. The dog hides his bone.
4. John hits Bob.
5. David understood Math.
6. My brother begins the race.
7. The baby cries all night.
8. I watch the stars.
9. The flower grows.
10. Susie chose the cat.

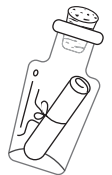
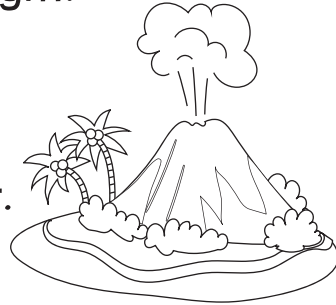

W	V	B	K	W	S	S	S	D	U	A
B	W	A	A	N	M	T	M	O	O	K
H	I	T	I	L	I	A	S	O	U	X
T	C	G	E	H	B	E	A	T	C	I
H	E	Z	H	S	W	M	S	S	R	E
B	S	W	X	I	O	P	R	R	I	P
F	I	N	D	S	D	H	F	E	E	M
V	A	W	E	Y	D	E	C	D	S	Z
S	W	O	R	G	K	S	S	N	T	R
X	T	L	M	E	G	D	X	U	Q	V
U	L	Z	G	H	P	Q	C	U	L	Q

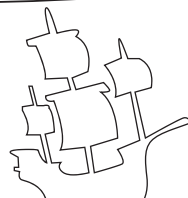
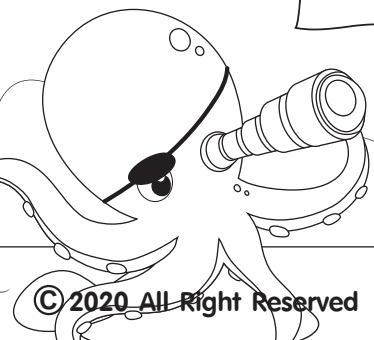

English Style Farang

www.esfworksheets.com

# Seek the correct adverbs.

เติมคำวิเศษณ์ที่ถูกต้อง

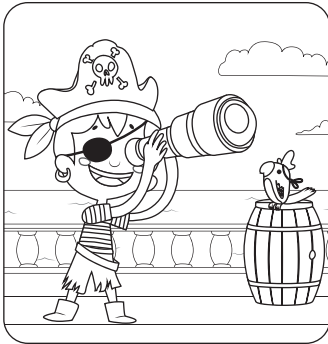

Discover

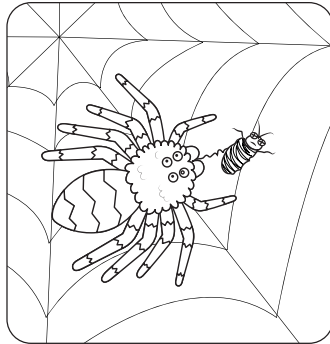

Consume



Conceal



Strike

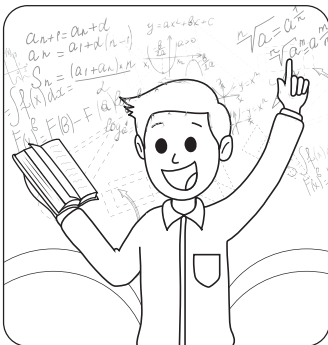

Comprehend

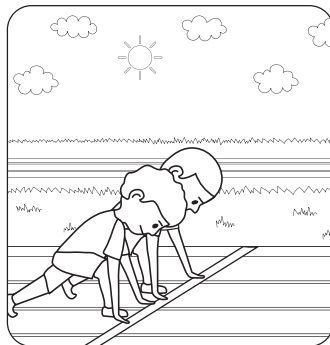

Start



Weep

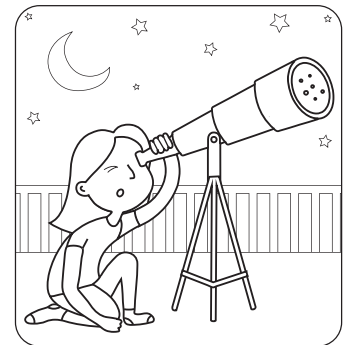

Observe

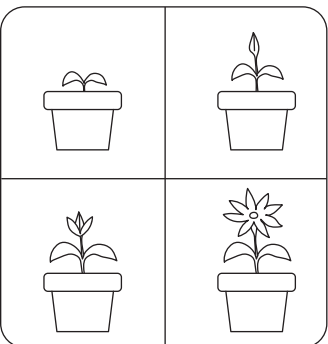

Flourish

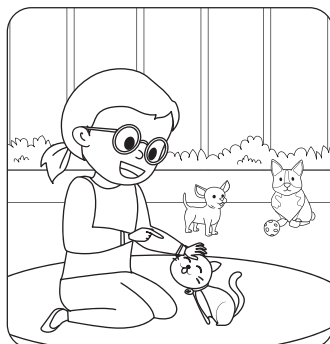

Select

Discover

Start

Consume

Weep

Conceal

Observe

Strike

Flourish

Comprehend

Select

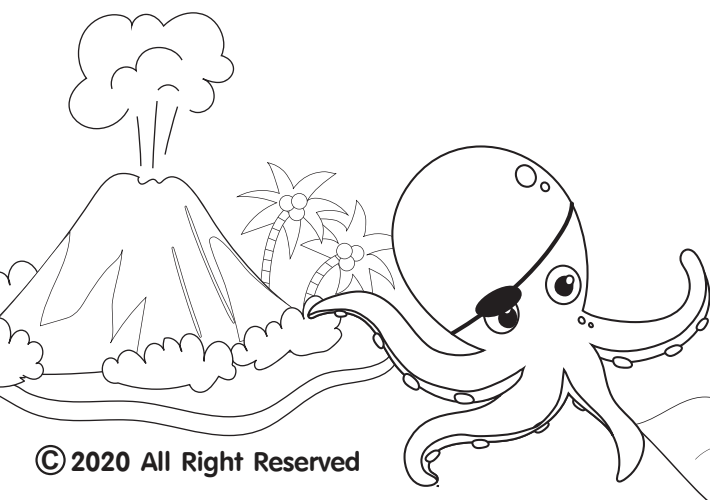

# Hide and Seek

Where would the Adjective be? Let's take a peek.

ค้นหาคุณศัพท์

Underline the adjectives and hunt for them afterwards!

1. The cartoon is funny.
2. Where is the tiny fish?
3. Look at that naughty cat.
4. I like the sparkling ring.
5. Dinner is tasty.
6. Strawberries are healthy.
7. My mother's car is clean?
8. Tom is handsome.
9. The giant dog is ours.
10. The cookies are hot.

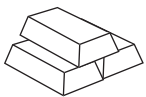
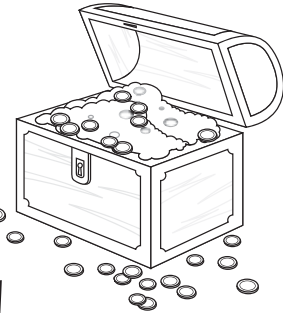

G	Y	G	H	Z	P	R	N	E	C	B
H	N	T	I	O	Y	L	A	G	X	V
H	E	I	S	A	T	Y	U	W	C	K
F	A	A	L	A	N	Z	G	M	K	Y
K	U	N	L	K	T	T	H	K	B	N
D	B	N	D	T	R	J	T	W	X	I
L	G	G	N	S	H	A	Y	W	G	T
Z	A	C	J	Y	O	Y	P	N	S	C
N	A	E	L	C	E	M	T	S	M	Y
S	H	V	F	H	X	B	E	J	K	A
P	O	T	J	Q	L	N	E	E	F	A

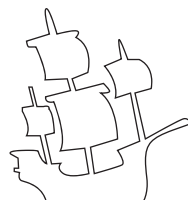
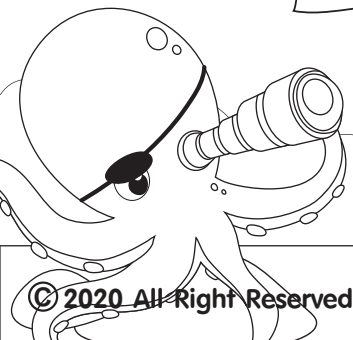

# Seek the correct adjective.

เติมคำคุณศัพท์ที่ถูกต้อง

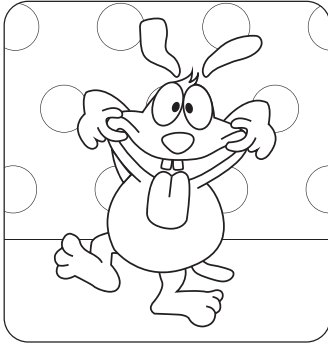

Hilarious

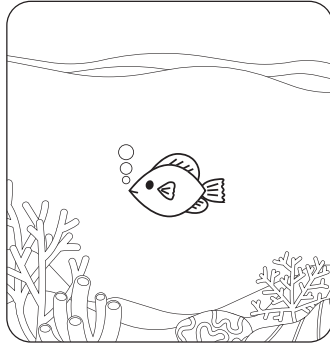

Miniature



Mischievous

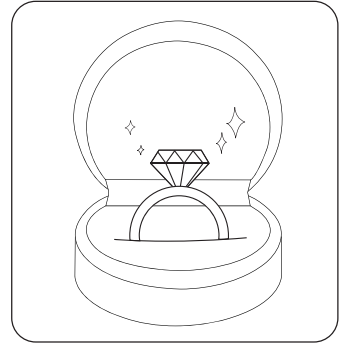

Glinting



Delicious

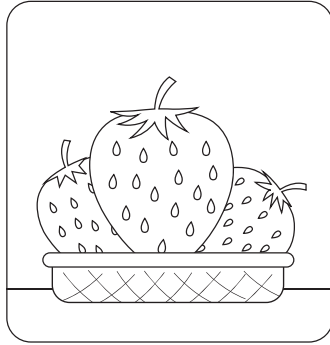

Nutritious



Attractive

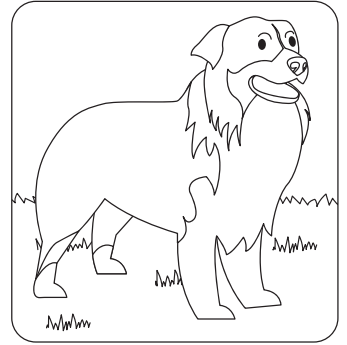

Enormous

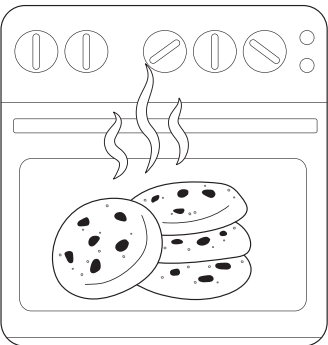

Scorching

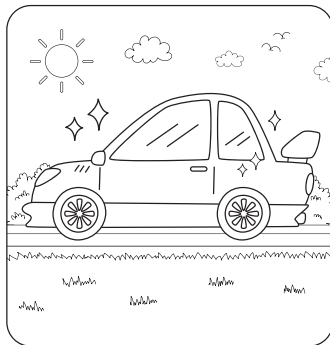

Spotless

Mischievous

Miniature

Hilarious

Glinting

Delicious

Enormous

Spotless

Attractive

Nutritious

Scorching

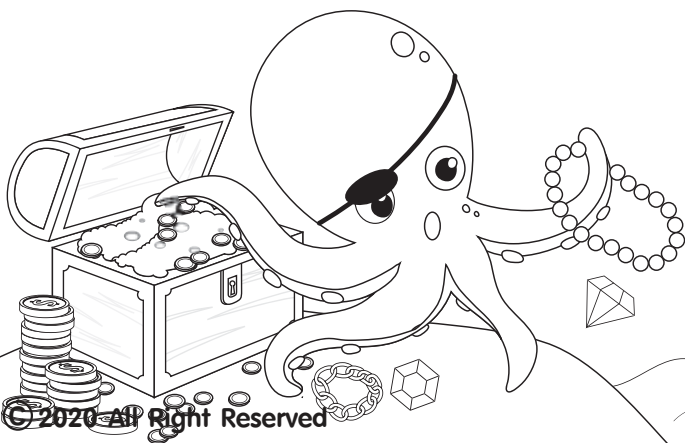

# Hide and Seek

Where would the Adjective be? Let's take a peek.

ค้นหาคุณศัพท์

Underline the adjectives and hunt for them afterwards!

1. I love to eat crunchy celery.
2. My uncle and I smell something funky.
3. The wind is chilly.
4. This is the first cellphone.
5. Smoking is bad for you.
6. Theme parks are always exciting.
7. The park is peaceful.
8. Sam is a clever student.
9. Is your car broken?
10. My mom makes perfect steaks.

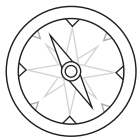
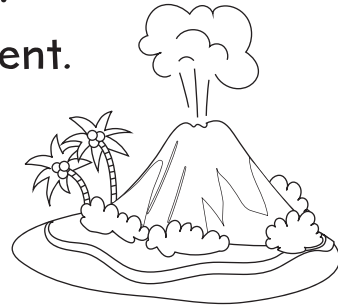

L	E	T	N	B	I	Y	F	I	V	Z
Q	U	X	C	Y	L	L	I	H	C	T
W	Z	F	C	E	F	I	R	S	T	D
Y	N	V	E	I	F	R	P	W	A	L
G	H	A	F	C	T	R	T	B	M	B
E	S	C	E	O	A	I	E	J	L	O
Z	I	X	N	D	K	E	N	P	A	F
J	O	H	O	U	C	G	P	G	T	Y
Y	K	N	U	F	R	Y	A	V	W	Y
R	E	V	E	L	C	C	Z	D	J	O
D	Z	G	W	M	B	R	O	K	E	N

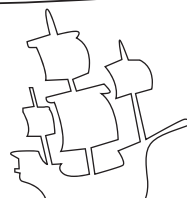
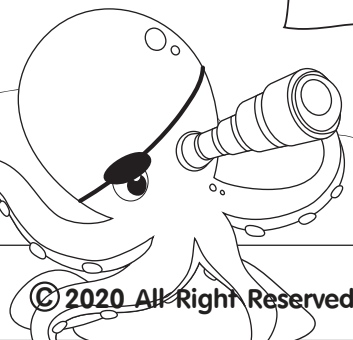
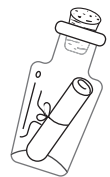

# Seek the correct adjective.

เติมคำคุณศัพท์ที่ถูกต้อง

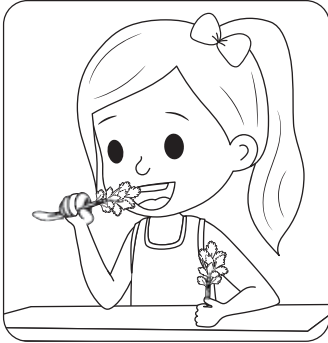

Crispy



Pungent



Cool

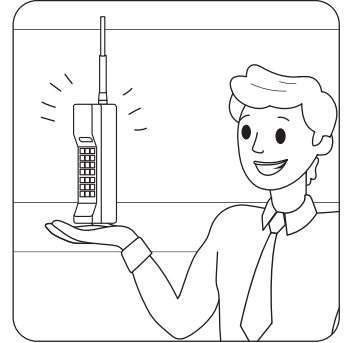

Original



Harmful



Thrilling



Calm



Brilliant

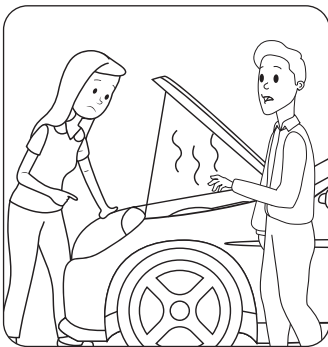

Damaged



Excellent

Crispy

Pungent

Cool

Original

Harmful

Brilliant

Calm

Thrilling

Damaged

Excellent

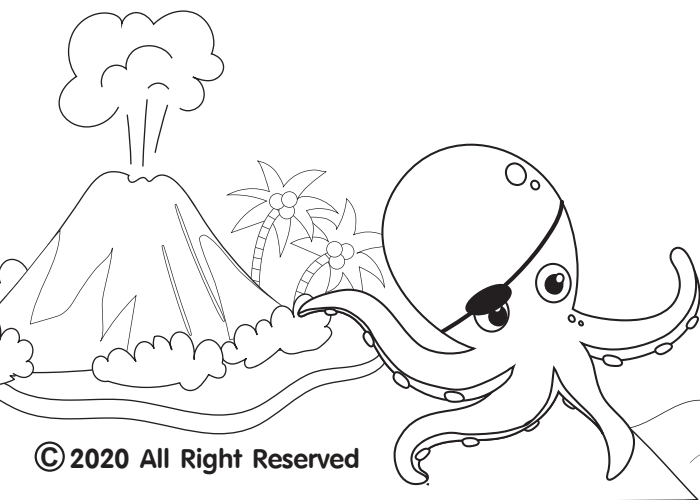

English Style Farang

www.esfworksheets.com