

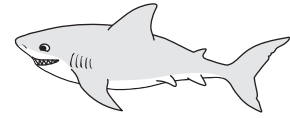

Shark Search



H I Y B K K W S T O B P W Z N K T C Z V
 O P C Y C R L E F C K Z D Q R G I F L Z
 S T H G O A H L V C D S R A R I G K W E
 O Y P W G H P Q Y S K N H J E A E R G Y
 L T W E W S W W M J M S D O S U R A D V
 K E H D A D S J B D D Y G U W B S H Y V
 V R O F B A S K I N G S H A R K H S P V
 B B A P S E V Q A F C L M O W O A O V N
 F K E H A H Z L J N G X S H N K R K A U
 G N W X S R N L U A A Q A T T D K A L W
 K W T B A E D S O V M L O Q E A D M L C
 H R N S E M T S F N E F U U I I B O Y J
 V V A R L M X I H S D F Q U L Z T H L I
 R Y G H S A J H H A B W T C B M D H R F
 J Q Q U S H Q A A W R H U V Z Y I H V Y
 X V N M Z L R U C F T K G S O O M U L T
 M A E S O K L H I R S A W J H T E M C B
 P U X W T P S U Z B E V E H G O E Y J U
 K R A H S E U L B U Q E E R R Z G A B I
 A N L W N U J V R M E Z R E G C L V K Q

Hammerhead shark

Basking shark

Tiger shark

Great white shark

Whale shark

Bull shark

Green land shark

Mako shark

Leopard shark

Blue shark



Shark Matching

Great White Shark

- Largest Reported:** "Deep Blue" was recorded to be an estimated 20 feet long and weighing around 2.5 tons.
- Average Size:** Great Whites range from 11 to 16 feet and can weigh from 1,151 to 2,450 pounds.
- Locations Found:** They live in coastal and offshore waters and like temperatures to be around 55 to 75°F.
- Characteristics:** The great white shark is the largest predatory fish that feeds on many large mammals and can swim up to 35 mph!

Hammerhead Shark

- Largest Reported:** The longest recorded hammerhead was 20 feet long and the heaviest recorded hammerhead weighed 991 pounds.
- Average Size:** Hammerheads average length are around 13.1 feet and can weigh 500 pounds.
- Locations Found:** Hammerheads like to stay in deeper waters along the coast.
- Characteristics:** They love eating crustaceans, bone fish and even their own.

Tiger Shark

- Largest Reported:** The longest tiger shark was to be around 18 feet long.
- Average Size:** Tiger sharks range from 10 to 14 feet and can weigh from 850 to 1,400 pounds.
- Locations Found:** They like to stay in more shallow waters in tropical areas.
- Characteristics:** Tiger sharks are very aggressive and will eat anything they see including garbage.



Shark Matching

Blue Shark

- Largest Reported:** A 20 foot blue shark was once reported but never recorded by scientists and the heaviest recorded blue shark weighed 861 pounds.
- Average Size:** Blue sharks range from 6.5 to 10 feet and can weigh from 60 to 400 pounds.
- Locations Found:** Blue sharks like to live in cooler waters and as far North as Norway and they like to swim close to the surface of the water.
- Characteristics:** They give birth to live young and its main diet is based on squid and fish.

Whale Shark

- Largest Reported:** The largest whale shark was recorded to be an estimated 41.5 feet long and weighing around 2.6 tons.
- Average Size:** Whale sharks average length is 32 feet and can weigh 20,000 pounds.
- Locations Found:** They like to stay in tropical areas swimming on the surface and diving as low as 5,900 feet deep.
- Characteristics:** Whale sharks are not aggressive as they eat small fish and plankton and also live up to 70 years.

Bull Shark

- Largest Reported:** The largest bull shark reported was around 771 pounds.
- Average Size:** Bull sharks range from 7 to 11 feet and can weigh 200 to 500 pounds.
- Locations Found:** They like to stay in tropical areas swimming the shorelines in salt and fresh water.
- Characteristics:** Bull sharks are very aggressive and are one the most dangerous towards humans.



Shark Matching

Basking Shark

- Largest Reported:** The largest basking shark reported was 40.3 feet.
- Average Size:** Basking sharks are normally around 26 feet and can weigh more than 9,000 pounds.
- Locations Found:** It swims on the surface and down to depths of 3,000 feet.
- Characteristics:** They are very large but are not aggressive and eat plankton mostly.

Leopard Shark

- Largest Reported:** The largest leopard shark recorded was 6.9 feet and 41 pounds.
- Average Size:** Leopard sharks range from 5 to 7 feet.
- Locations Found:** They like shallow waters with muddy bottoms to hide them.
- Characteristics:** These sharks are not aggressive towards humans and are quick to run away.

Mako Shark

- Largest Reported:** The largest leopard shark recorded was 12.2 feet and 1,323 pounds.
- Average Size:** Mako sharks average size is around 14.8 feet and 1,100 pounds.
- Locations Found:** They live in warm waters along the equator.
- Characteristics:** Makos are smart hunters that eat just about anything. They also love to jump out of the water!



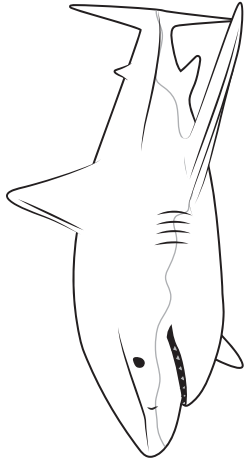

Great White Shark



Hammerhead Shark



Basking Shark



Blue Shark

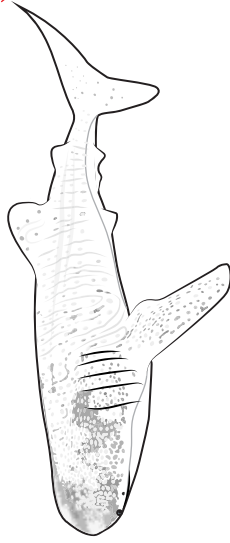

Whale Shark



Tiger Shark

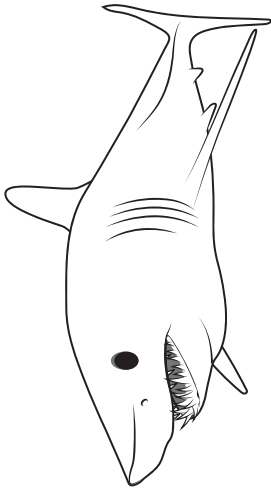

Mako Shark



Bull Shark



Greenland Shark

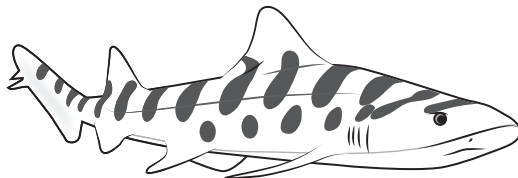

Leopard Shark



Shark Matching

Greenland Shark

Largest Reported: We think they can grow up to 21 feet and around 2,200 pounds.

Average Size: Greenland sharks range from 8 to 15.7 feet long and up to 880 pounds.

Locations Found: They love the cold waters and have been seen swimming around Canada and Iceland.

Characteristics: These sharks love to swim deep, around 7,200 feet deep! They also live between 300 to 500 years!



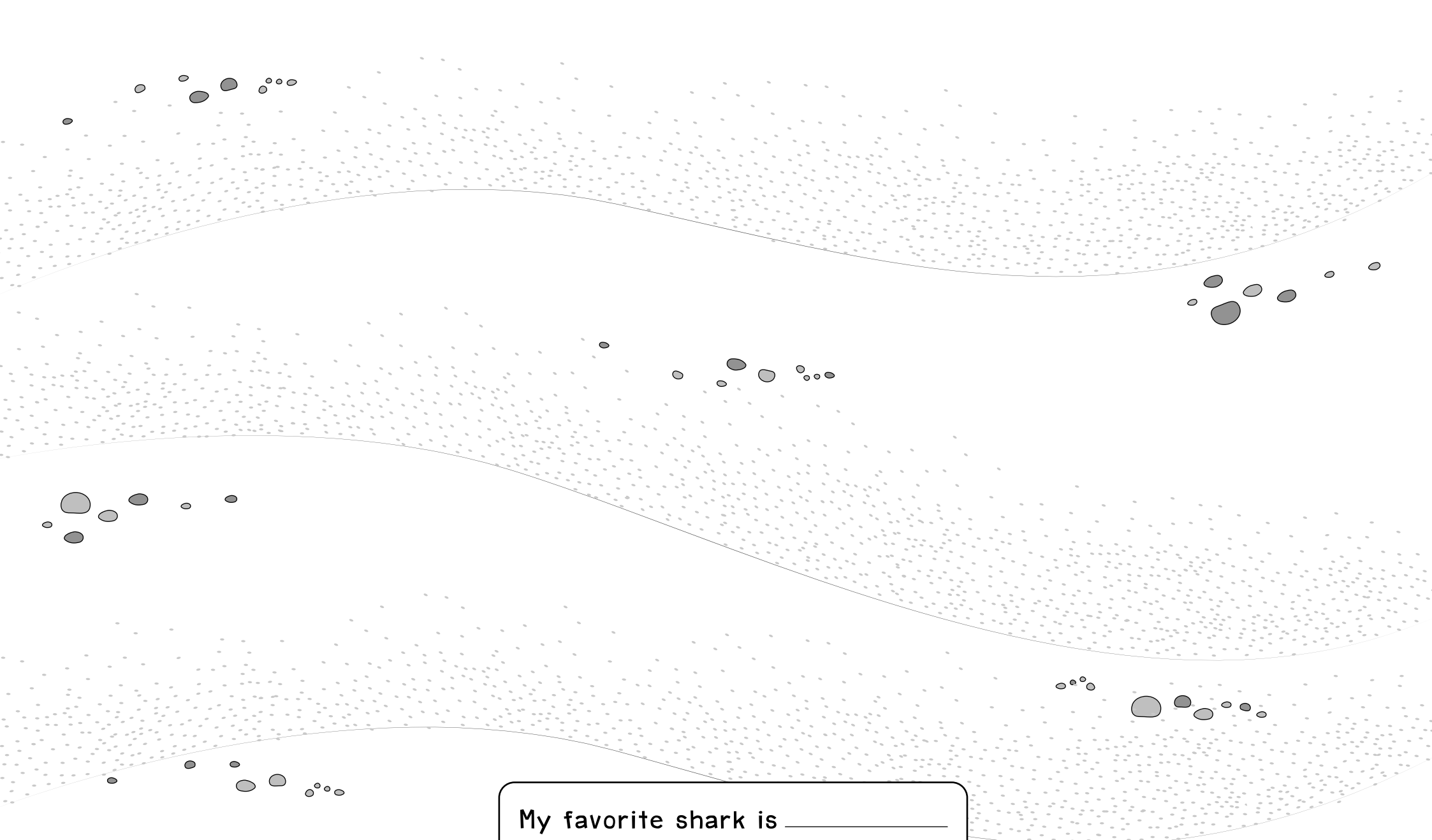

My favorite shark is _____

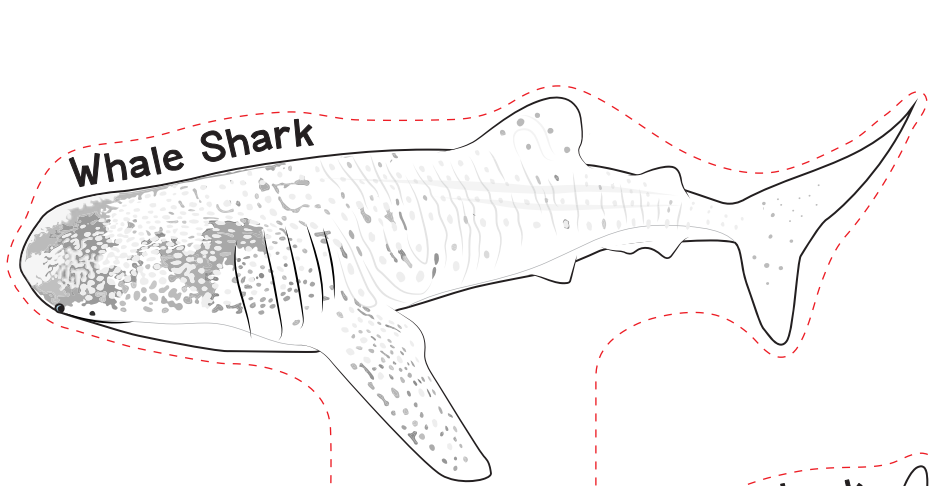

Whale Shark

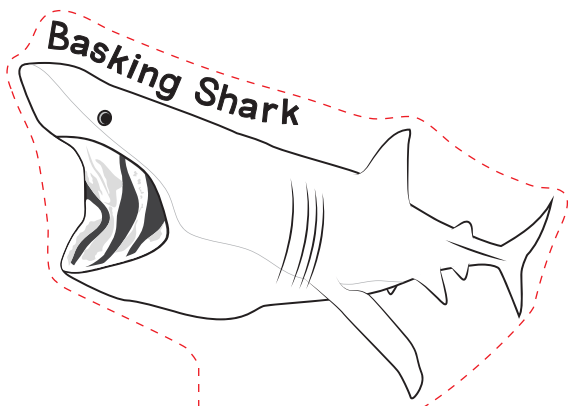

Basking Shark

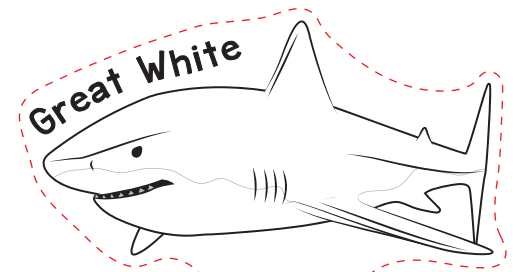

Great White



Leopard Shark

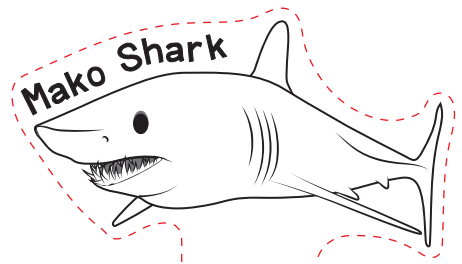

Mako Shark

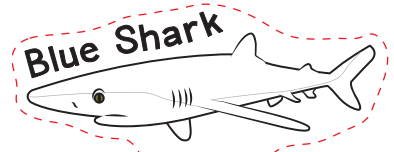

Blue Shark

ฉลาม

ฉลาม

ฉลาม

ฉลาม

ฉลาม ฉลาม

ฉลาม

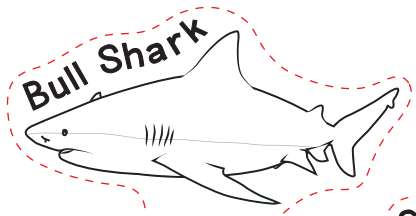

Bull Shark

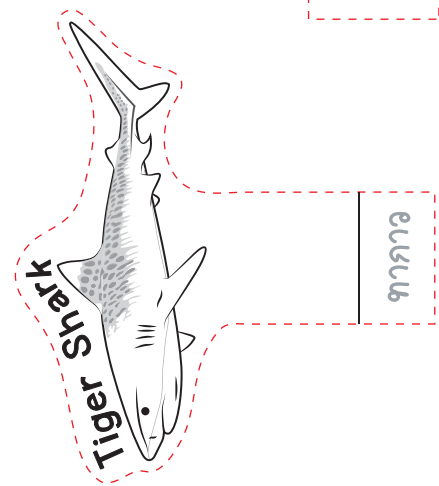

Tiger Shark

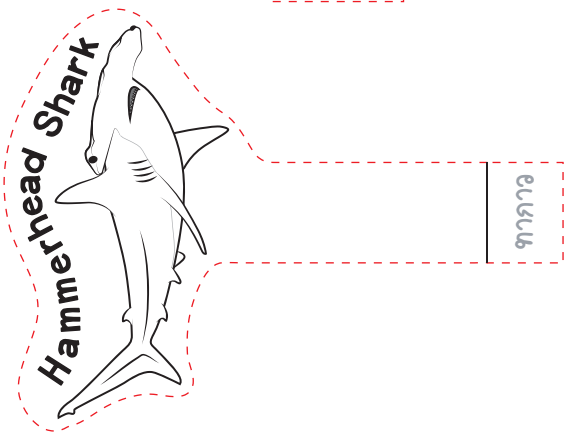

Hammerhead Shark

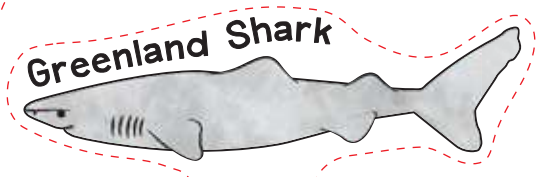

Greenland Shark

ฉลาม

ฉลาม

ฉลาม

ฉลาม



English Style Farang

www.esfworksheets.com

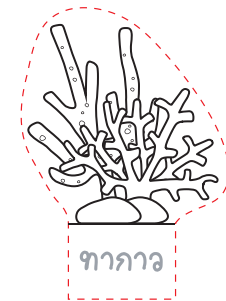
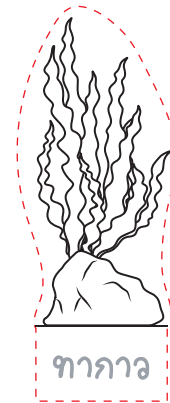
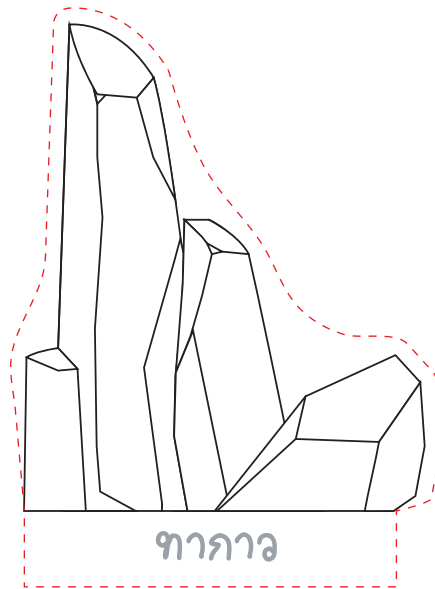
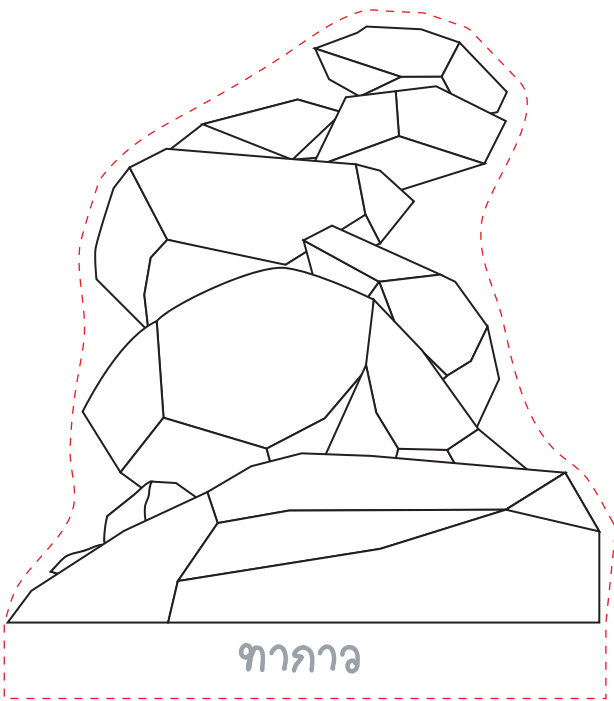
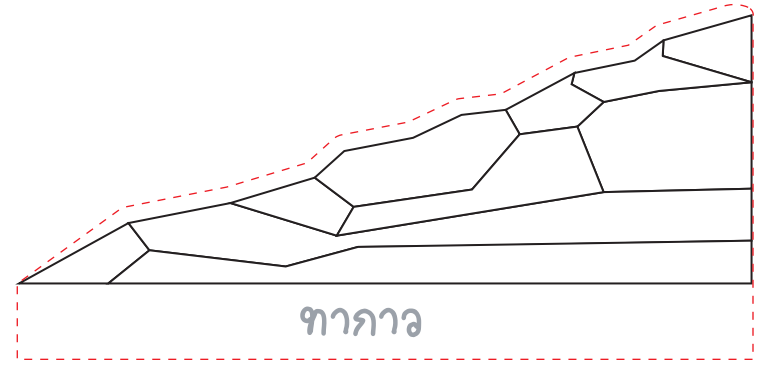
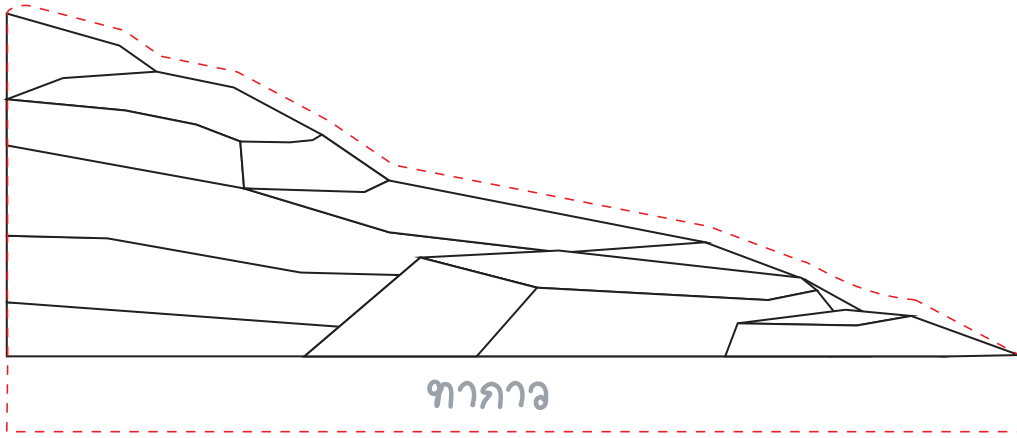



Shark Search

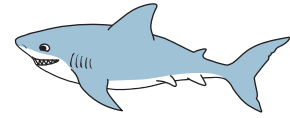

H I Y B K K W S T O B P W Z N K T C Z V
 O P C Y C R L E F C K Z D Q R G I F L Z
 S T H G O A H L V C D S R A R I G K W E
 O Y P W G H P Q Y S K N H J E A E R G Y
 L T W E W S W W M J M S D O S U R A D V
 K E H D A D S J B D D Y G U W B S H Y V
 V R O F B A S K I N G S H A R K H S P V
 B B A P S E V Q A F C L M O W O A O V N
 F K E H A H Z L J N G X S H N K R K A U
 G N W X S R N L U A A Q A T T D K A L W
 K W T B A E D S O V M L O Q E A D M L C
 H R N S E M T S F N E F U U I I B O Y J
 V V A R L M X I H S D F Q U L Z T H L I
 R Y G H S A J H H A B W T C B M D H R F
 J Q Q U S H Q A A W R H U V Z Y I H V Y
 X V N M Z L R U C F T K G S O O M U L T
 M A E S O K L H I R S A W J H T E M C B
 P U X W T P S U Z B E V E H G O E Y J U
 K R A H S E U L B U Q E E R R Z G A B I
 A N L W N U J V R M E Z R E G C L V K Q

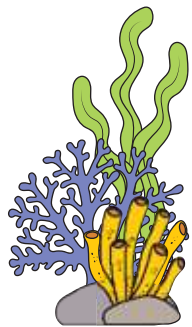

Hammerhead shark

Basking shark

Tiger shark

Great white shark

Whale shark

Bull shark

Green land shark

Mako shark

Leopard shark

Blue shark



Shark Matching

Great White Shark

- Largest Reported:** "Deep Blue" was recorded to be an estimated 20 feet long and weighing around 2.5 tons.
- Average Size:** Great Whites range from 11 to 16 feet and can weigh from 1,151 to 2,450 pounds.
- Locations Found:** They live in coastal and offshore waters and like temperatures to be around 55 to 75°F.
- Characteristics:** The great white shark is the largest predatory fish that feeds on many large mammals and can swim up to 35 mph!

Hammerhead Shark

- Largest Reported:** The longest recorded hammerhead was 20 feet long and the heaviest recorded hammerhead weighed 991 pounds.
- Average Size:** Hammerheads average length are around 13.1 feet and can weigh 500 pounds.
- Locations Found:** Hammerheads like to stay in deeper waters along the coast.
- Characteristics:** They love eating crustaceans, bone fish and even their own.

Tiger Shark

- Largest Reported:** The longest tiger shark was to be around 18 feet long.
- Average Size:** Tiger sharks range from 10 to 14 feet and can weigh from 850 to 1,400 pounds.
- Locations Found:** They like to stay in more shallow waters in tropical areas.
- Characteristics:** Tiger sharks are very aggressive and will eat anything they see including garbage.



Shark Matching

Blue Shark

- Largest Reported:** A 20 foot blue shark was once reported but never recorded by scientists and the heaviest recorded blue shark weighed 861 pounds.
- Average Size:** Blue sharks range from 6.5 to 10 feet and can weigh from 60 to 400 pounds.
- Locations Found:** Blue sharks like to live in cooler waters and as far North as Norway and they like to swim close to the surface of the water.
- Characteristics:** They give birth to live young and its main diet is based on squid and fish.

Whale Shark

- Largest Reported:** The largest whale shark was recorded to be an estimated 41.5 feet long and weighing around 2.6 tons.
- Average Size:** Whale sharks average length is 32 feet and can weigh 20,000 pounds.
- Locations Found:** They like to stay in tropical areas swimming on the surface and diving as low as 5,900 feet deep.
- Characteristics:** Whale sharks are not aggressive as they eat small fish and plankton and also live up to 70 years.

Bull Shark

- Largest Reported:** The largest bull shark reported was around 771 pounds.
- Average Size:** Bull sharks range from 7 to 11 feet and can weigh 200 to 500 pounds.
- Locations Found:** They like to stay in tropical areas swimming the shorelines in salt and fresh water.
- Characteristics:** Bull sharks are very aggressive and are one the most dangerous towards humans.



Shark Matching

Basking Shark

- Largest Reported:** The largest basking shark reported was 40.3 feet.
- Average Size:** Basking sharks are normally around 26 feet and can weigh more than 9,000 pounds.
- Locations Found:** It swims on the surface and down to depths of 3,000 feet.
- Characteristics:** They are very large but are not aggressive and eat plankton mostly.

Leopard Shark

- Largest Reported:** The largest leopard shark recorded was 6.9 feet and 41 pounds.
- Average Size:** Leopard sharks range from 5 to 7 feet.
- Locations Found:** They like shallow waters with muddy bottoms to hide them.
- Characteristics:** These sharks are not aggressive towards humans and are quick to run away.

Mako Shark

- Largest Reported:** The largest leopard shark recorded was 12.2 feet and 1,323 pounds.
- Average Size:** Mako sharks average size is around 14.8 feet and 1,100 pounds.
- Locations Found:** They live in warm waters along the equator.
- Characteristics:** Makos are smart hunters that eat just about anything. They also love to jump out of the water!



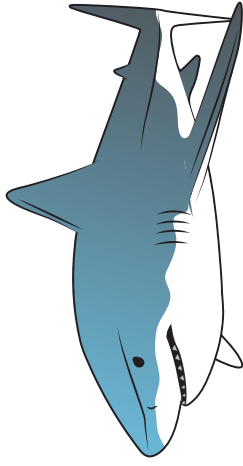

Great White Shark

ကုကာ

ကုကာ

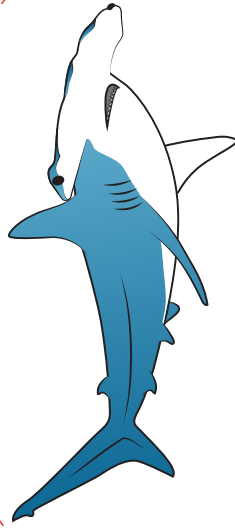

Hammerhead Shark

ကုကာ

ကုကာ

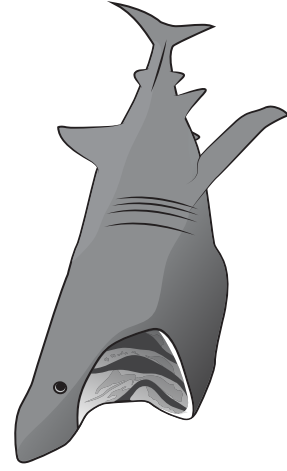

Basking Shark

ကုကာ

ကုကာ

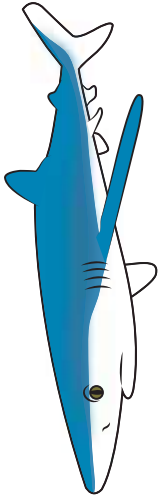

Blue Shark

ကုကာ

ကုကာ

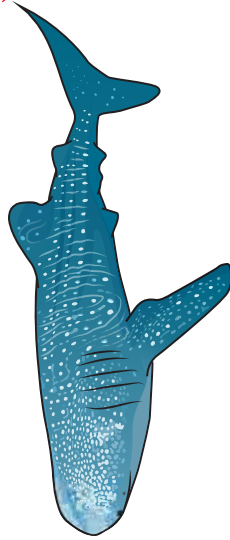

Whale Shark

ကုကာ

ကုကာ

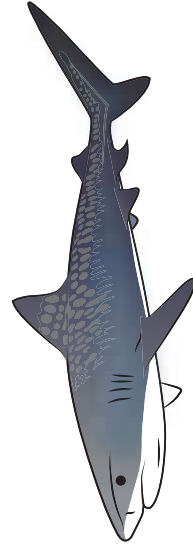

Tiger Shark

ကုကာ

ကုကာ

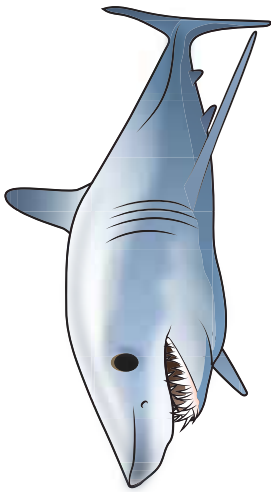

Mako Shark

ကုကာ

ကုကာ

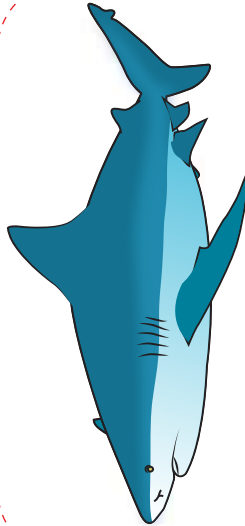

Bull Shark

ကုကာ

ကုကာ



Greenland Shark

ကုကာ

ကုကာ

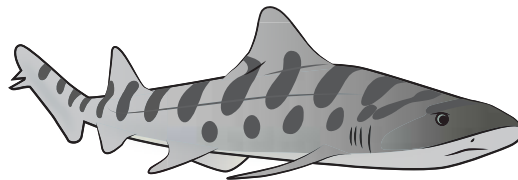

ကုကာ

Leopard Shark

ကုကာ



English Style Farang

www.esfworksheets.com

© 2020 All Right Reserved

Shark Matching

Greenland Shark

Largest Reported: We think they can grow up to 21 feet and around 2,200 pounds.

Average Size: Greenland sharks range from 8 to 15.7 feet long and up to 880 pounds.

Locations Found: They love the cold waters and have been seen swimming around Canada and Iceland.

Characteristics: These sharks love to swim deep, around 7,200 feet deep! They also live between 300 to 500 years!





My favorite shark is _____

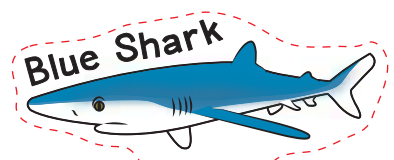
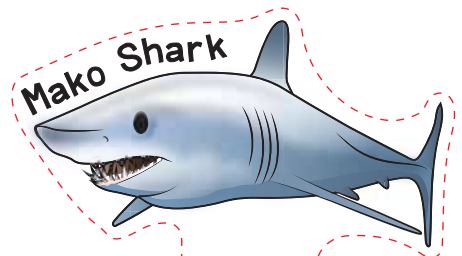
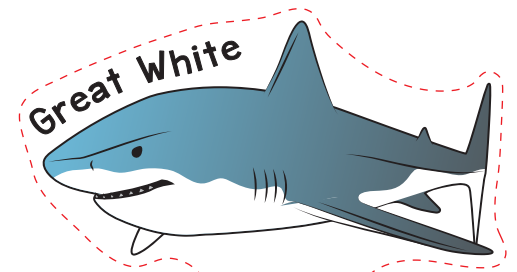
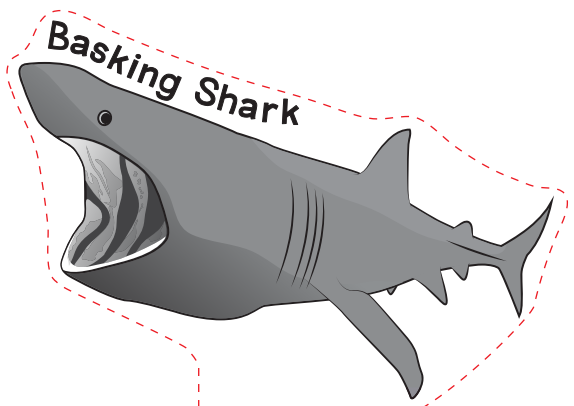
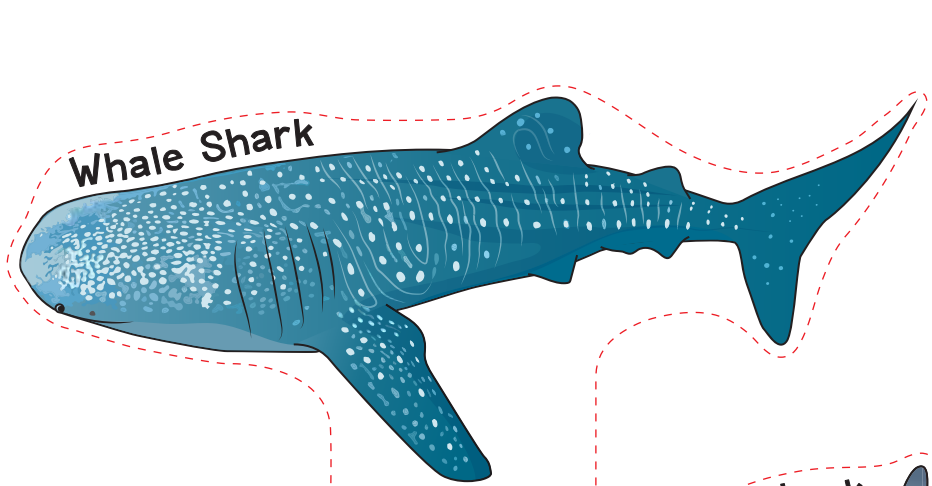

ทากาว

ทากาว

ทากาว

ทากาว

ทากาว ทากาว

ทากาว

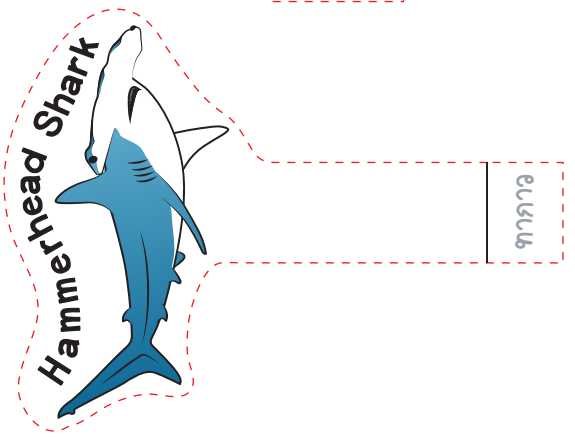
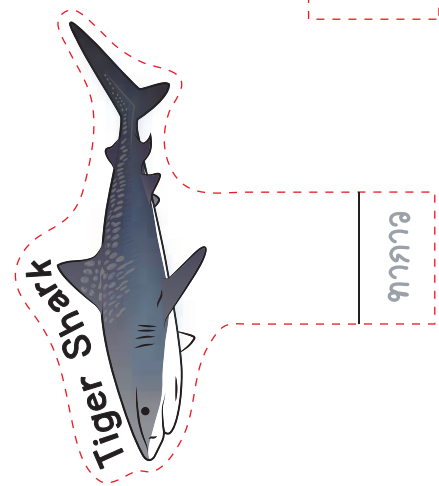
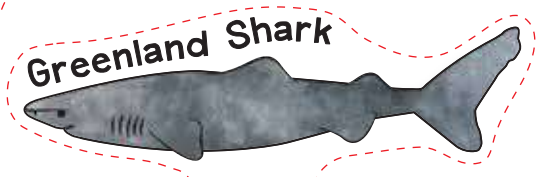
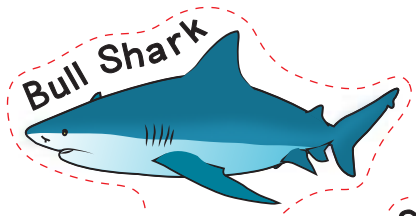

ทากาว

ทากาว

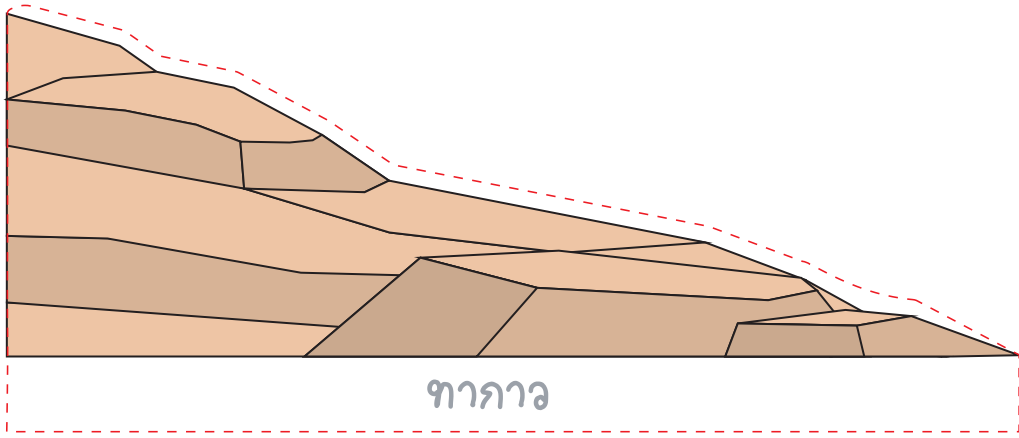

ຫາກາວ

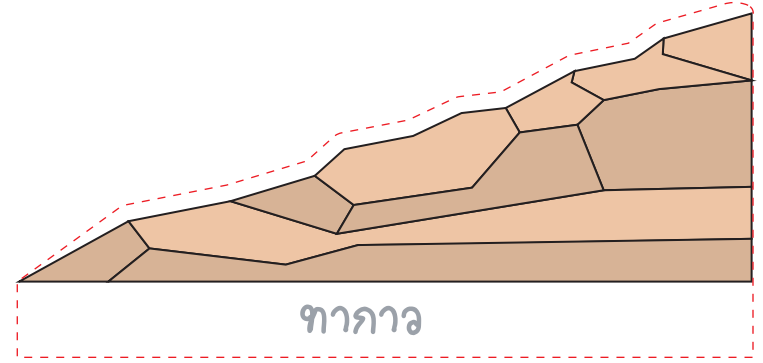

ຫາກາວ

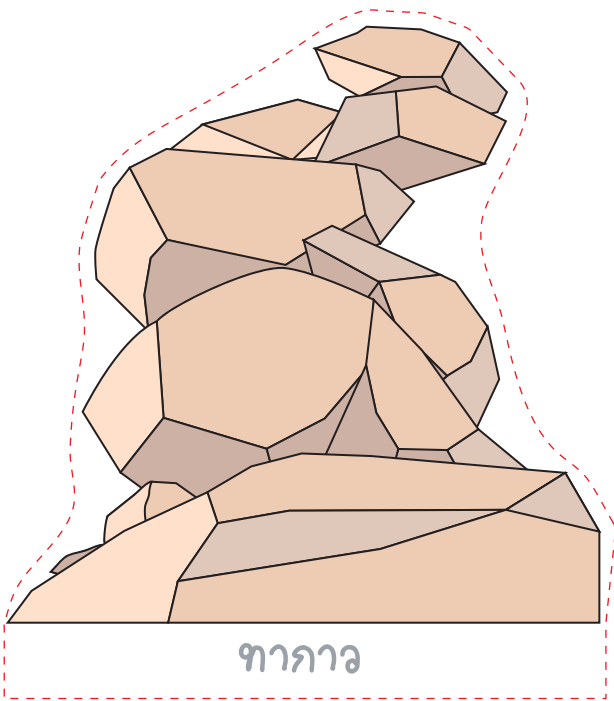

ຫາກາວ

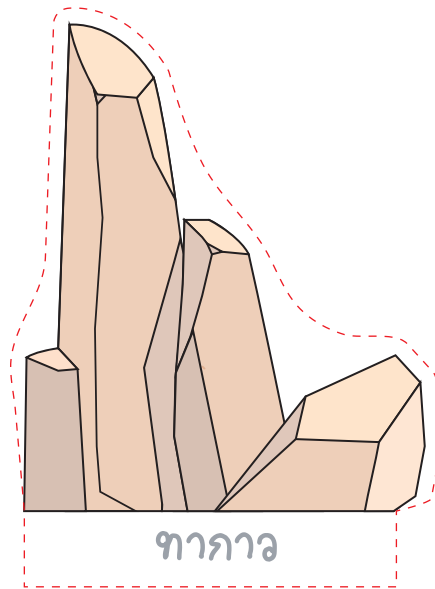

ຫາກາວ



ຫາກາວ

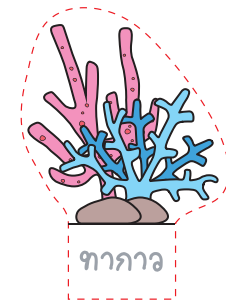

ຫາກາວ

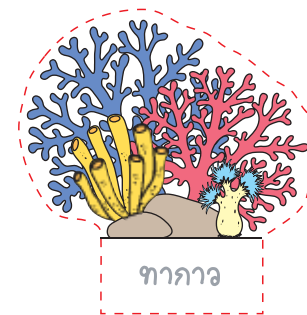

ຫາກາວ



Shark Search

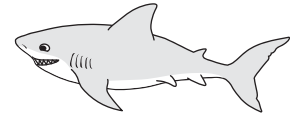

H I Y B K K W S T O B P W Z N K T C Z V
 O P C Y C R L E F C K Z D Q R G I F L Z
 S T H G O A H L V C D S R A R I G K W E
 O Y P W G H P Q Y S K N H J E A E R G Y
 L T W E W S W W M J M S D O S U R A D V
 K E H D A D S J B D D Y G U W B S H Y V
 V R O F B A S K I N G S H A R K H S P V
 B B A P S E V Q A F C L M O W O A O V N
 F K E H A H Z L J N G X S H N K R K A U
 G N W X S R N L U A A Q A T T D K A L W
 K W T B A E D S O V M L O Q E A D M L C
 H R N S E M T S F N E F U U I I B O Y J
 V V A R L M X I H S D F Q U L Z T H L I
 R Y G H S A J H H A B W T C B M D H R F
 J Q Q U S H Q A A W R H U V Z Y I H V Y
 X V N M Z L R U C F T K G S O O M U L T
 M A E S O K L H I R S A W J H T E M C B
 P U X W T P S U Z B E V E H G O E Y J U
 K R A H S E U L B U Q E E R R Z G A B I
 A N L W N U J V R M E Z R E G C L V K Q

Hammerhead shark

Basking shark

Tiger shark

Great white shark

Whale shark

Bull shark

Green land shark

Mako shark

Leopard shark

Blue shark

