

Independence Day Worksheet

1. What day is Independence Day? _____
2. What Year did America declare independence? _____
3. Who was the first President? _____
4. How many original colonies were there? _____
5. What is the capital city in the USA? _____

Draw the flag of 1776.

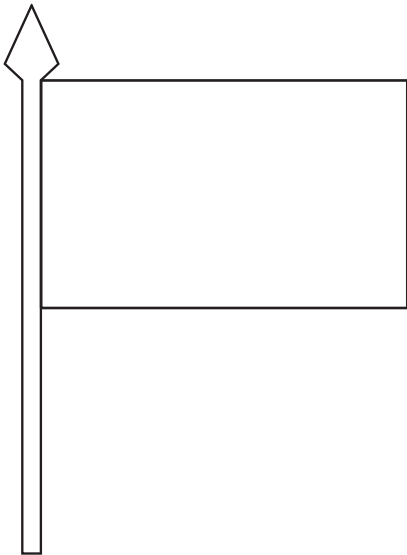

6. The stars represent : _____
7. The stripes represent : _____
8. What do the following represent?
Red : _____
White : _____
Blue : _____
9. What does the flag represent? _____
10. Once a flag is unrepairable you must : _____

Define Pledge of Allegiance Terms

- Allegiance : _____
- Flag : _____
- Republic : _____
- Nation : _____
- Indivisible : _____
- Liberty : _____
- Justice : _____

Declaration of Independence.

We the People

Of the United States, hold these Truths to be self-evident, that all men are created Equal, that they are endowed by their Creator with certain unalienable Rights, that among these are Life, Liberty and the pursuit of Happiness.

July 4, 1776



English Style Farang
www.esfworksheets.com

Pledge of Allegiance

I pledge allegiance
to the flag of the
United States of
America, and to the
Republic for which it
stands, one Nation
under God,
indivisible, with
liberty and justice
for all.

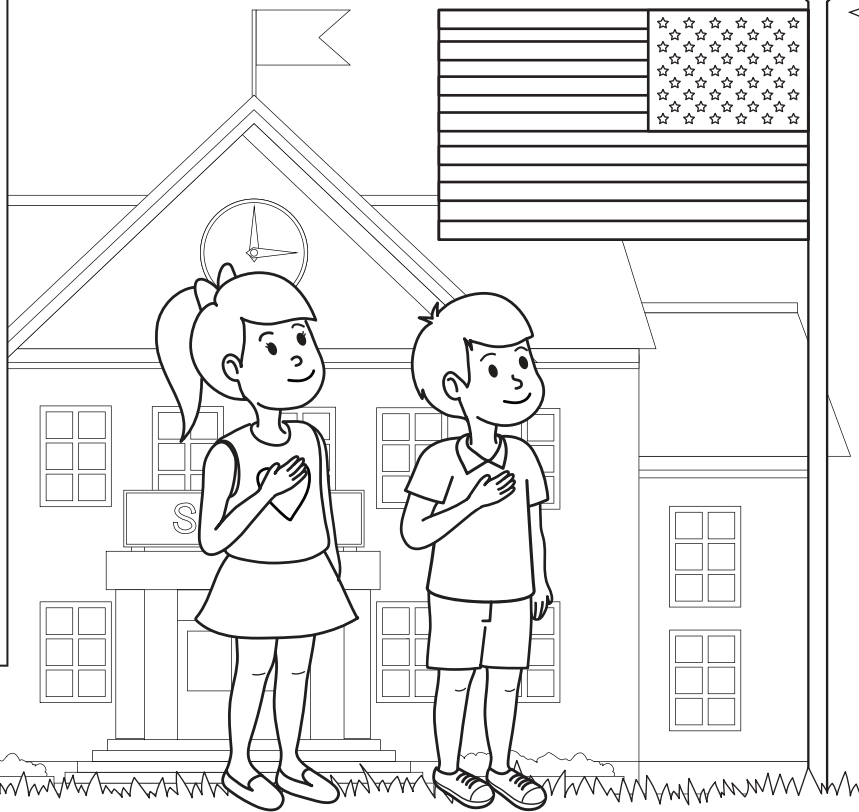

Match the following terms with the correct definitions

- | | |
|---------------|---|
| Allegiance • | • Cannot be divided. |
| Flag • | • A state in which the power is held by the people and the representatives they put in power. |
| Republic • | • Loyalty to a group of cause. |
| Nation • | • The ability to be free from oppressive views. |
| Indivisible • | • A large group of people that live in a country together united by history, culture, and language. |
| Liberty • | • A symbol or marker showing our independence. |
| Justice • | • A fairness for punishment according to the crime not status. |

American

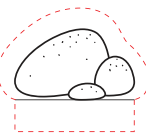
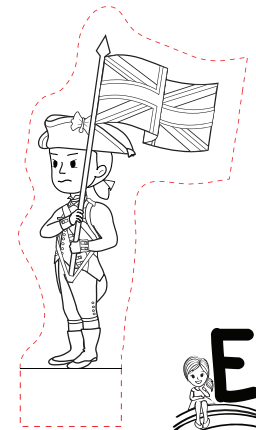
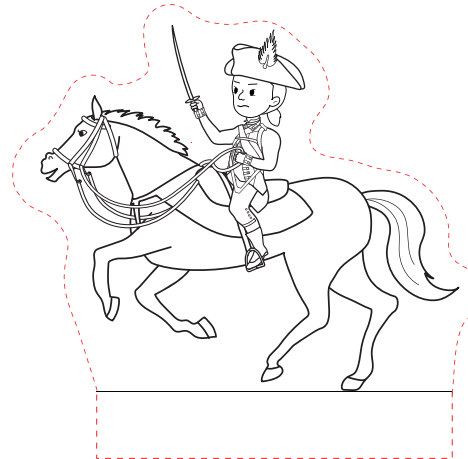
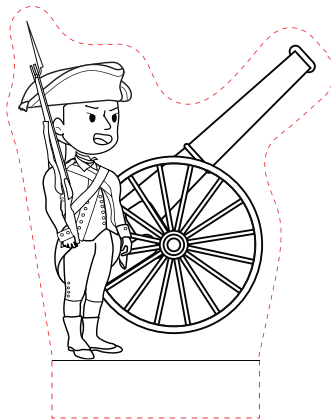
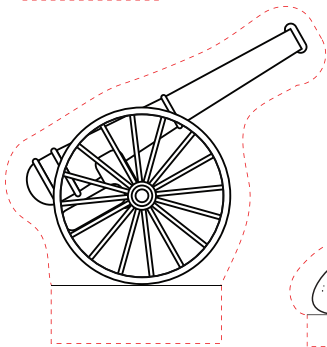
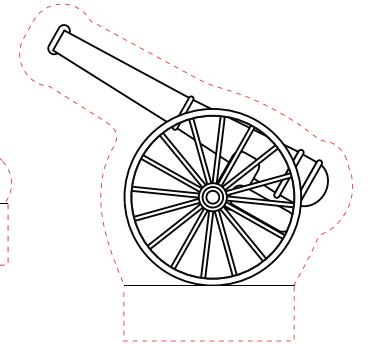
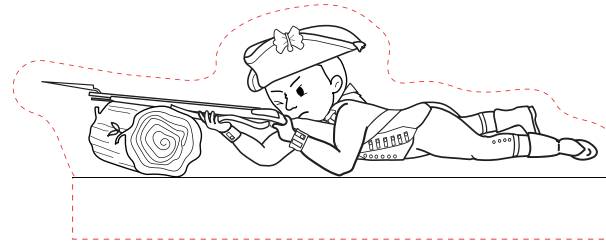
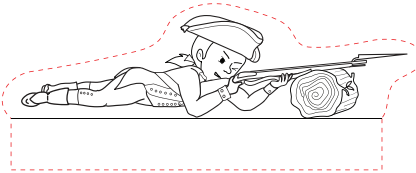
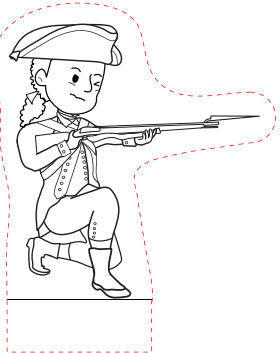
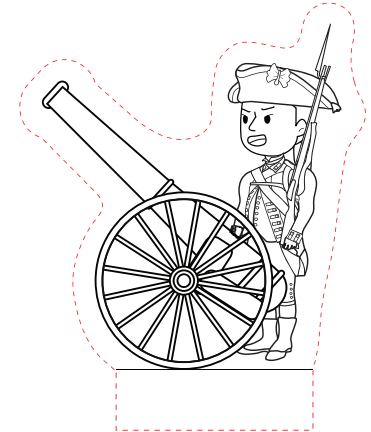
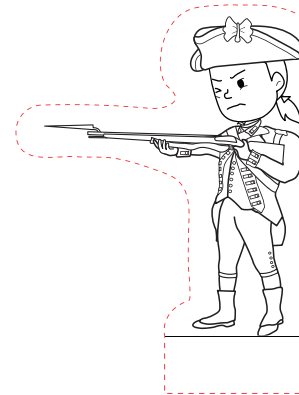
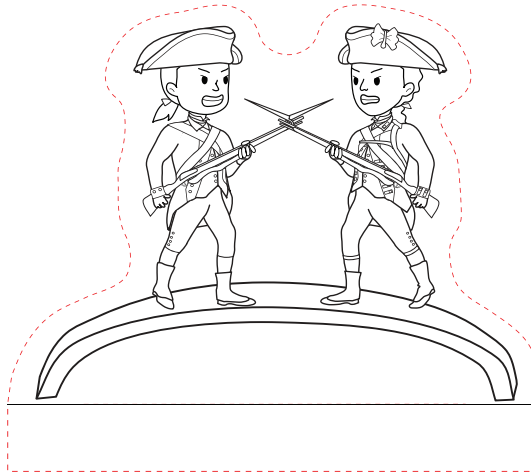
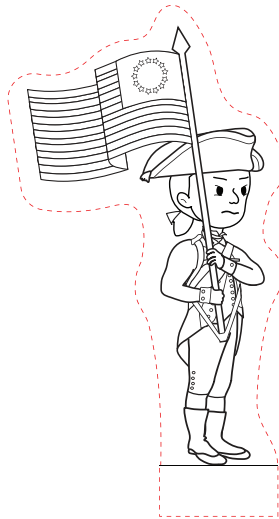
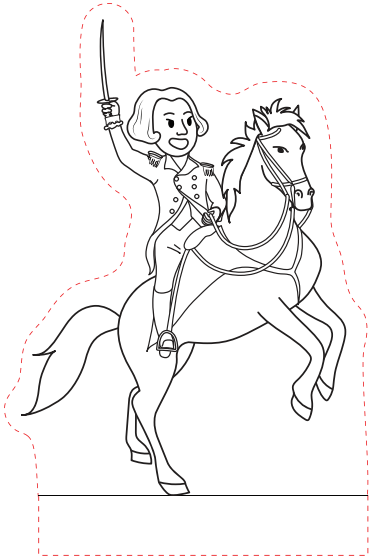

the American Revolution War

1775 - 1783

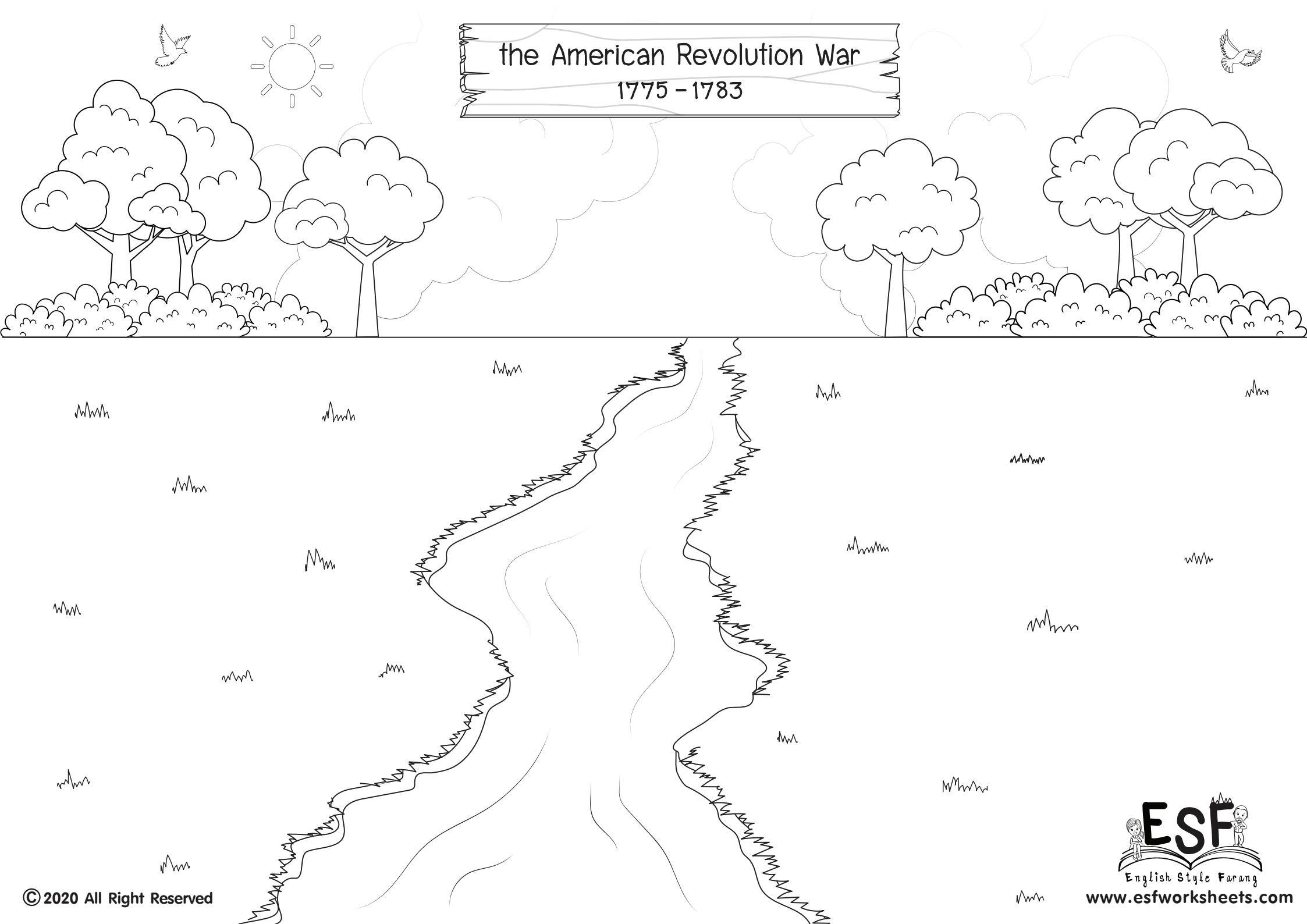

Fun Facts about our Flag

Flag of 1776

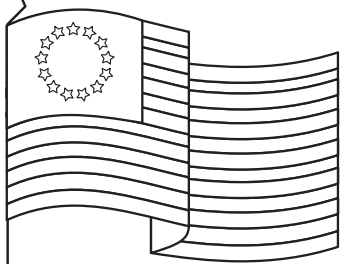

1. Our flag is a representation of independence.
2. The 13 stripes represent the original 13 colonies.
3. A man named Francis Bellamy wrote the Pledge of Allegiance in 1892.
4. the flag's colors are red, white and blue.
 - Red represents Valour.
 - White represents Liberty and Purity.
 - Blue represents Justice and Loyalty.
5. Betsy Ross sewed the original American flag in 1776.
6. Nick names for the American flag are Old Glory, Stars and Stripes, and Star Spangled Banner.
7. The World's largest American flag is 505ftx225ft and weighs around 3,000lbs.
8. As the country began to grow so did the amount of states. As the number of states grew we began to add more and more stars.
9. Once a flag becomes unrepairable, it must be destroyed in a dignified manner such as burning it.
10. The flag is to be displayed from sunrise to sunset, the flag can be displayed for 24 hours if it is lit up at night.

Present day flag

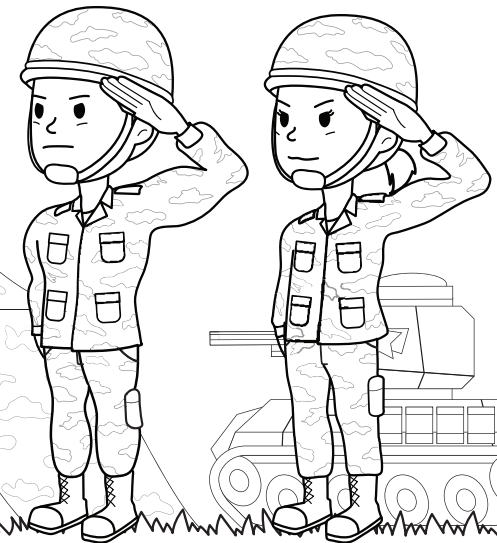
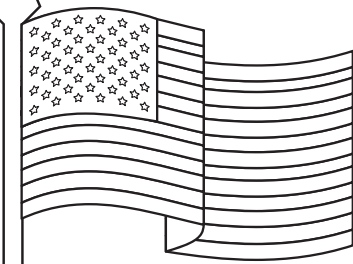

Independence Day Worksheet

1. What day is Independence Day? July 4th
2. What Year did America declare independence? 1776
3. Who was the first President? George Washington
4. How many original colonies were there? 13
5. What is the capital city in the USA? Washington D.C.

Draw the flag of 1776.

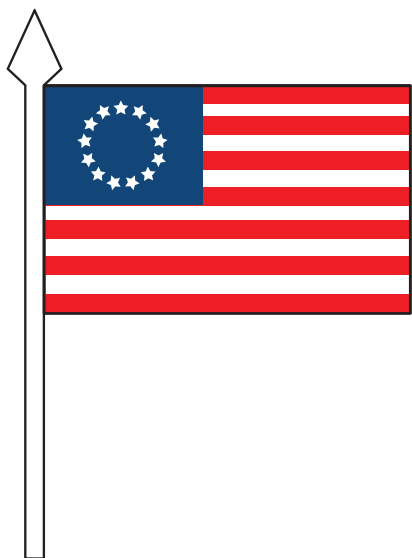

6. The stars represent : The States
7. The stripes represent : The original 13 colonies.
8. What do the following represent?
Red : Valor
White : Liberty and Purity
Blue : Justice and Loyalty
9. What does the flag represent? Independence
10. Once a flag is unrepairable you must :
Destroy it (Fire)

Define Pledge of Allegiance Terms

- Allegiance : Allegiance is loyalty to a group of cause.
- Flag : A symbol or marker showing our independence.
- Republic : A state in which the power is held by the people and the representatives they put in power.
- Nation : A large group of people that live in a country together united by history, culture, and language.
- Indivisible : Cannot be divided.
- Liberty : The ability to be free from oppressive views.
- Justice : A fairness for punishment according to the crime not status.

Pledge of Allegiance

I pledge allegiance
to the flag of the
United States of
America, and to the
Republic for which it
stands, one Nation
under God,
indivisible, with
liberty and justice
for all.

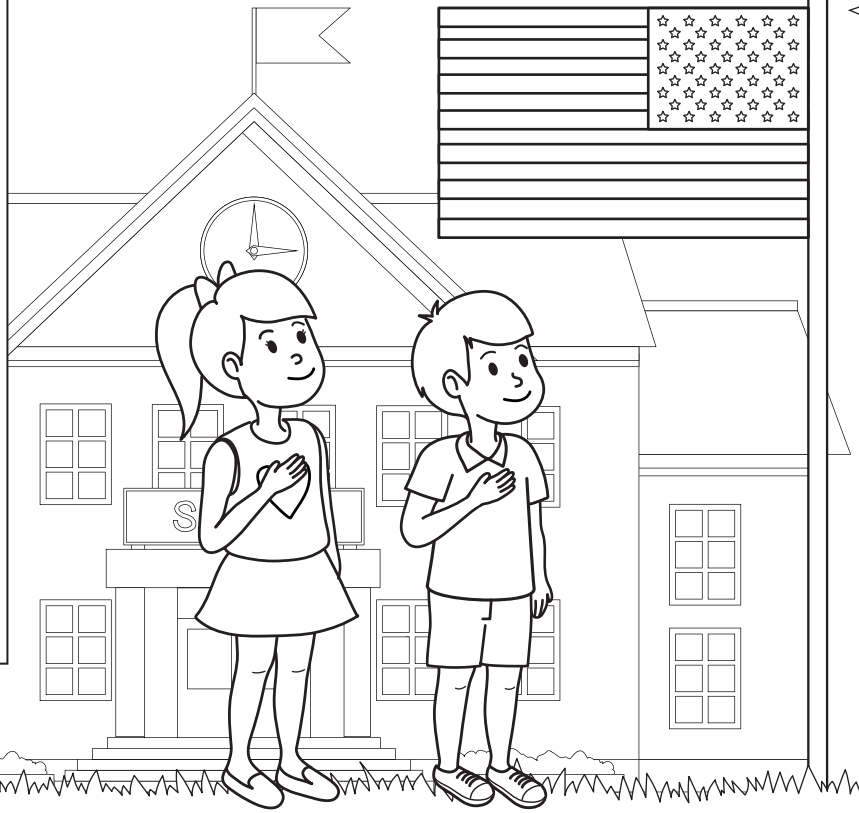

Match the following terms with the correct definitions

- | | | |
|-------------|---|---|
| Allegiance | • | Cannot be divided. |
| Flag | • | A state in which the power is held by the people and the representatives they put in power. |
| Republic | • | Loyalty to a group of cause. |
| Nation | • | The ability to be free from oppressive views. |
| Indivisible | • | A large group of people that live in a country together united by history, culture, and language. |
| Liberty | • | A symbol or marker showing our independence. |
| Justice | • | A fairness for punishment according to the crime not status. |