

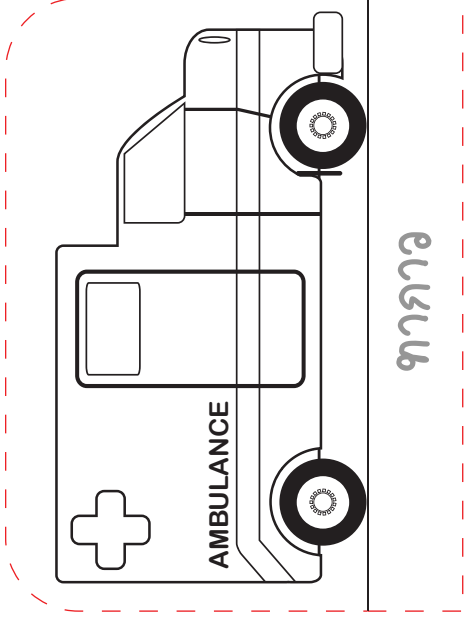

ຫາກາວ

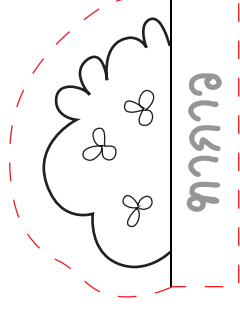

ຫາກາວ

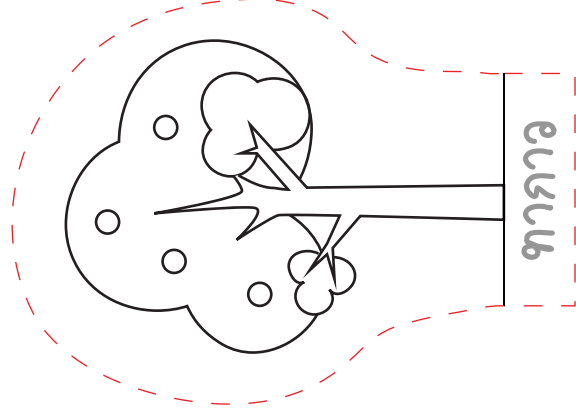
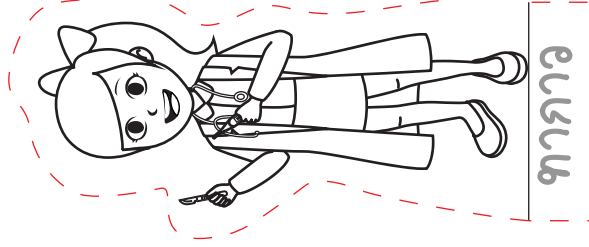
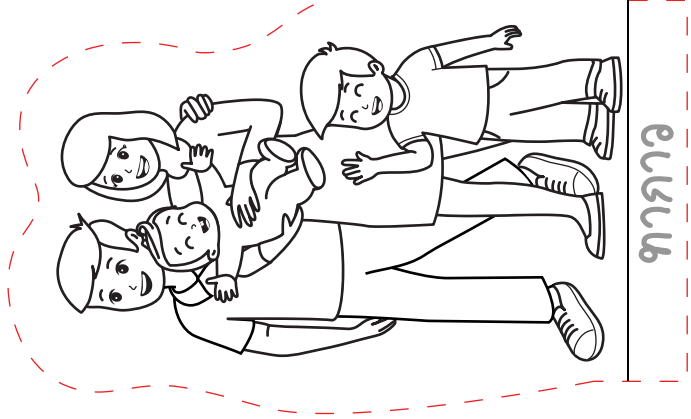
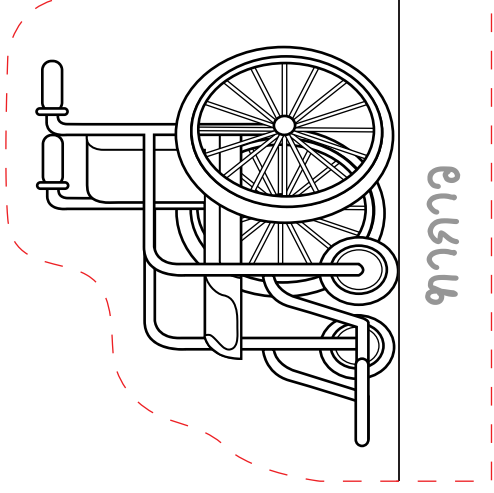

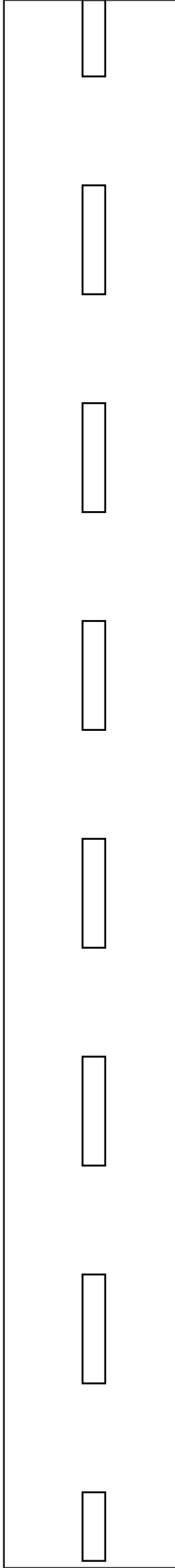
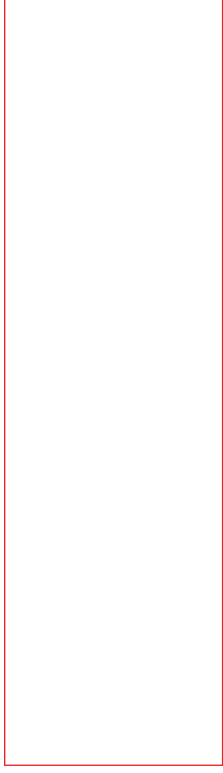
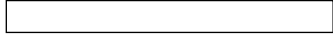

At the hospital doctor _____
is on duty _____

Patient Symptoms

Problems

- Runny Nose
- Sneezing
- Stomach ache
- Coughing
- Fever
- Ear ache
- Head ache
- Arm hurt
- Leg hurt

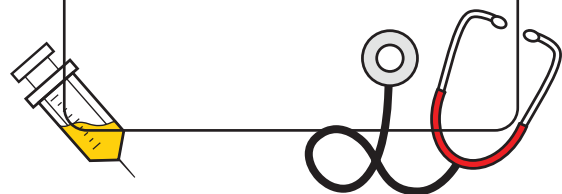
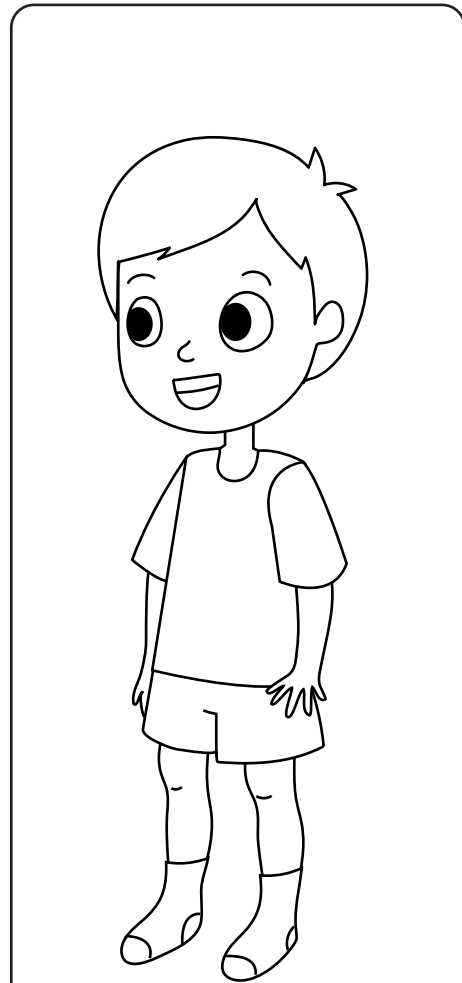

Diagnosis _____

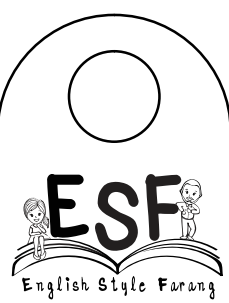

Patient Information

Patient's name

Allergies

Temperature

	Good	Injured
Eyes	<input type="checkbox"/>	<input type="checkbox"/>
Ears	<input type="checkbox"/>	<input type="checkbox"/>
Nose	<input type="checkbox"/>	<input type="checkbox"/>
Head	<input type="checkbox"/>	<input type="checkbox"/>
Arms	<input type="checkbox"/>	<input type="checkbox"/>
Legs	<input type="checkbox"/>	<input type="checkbox"/>

Notes _____

Completed by doctor _____

Word Search



E T T P I H C B P T E Q R I R E M O I H
Z G W A I Y P S E L E Z P U E O T R T I
Y V N D O B R K Y N W B P X M Q G A Y X
P S C I A C A L E P L A C S M V R K S C
W D Y J R R Y N B I C A O K A G J J X M
B I Z O E Y M R D I A D L B H J C X U X
F N N O H W S B O A F Q A G X A I W E I
N B O I A D U Q J T G S S H E S E X W L
N J E T J D R K E G A E O D L E G A S E
T H E R M O M E T E R R S U F L O X P Z
V V D L A L T I P J H W O N E E I O Q Z
X D S K V Z L R Y L E Q C B R B C F Y Y
H K B U N O J V P F Z M J W A S G H O M
F F U C E R U S S E R P D O O L B T Q E
G U S G W Y M M V D V U Z H R L O O F D
U F I Y U P C D V Y D F T J G S Q M K I
E D O Q C Q M B T J M E P T C T M H Q C
K S K D P K B M W W T X F O Z A H A Z I
S G E Q S I R C U S E F P Q Y O Y B A N
R V V O R A W Y L N J E N M G B L I C E



BANDAGES

BLOOD PRESSURE CUFF

LABORATORY COAT

MEDICINE

OTOSCOPE

REFLEX HAMMER

SCALPEL

STETHOSCOPE

SYRINGE

THERMOMETER



English Style Farang

www.esfworksheets.com

My Tools

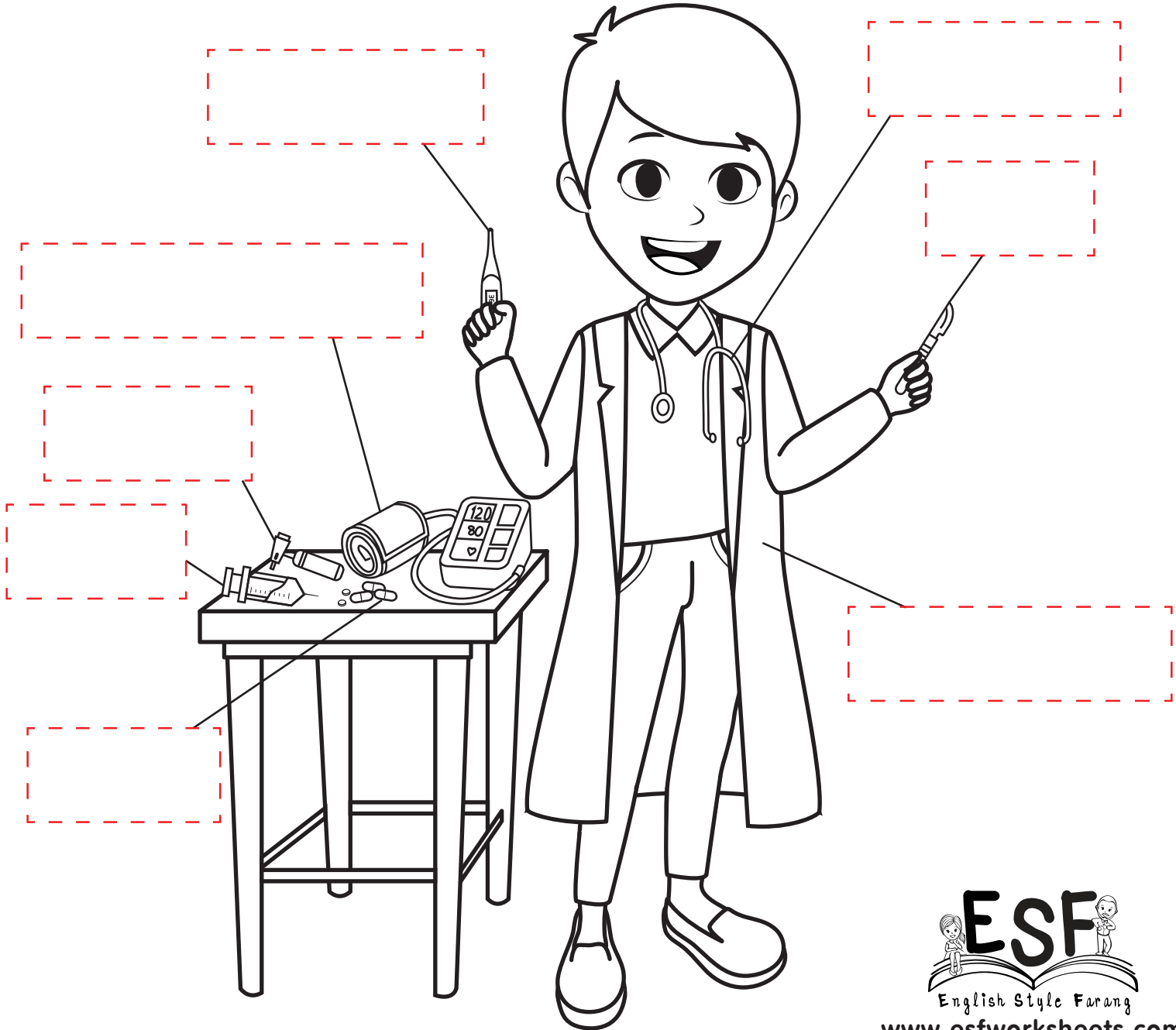

English Style Farang

www.esfworksheets.com

© 2020 All Right Reserved

Thermometer | Blood Pressure Cuff | Syringe | Scalpel

Laboratory Coat | Medicine | Otoscope | Stethoscope

Medical Equipment Matching

Stethoscope

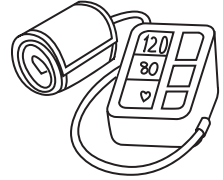

Scalpel

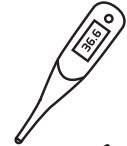

Syringe



Thermometer

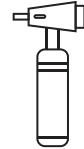

Bandages



Blood Pressure Cuff



Medicine



Reflex hammer

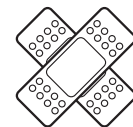

Otoscope



Laboratory Coat



English Style Farang

www.esfworksheets.com

© 2020 All Right Reserved

If I were a doctor.

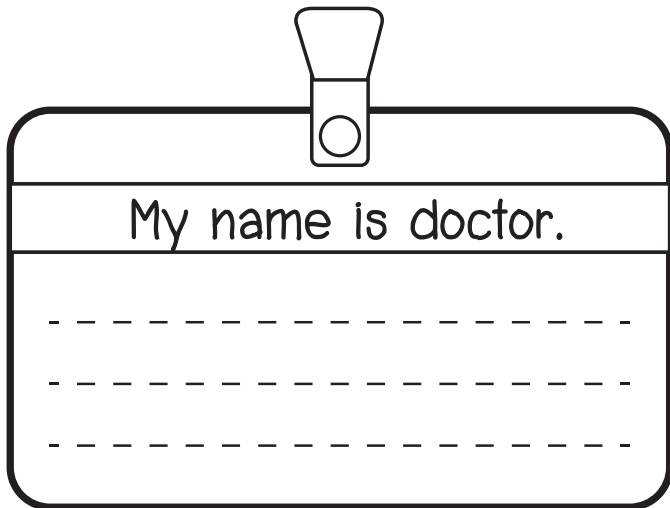

My name is doctor.

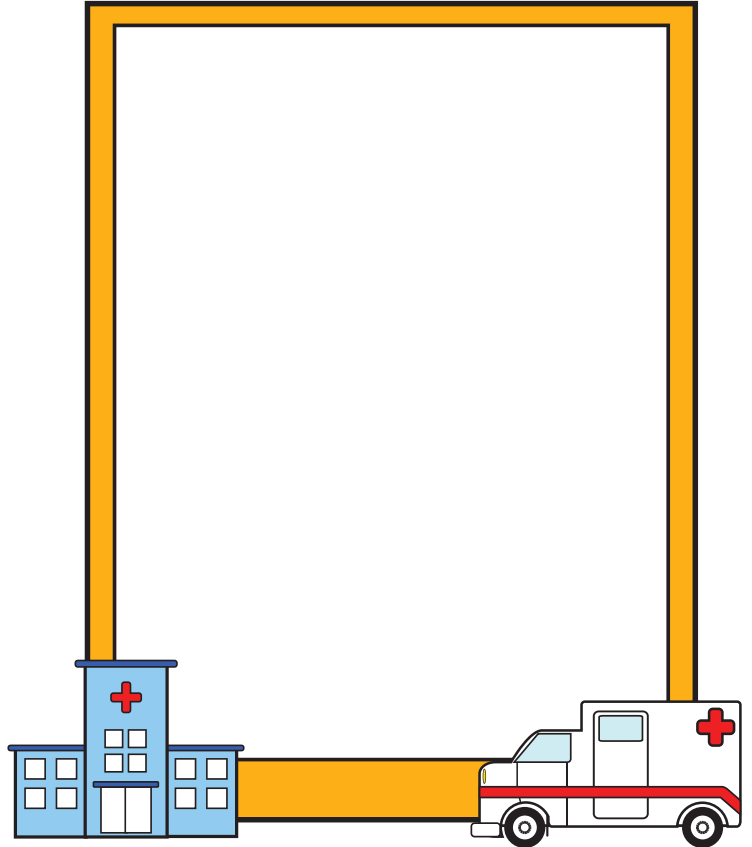

I would like to _____

When someone is sick I would _____



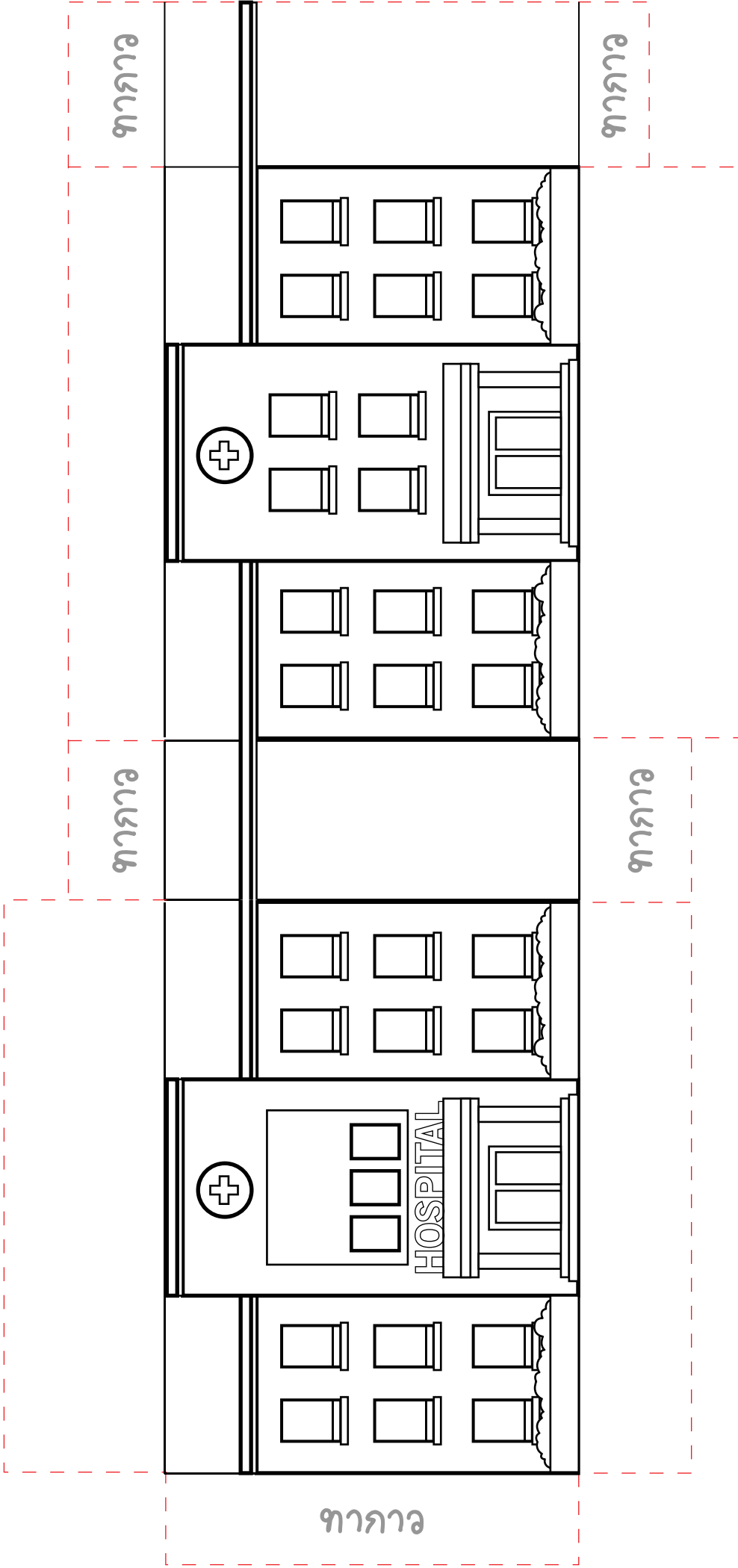

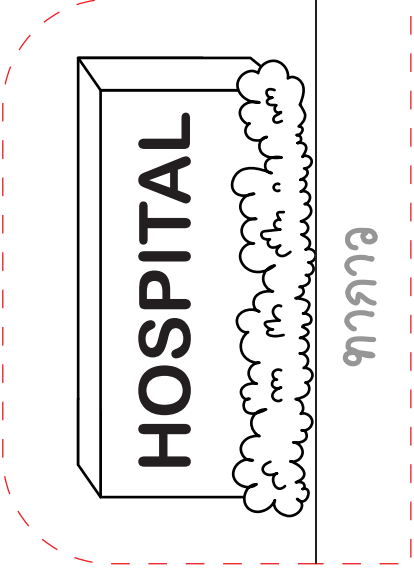

ຫາກາວ

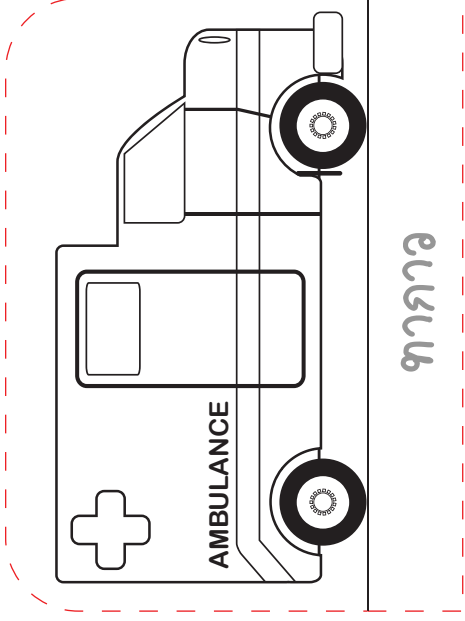

ຫາກາວ

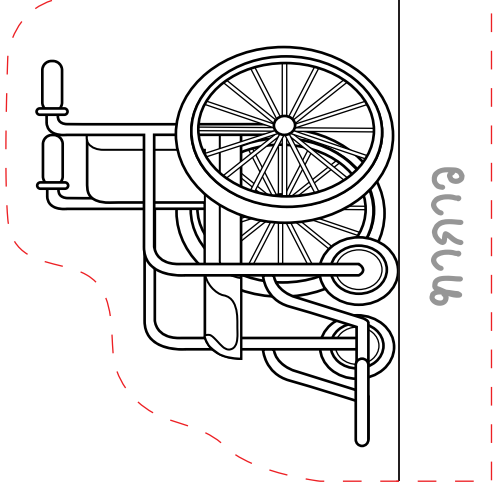

ຫາກາວ

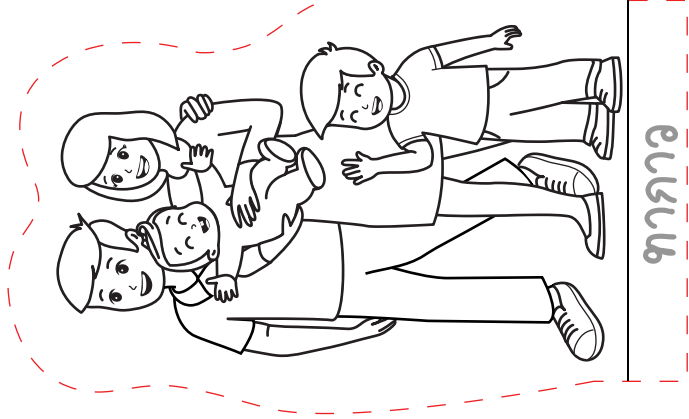

ຫາກາວ

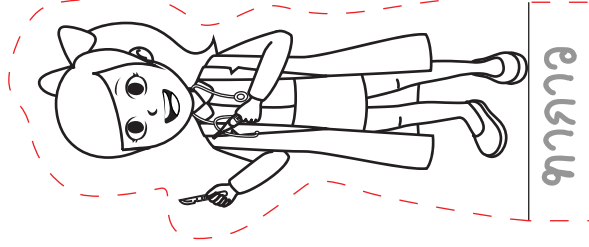

ຫາກາວ



ຫາກາວ

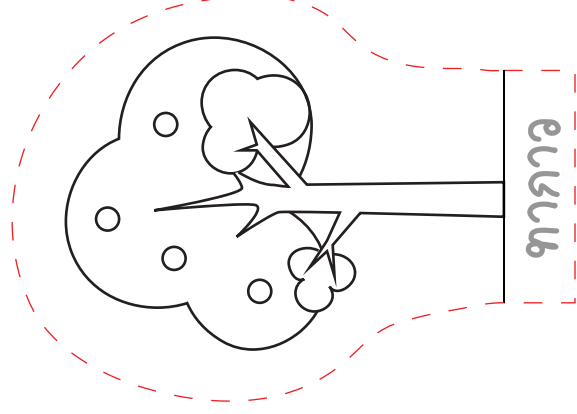

ຫາກາວ

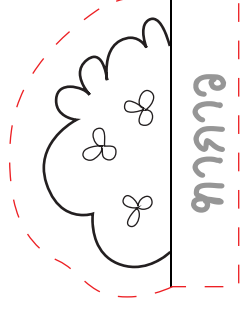

ຫາກາວ

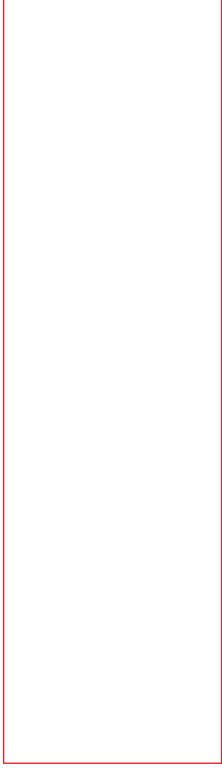
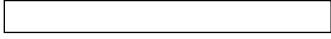

A series of ten small horizontal rectangular boxes arranged in a row, intended for writing individual words or characters.

At the hospital doctor _____
is on duty _____

Patient Symptoms

Problems

- Runny Nose
- Sneezing
- Stomach ache
- Coughing
- Fever
- Ear ache
- Head ache
- Arm hurt
- Leg hurt

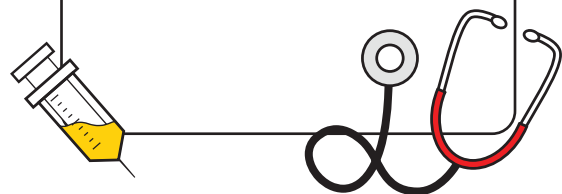
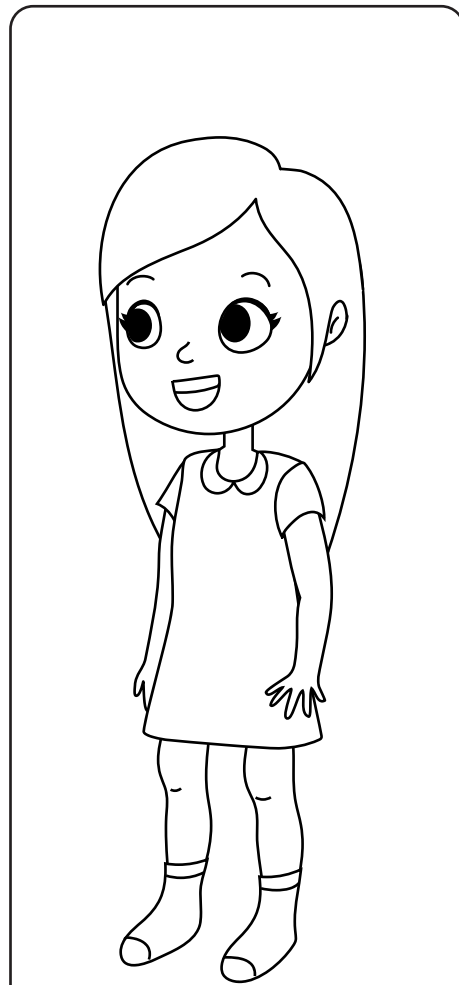

Diagnosis _____



www.esfworksheets.com

Patient Information

Patient's name

Allergies

Temperature

	Good	Injured
Eyes	<input type="checkbox"/>	<input type="checkbox"/>
Ears	<input type="checkbox"/>	<input type="checkbox"/>
Nose	<input type="checkbox"/>	<input type="checkbox"/>
Head	<input type="checkbox"/>	<input type="checkbox"/>
Arms	<input type="checkbox"/>	<input type="checkbox"/>
Legs	<input type="checkbox"/>	<input type="checkbox"/>

Notes _____

Completed by doctor _____

Word Search



E T T P I H C B P T E Q R I R E M O I H
Z G W A I Y P S E L E Z P U E O T R T I
Y V N D O B R K Y N W B P X M Q G A Y X
P S C I A C A L E P L A C S M V R K S C
W D Y J R R Y N B I C A O K A G J J X M
B I Z O E Y M R D I A D L B H J C X U X
F N N O H W S B O A F Q A G X A I W E I
N B O I A D U Q J T G S S H E S E X W L
N J E T J D R K E G A E O D L E G A S E
T H E R M O M E T E R R S U F L O X P Z
V V D L A L T I P J H W O N E E I O Q Z
X D S K V Z L R Y L E Q C B R B C F Y Y
H K B U N O J V P F Z M J W A S G H O M
F F U C E R U S S E R P D O O L B T Q E
G U S G W Y M M V D V U Z H R L O O F D
U F I Y U P C D V Y D F T J G S Q M K I
E D O Q C Q M B T J M E P T C T M H Q C
K S K D P K B M W W T X F O Z A H A Z I
S G E Q S I R C U S E F P Q Y O Y B A N
R V V O R A W Y L N J E N M G B L I C E



BANDAGES

BLOOD PRESSURE CUFF

LABORATORY COAT

MEDICINE

OTOSCOPE

REFLEX HAMMER

SCALPEL

STETHOSCOPE

SYRINGE

THERMOMETER



English Style Farang

www.esfworksheets.com

My Tools

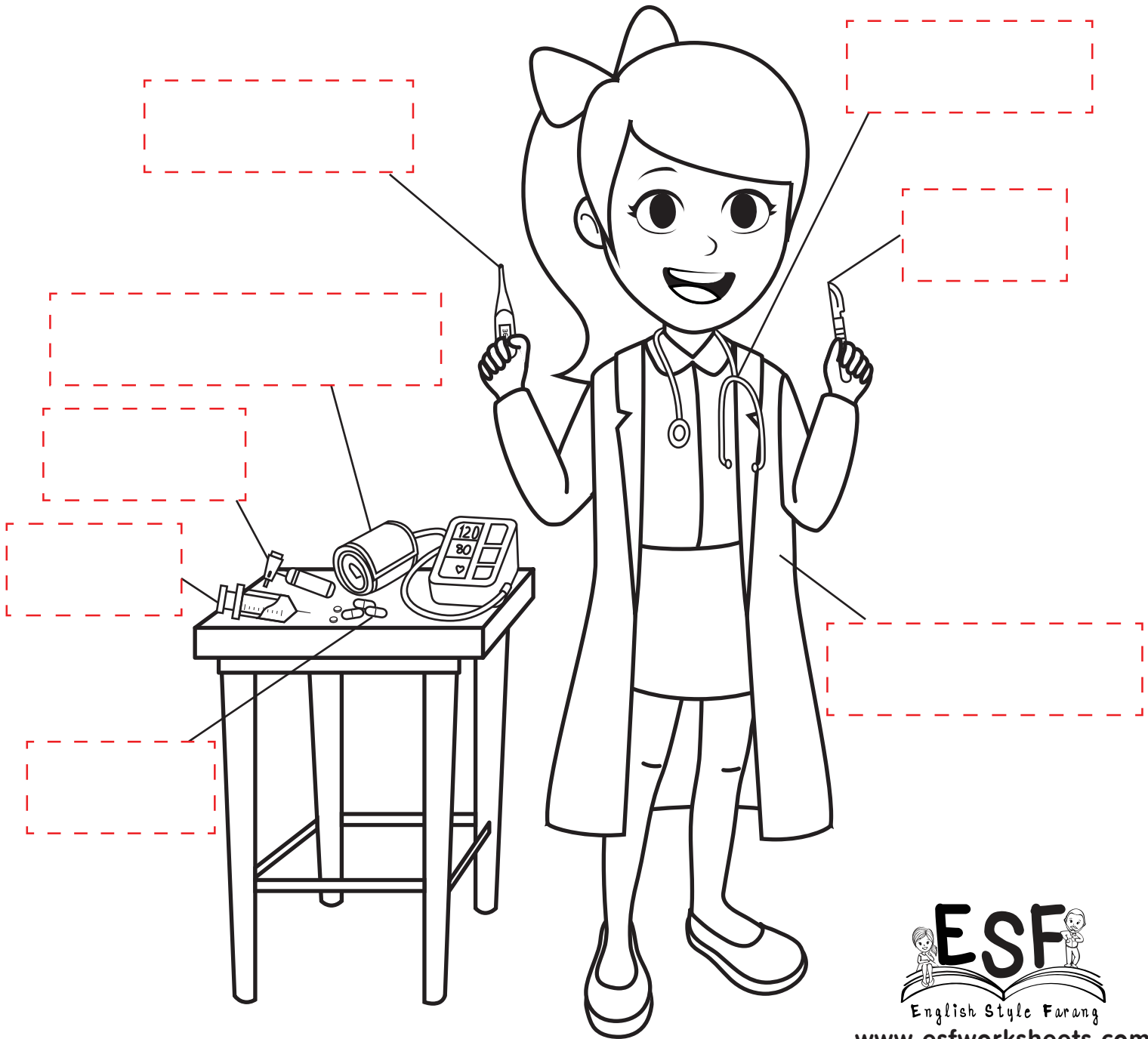

English Style Farang

www.esfworksheets.com

© 2020 All Right Reserved

Thermometer | Blood Pressure Cuff | Syringe | Scalpel

Laboratory Coat | Medicine | Otoscope | Stethoscope

Medical Equipment Matching

Stethoscope

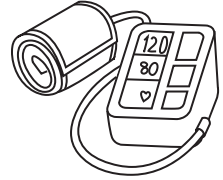

Scalpel

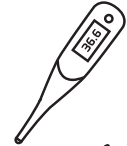

Syringe



Thermometer

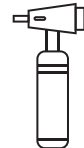

Bandages



Blood Pressure Cuff



Medicine



Reflex hammer

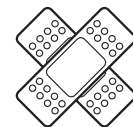

Otoscope



Laboratory Coat



English Style Farang

www.esfworksheets.com

© 2020 All Right Reserved

If I were a doctor.

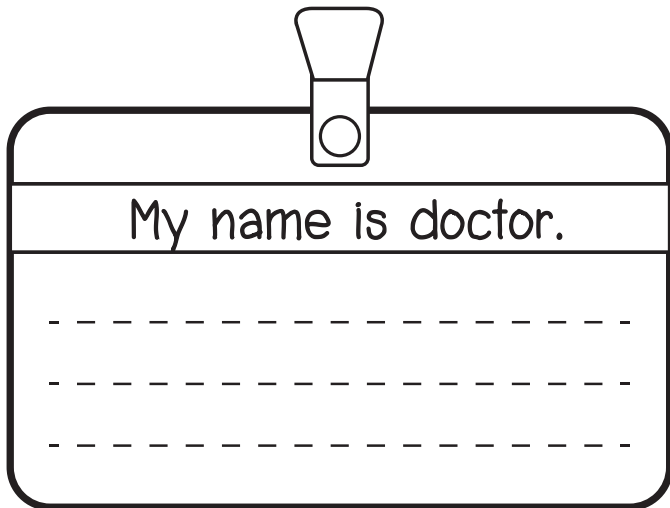

My name is doctor.

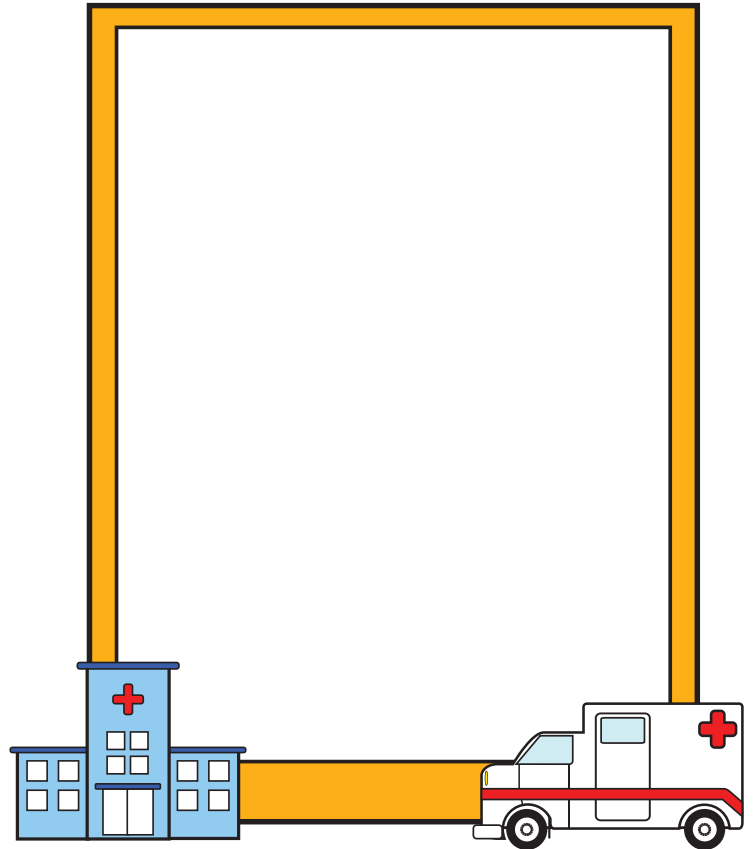

I would like to _____

When someone is sick I would _____
