

Launch Pad

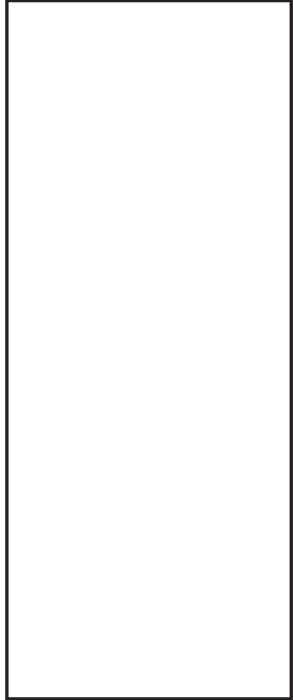

Would you like to watch a liftoff? _____

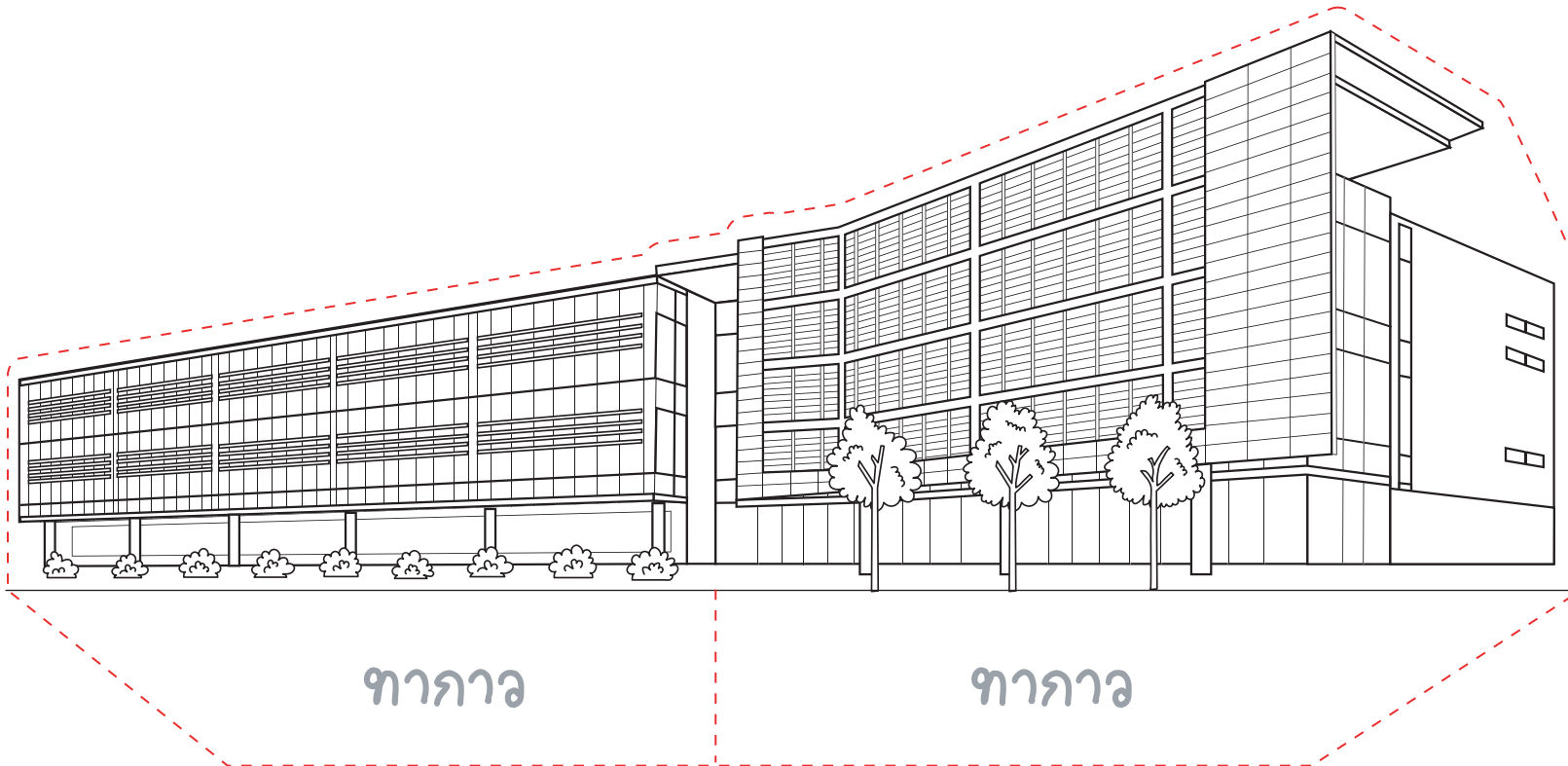

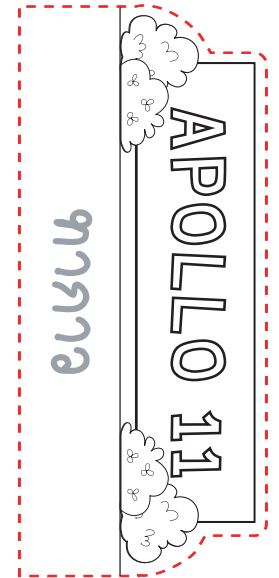
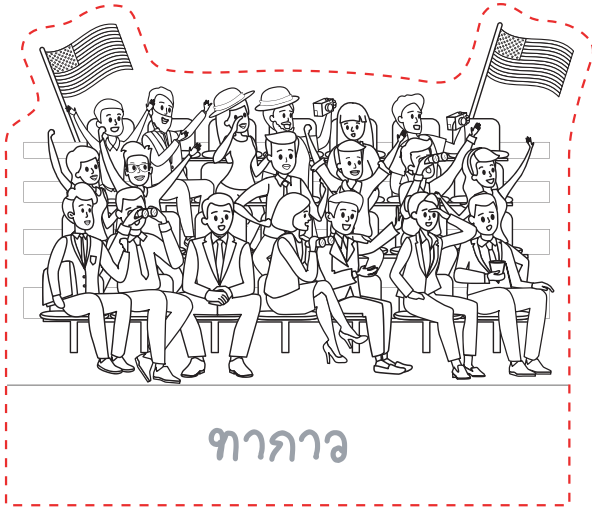
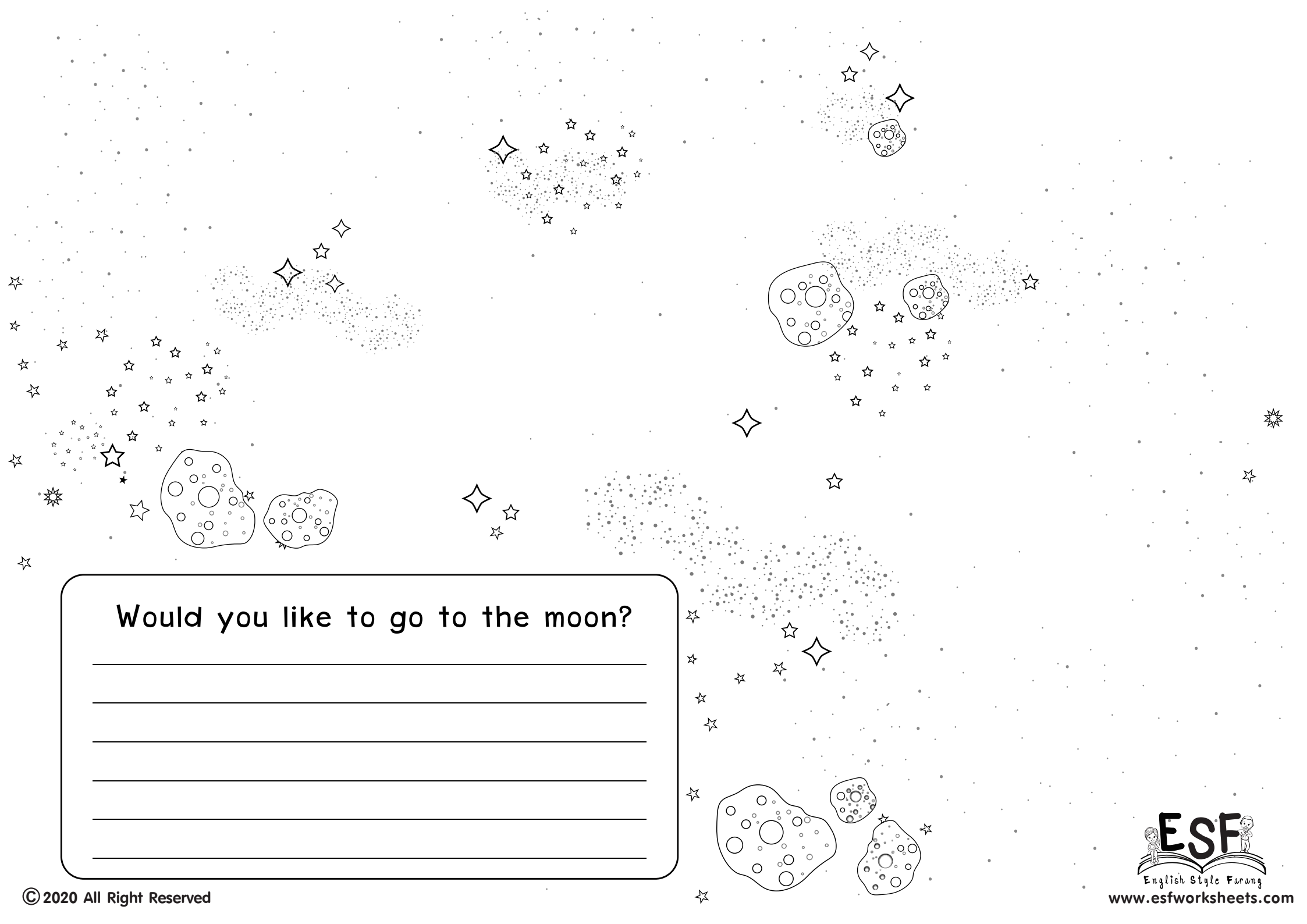

Would you like to go to the moon?

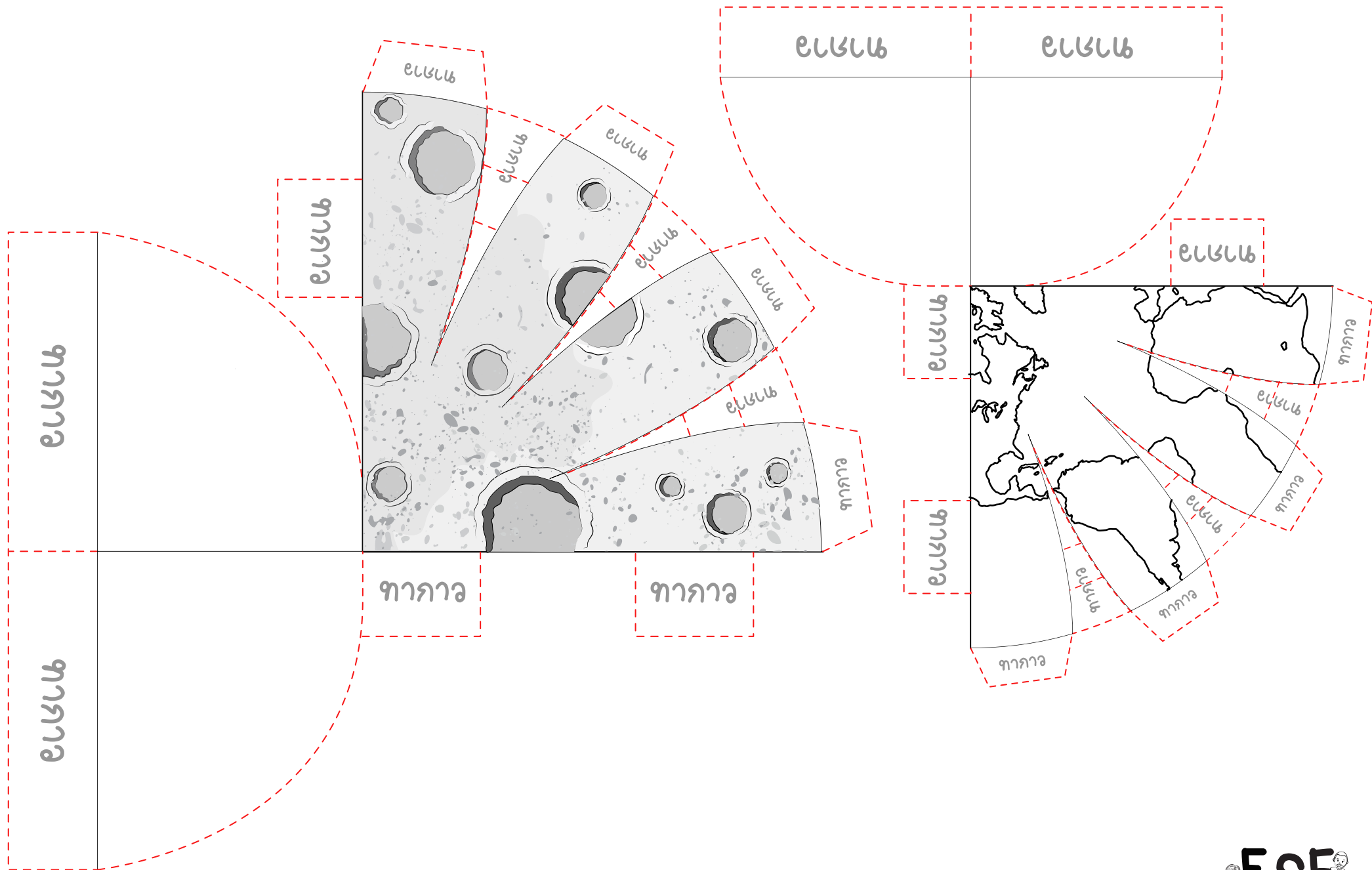

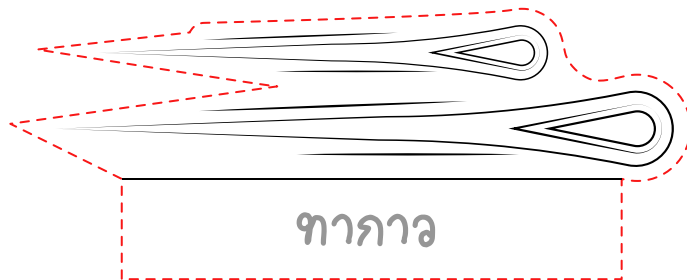
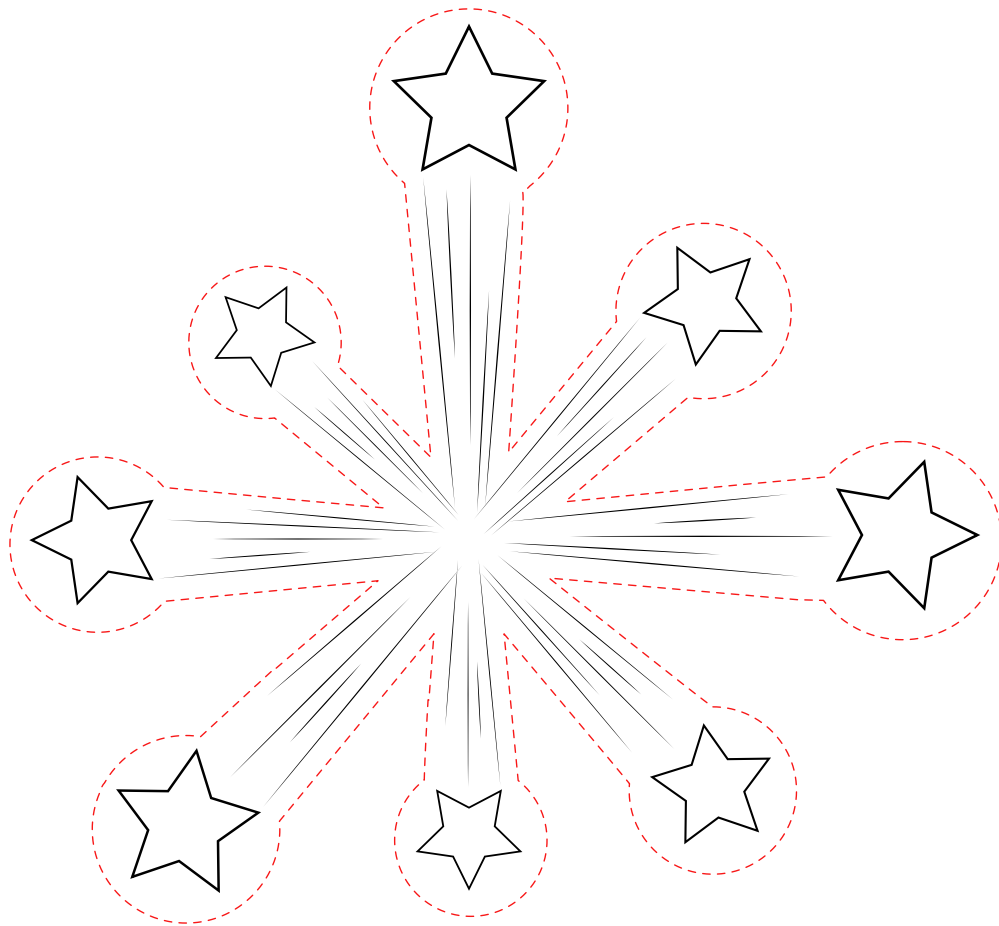

កាកា

កាកា

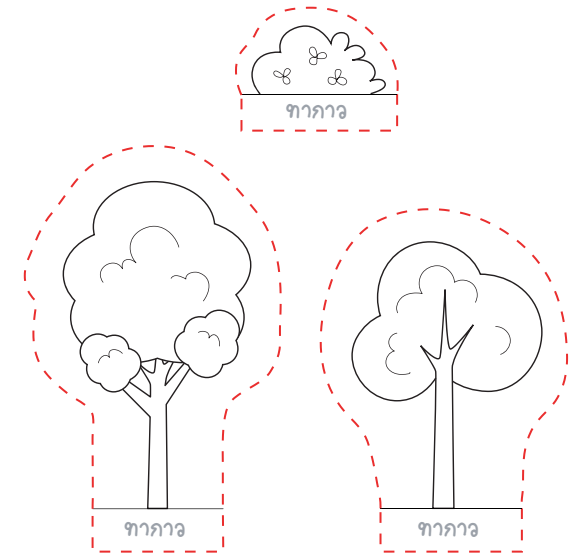
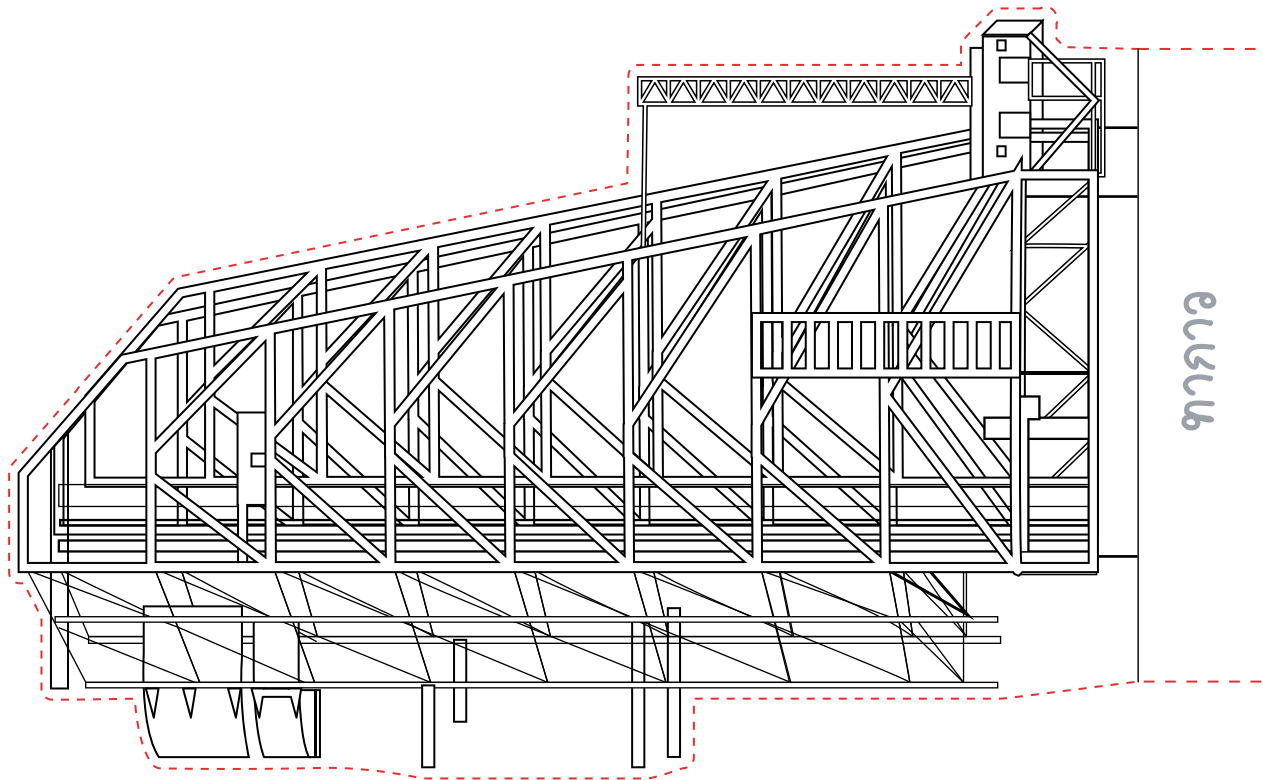
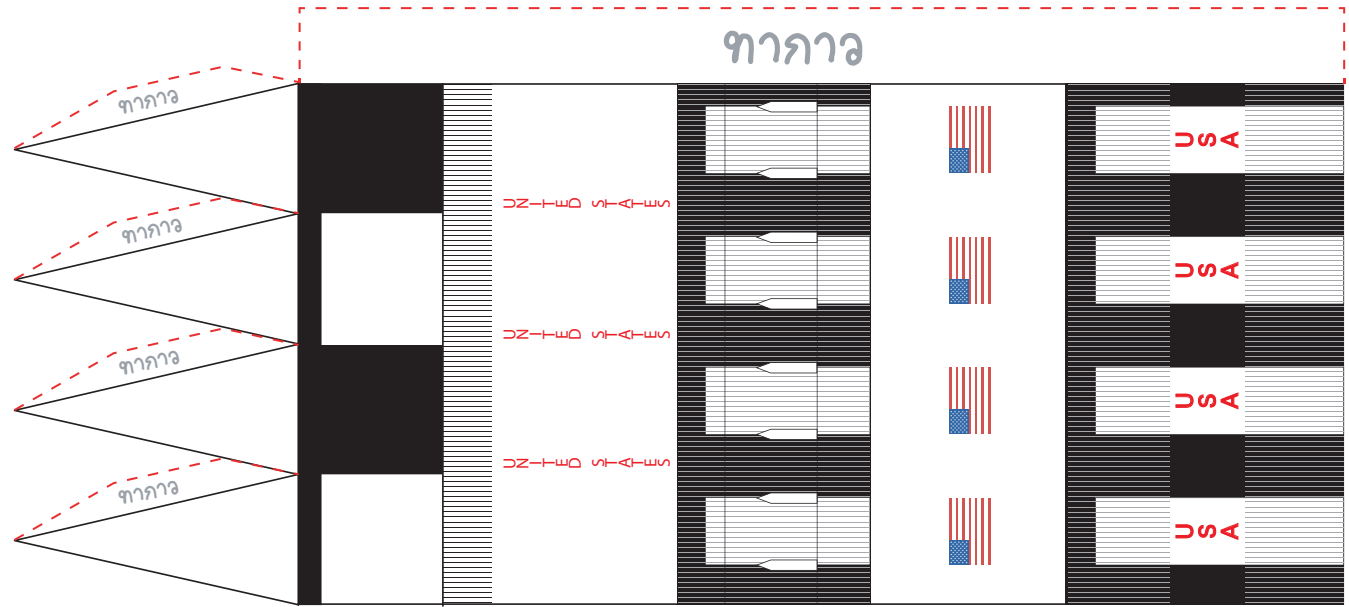
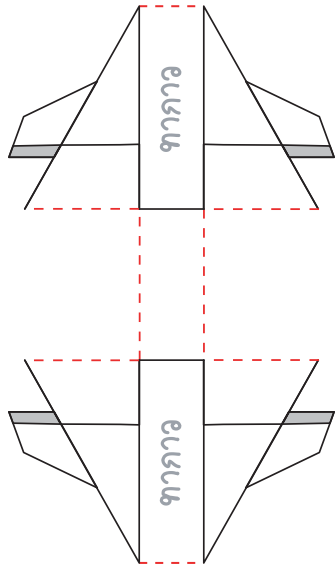

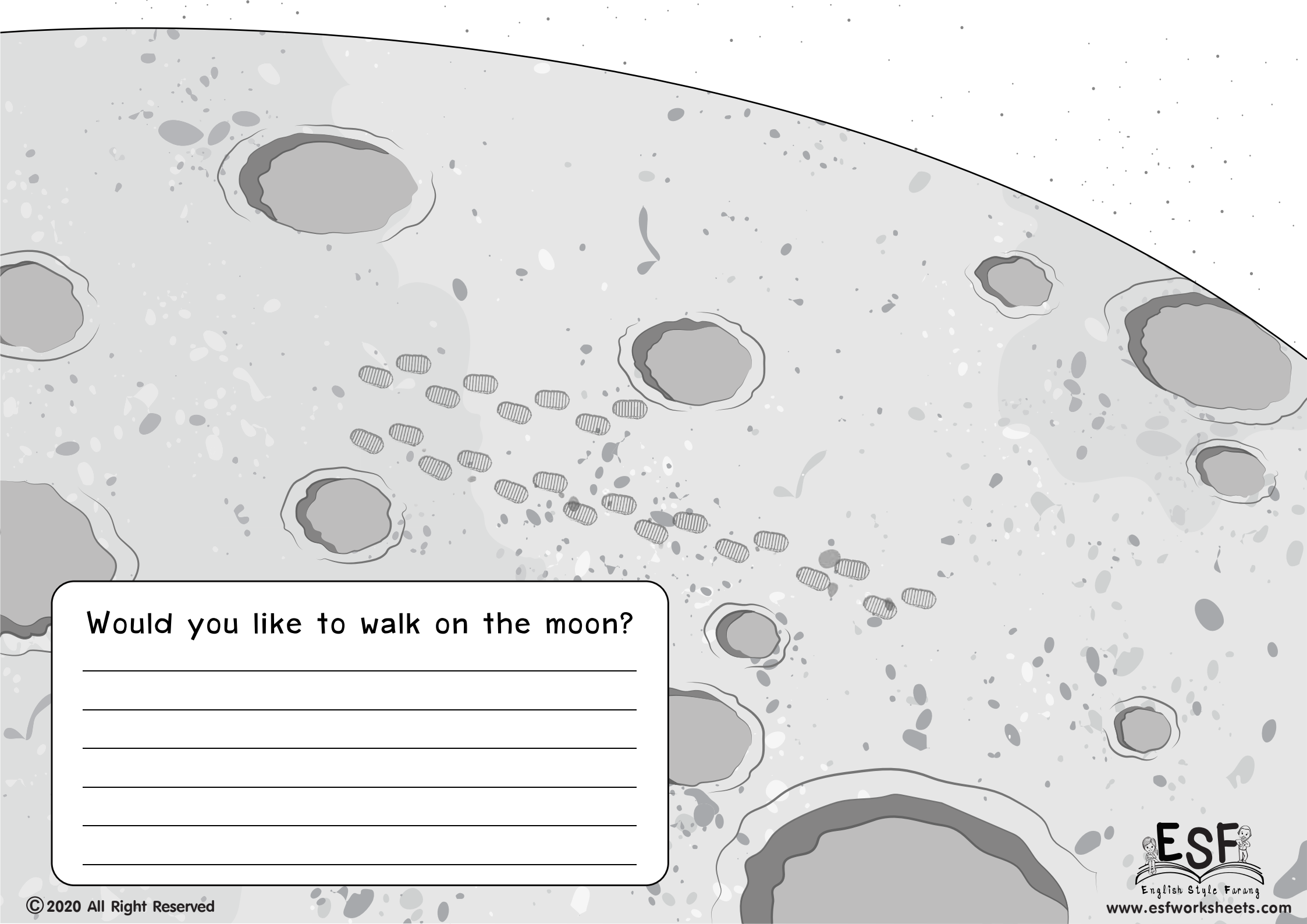

Would you like to walk on the moon?

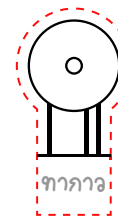
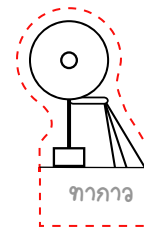
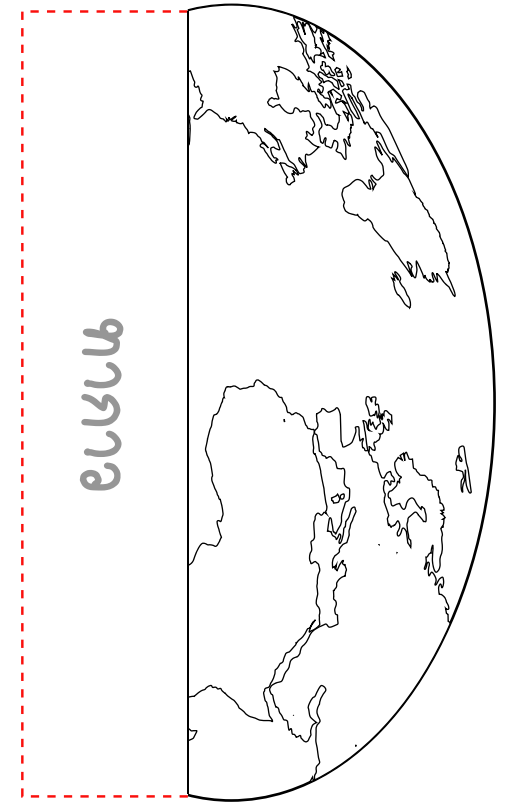
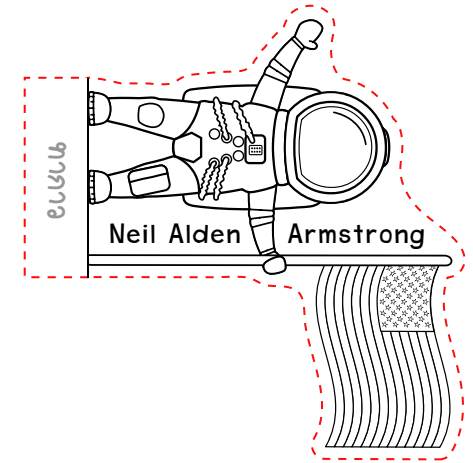
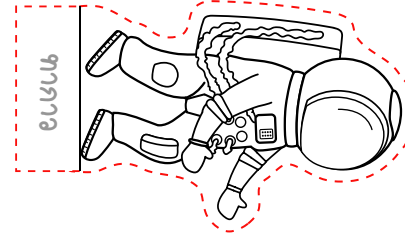
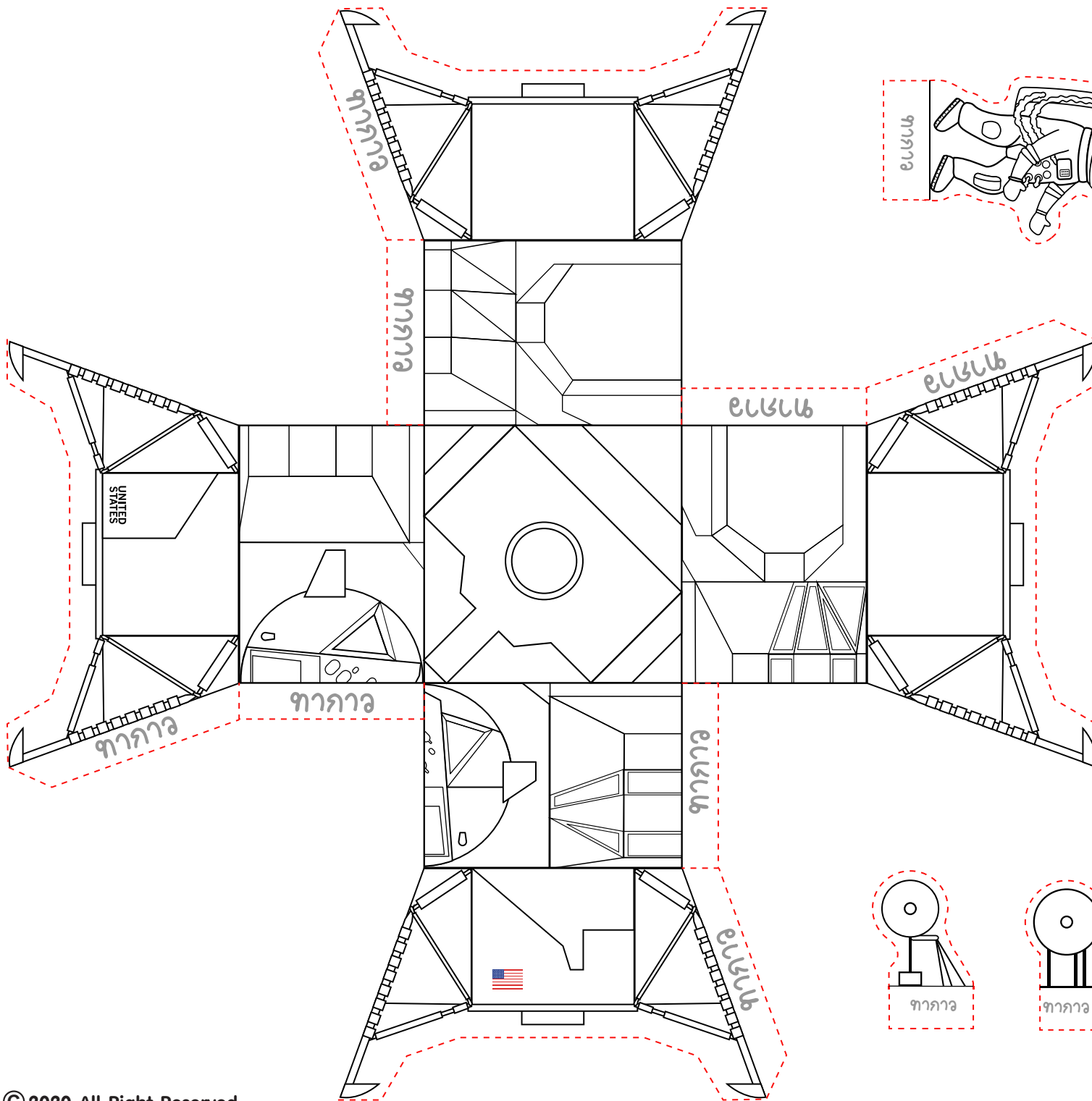

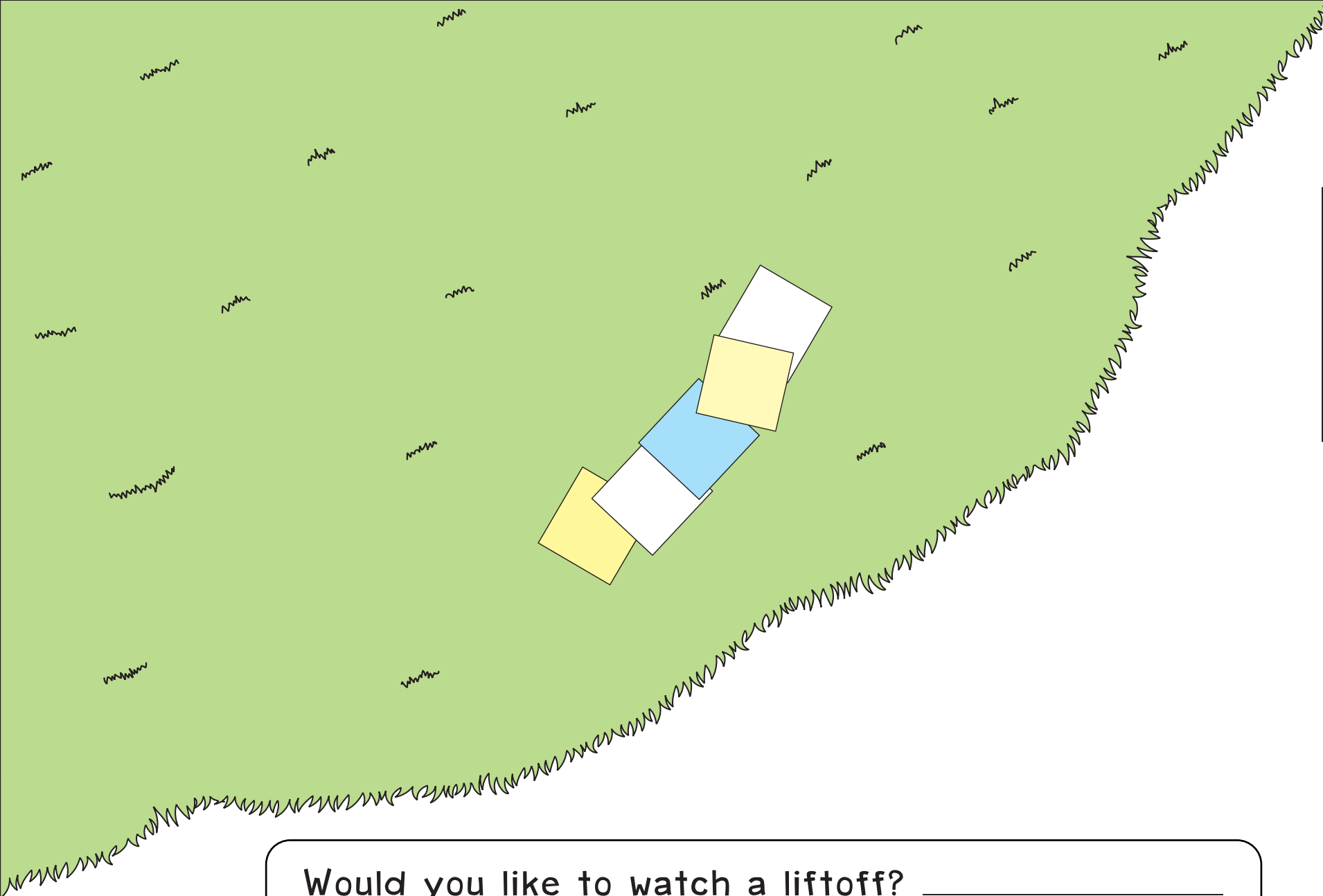

Launch Pad



Would you like to watch a liftoff? _____

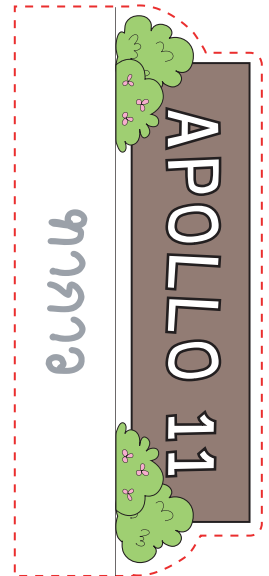
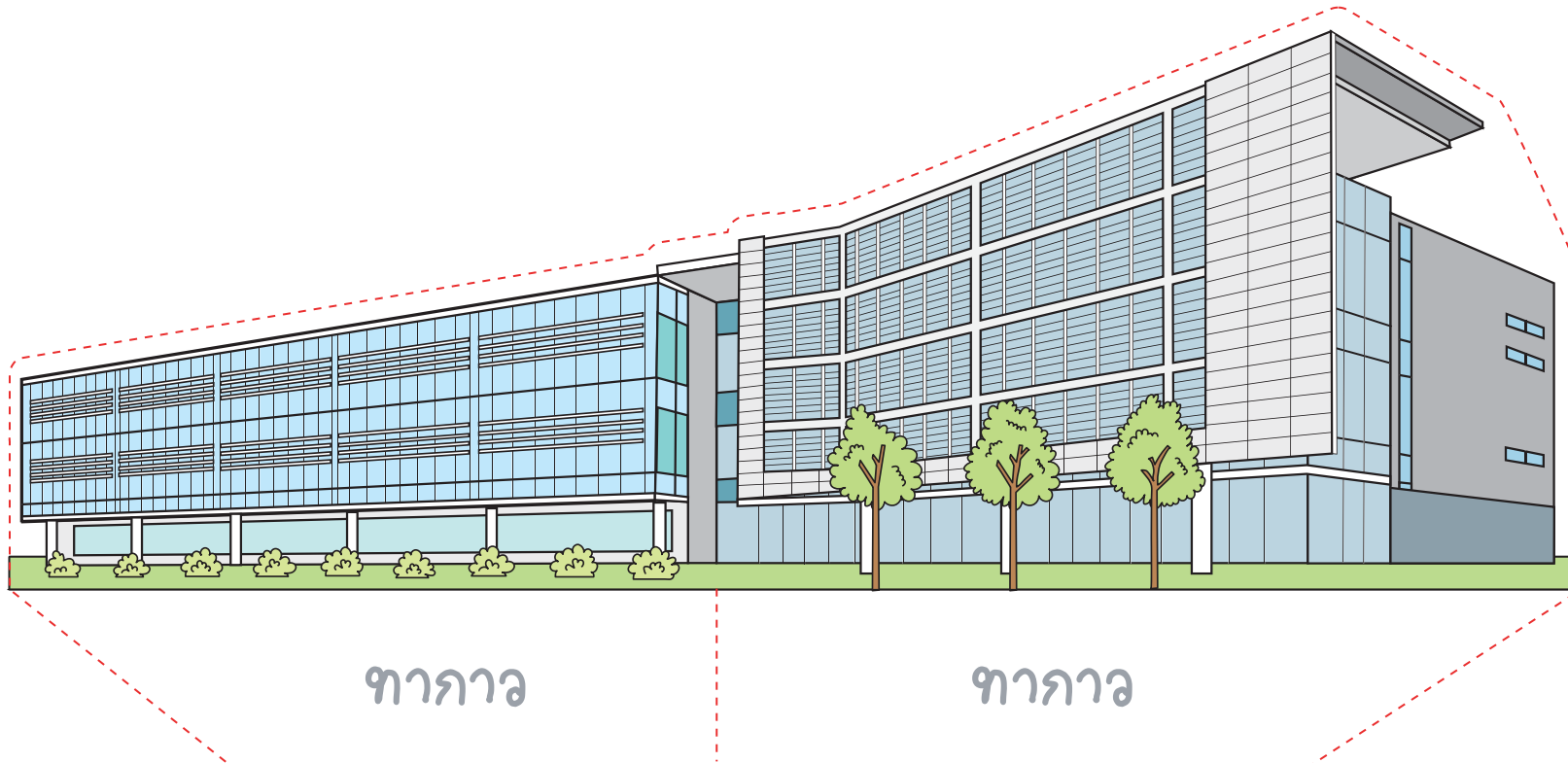

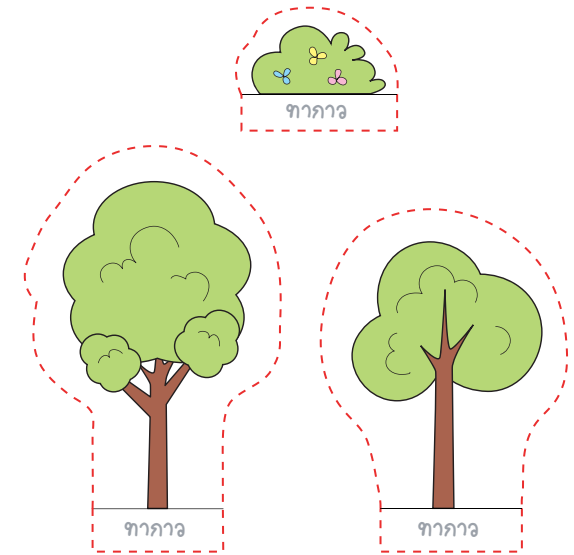
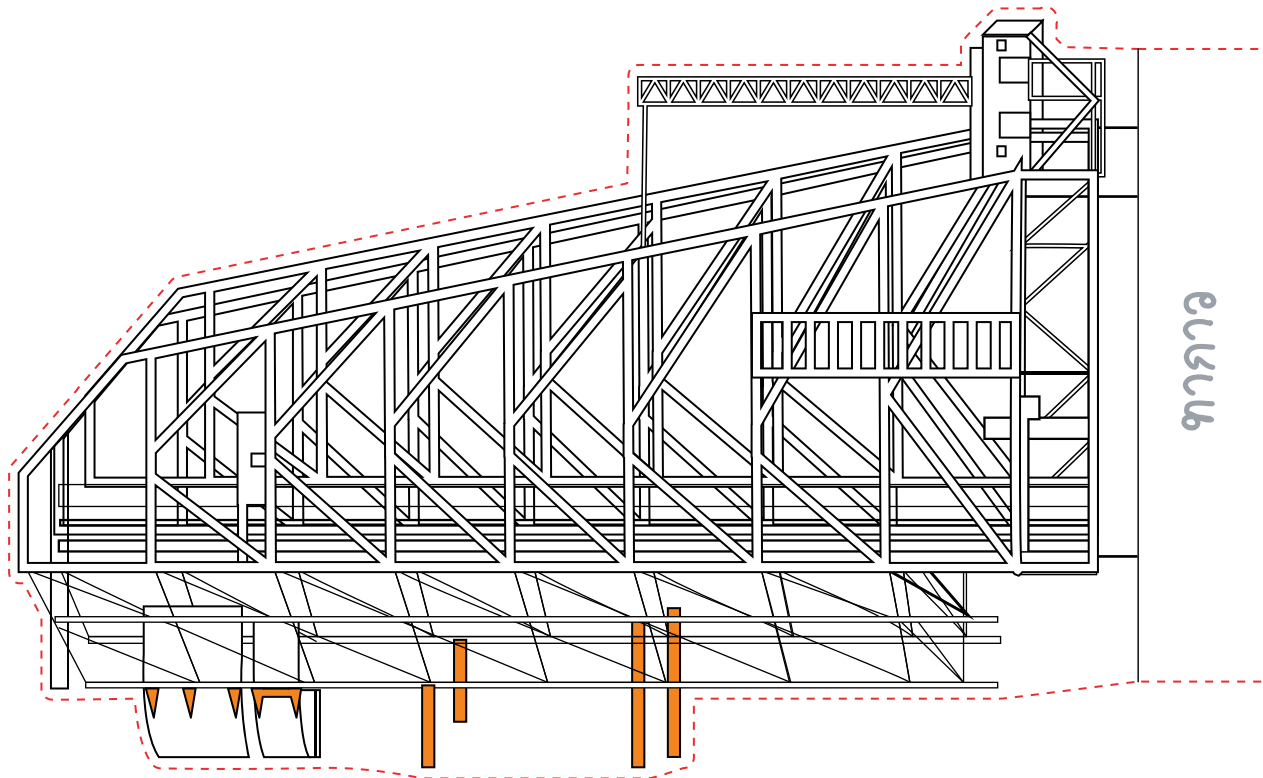
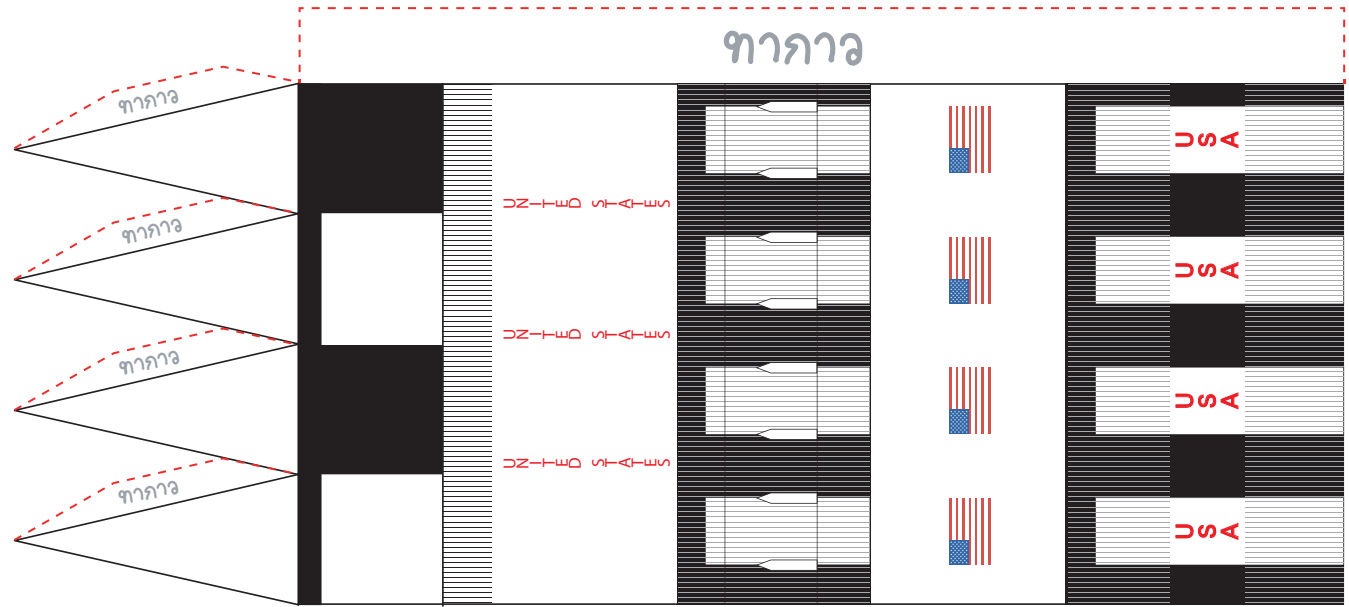
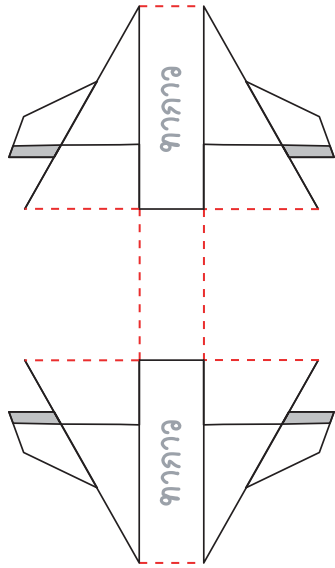



Would you like to go to the moon?

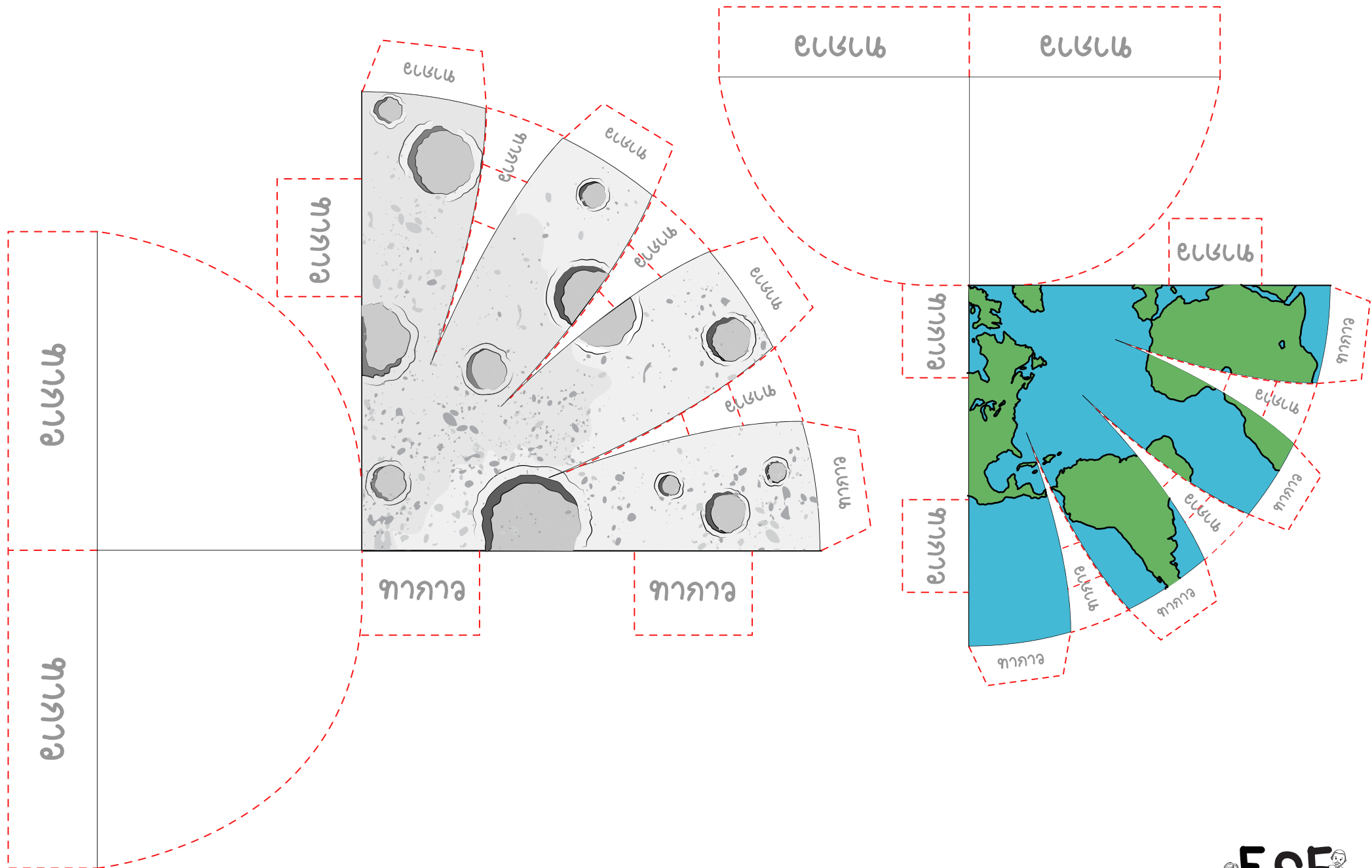

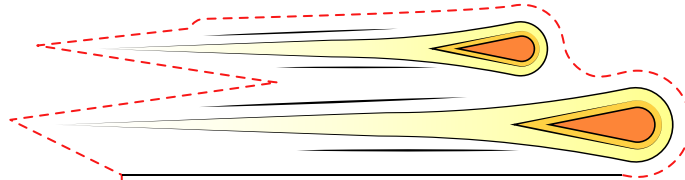
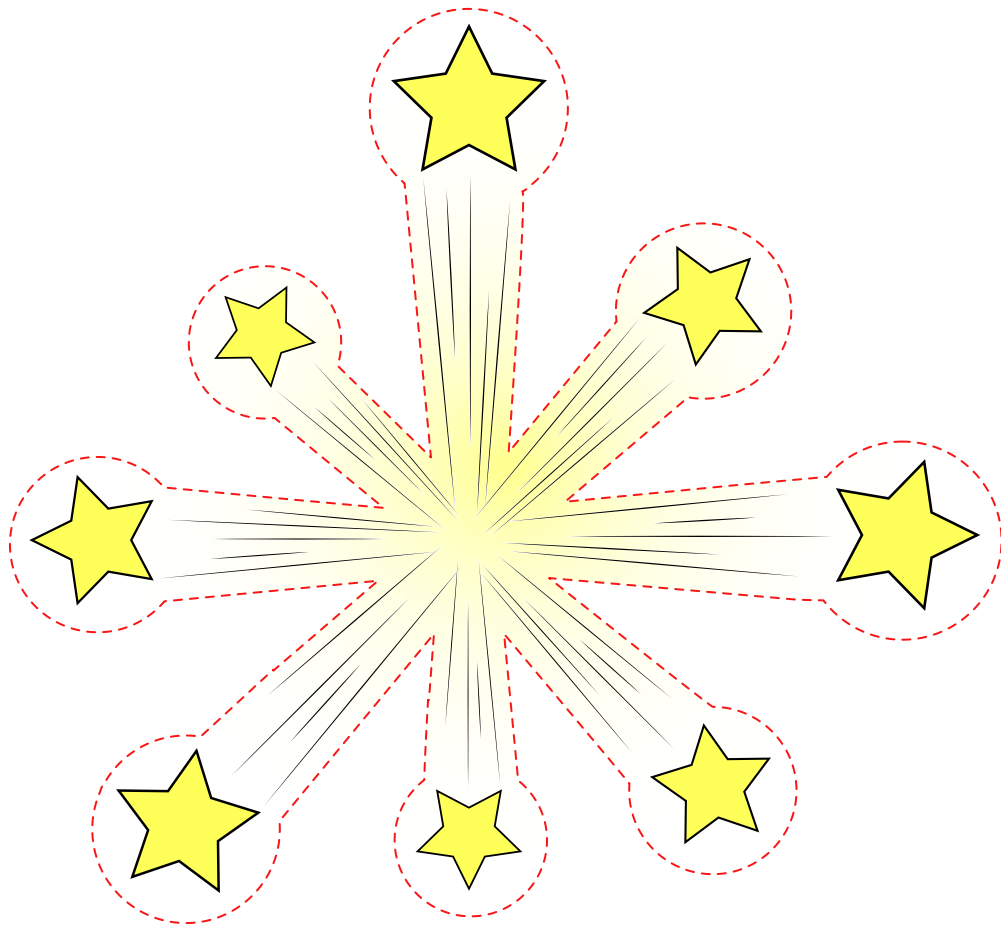

ຫາກາວ

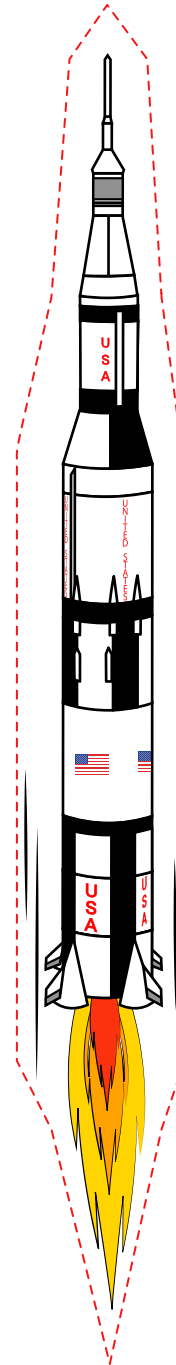

၅၇
ကက

၅၇
ကက

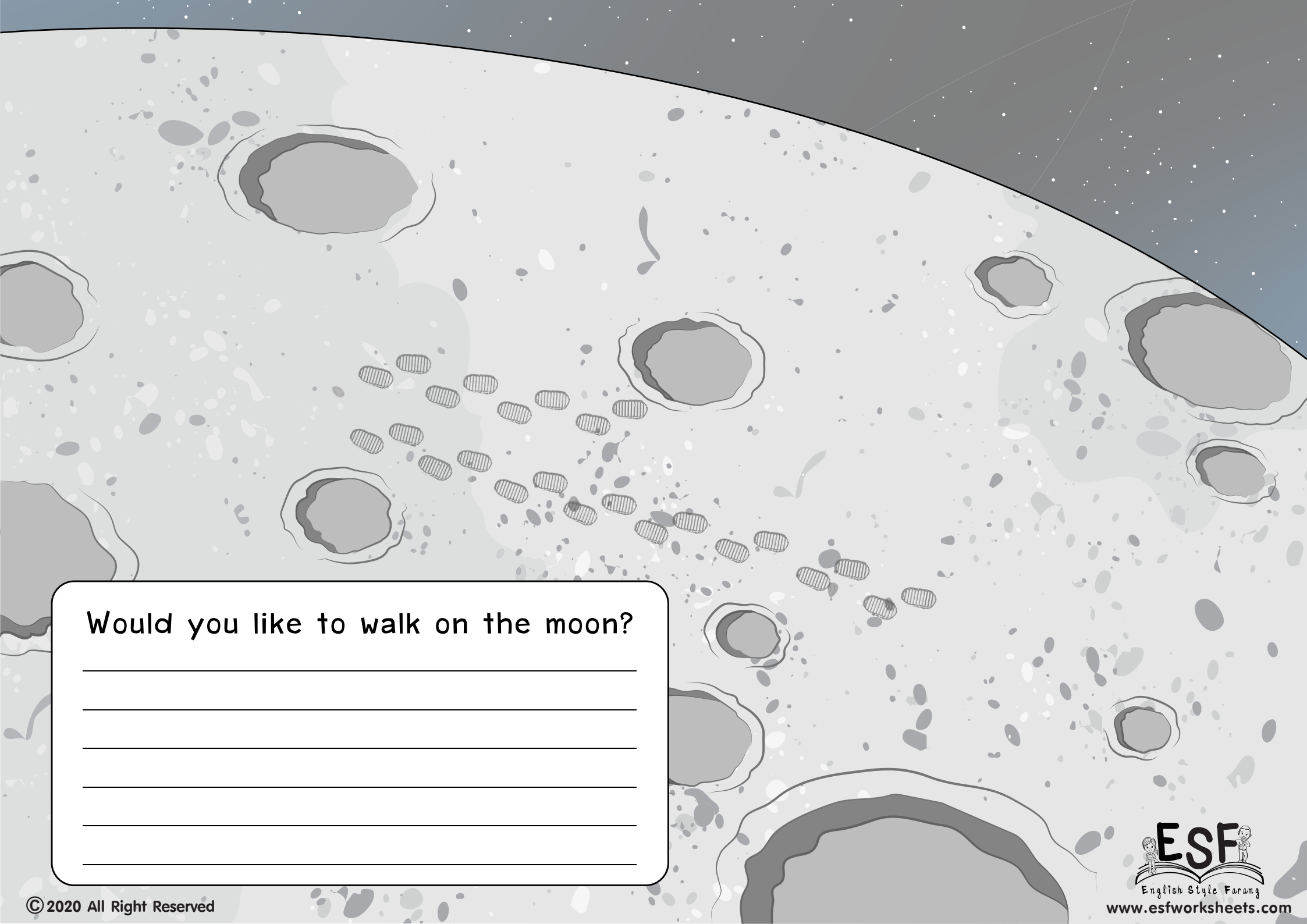

Would you like to walk on the moon?

