

Write the Preposition

ฝึกเขียนคำศัพท์

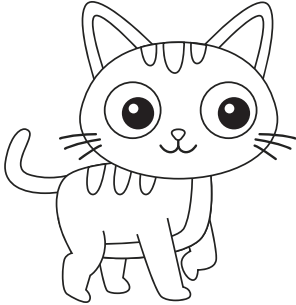

Near

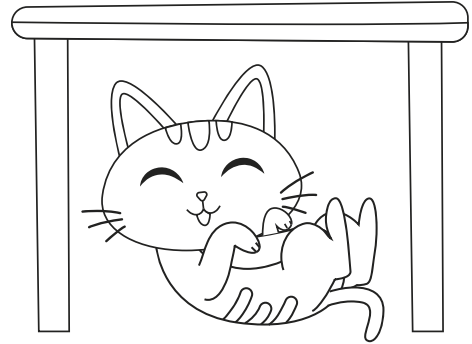

Under

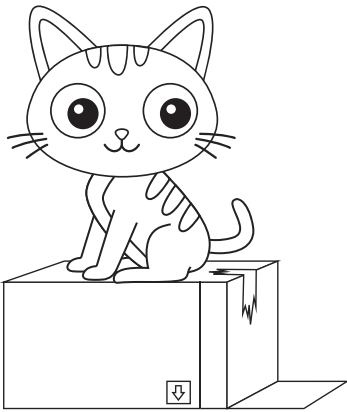

On



In

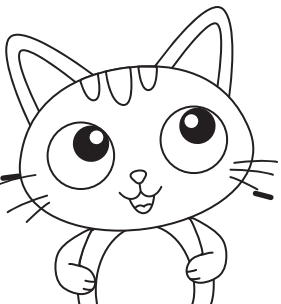

www.esfworksheets.com

© 2020 All Right Reserved

Write the Preposition

ฝึกเขียนคำศัพท์



Behind

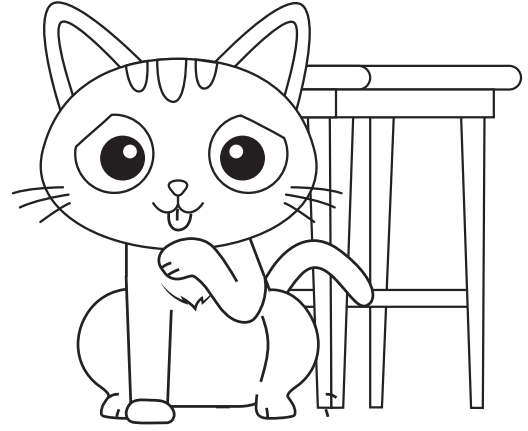

In front

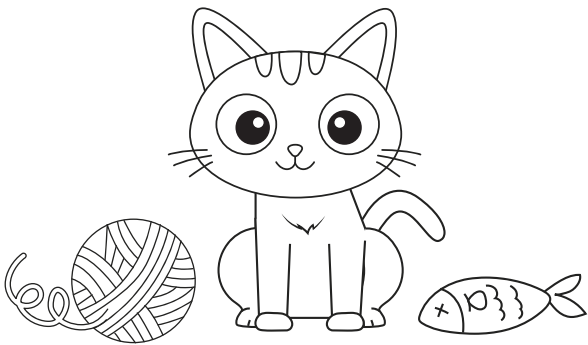

Between

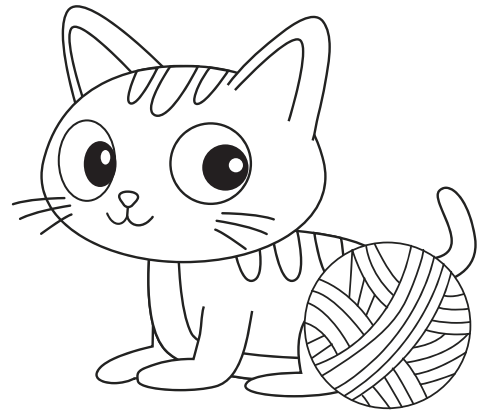

Beside

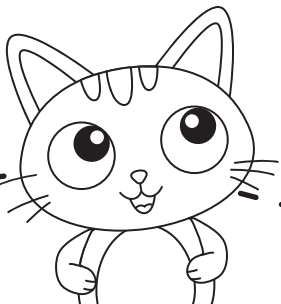

Draw the correct ball

วาดรูปลูกบอลตามประโยคที่กำหนดให้

Example (ตัวอย่าง)

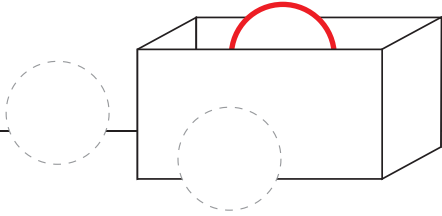

The ball is in the box.

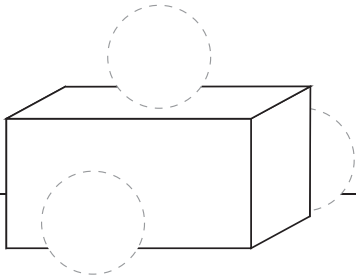

The ball is on the box.

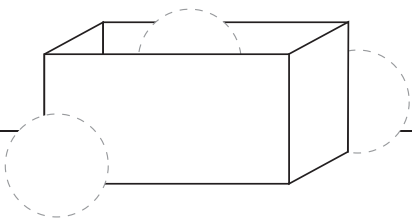

The ball is behind the box.

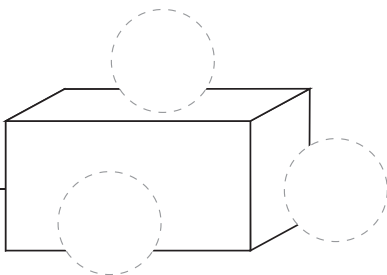

The ball is beside the box.

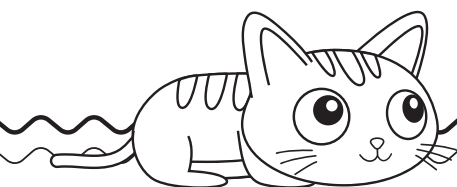

Draw the correct ball

วาดรูปลูกบอลตามประโยคที่กำหนดให้

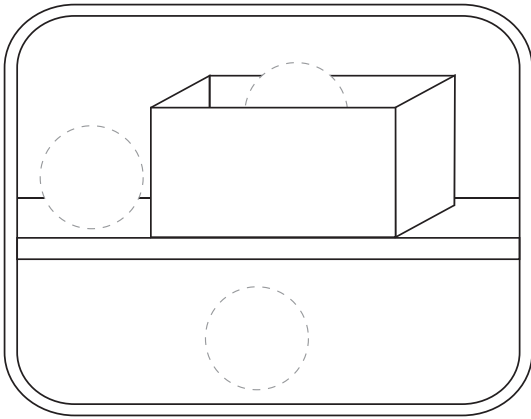

The ball is under the box.

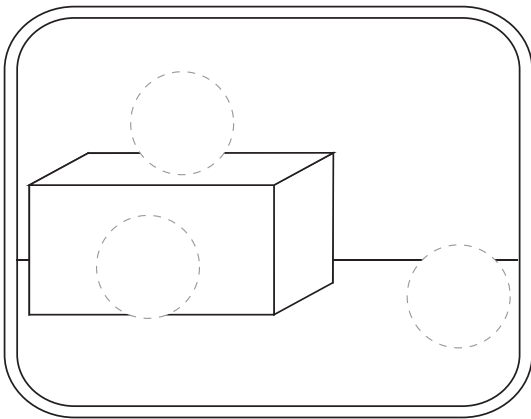

The ball is near the box.

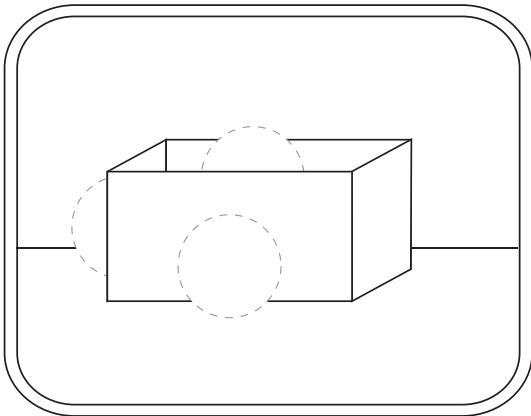

The ball is in front
the box.

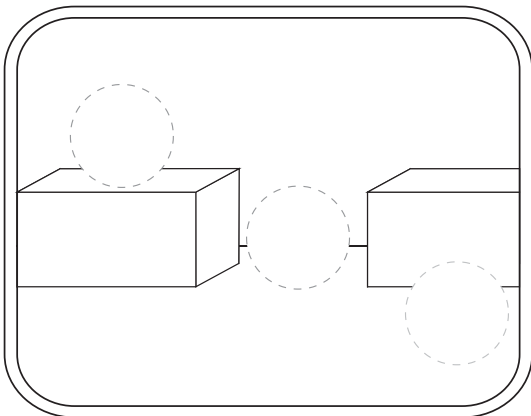

The ball is between
the boxes.

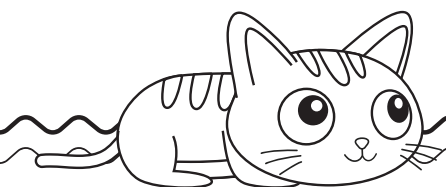

Choose the correct preposition

เลือกคำตอบให้ถูกต้อง

The basketball is _____ the box.

A) on

B) in

C) beside

D) under

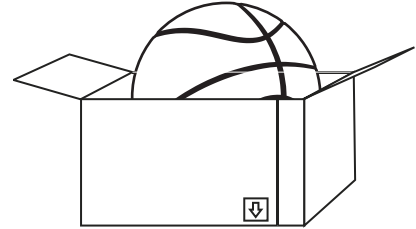

The bear is _____ the drum.

A) in

B) between

C) behind

D) beside

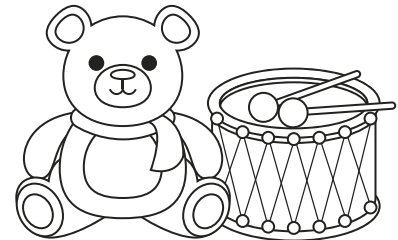

The robot is _____ the chair.

A) under

B) near

C) on

D) in

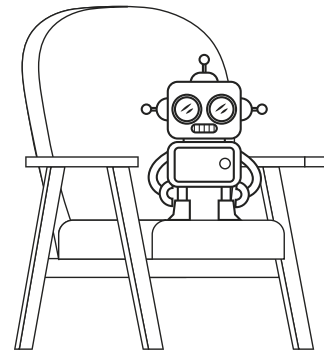

The plate is _____ the fork and the spoon.

A) between

B) on

C) beside

D) behide

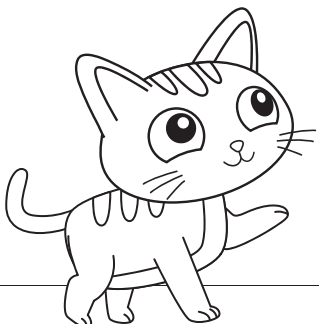
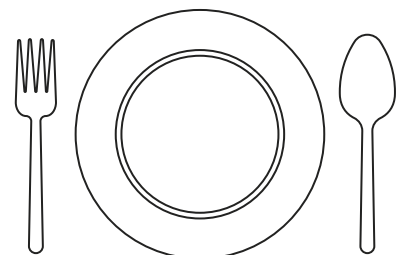

English Style Farang

www.esfworksheets.com

© 2020 All Right Reserved

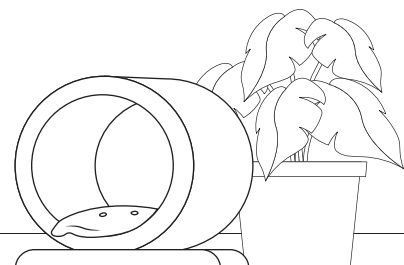

Choose the correct preposition

เลือกคำตอบให้ถูกต้อง

The grape is _____ the bananas.

A) under

B) near

C) in

D) on

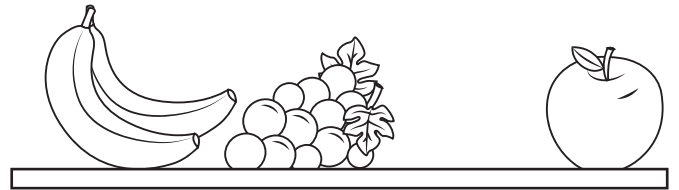

The donut is _____ of the coffee.

A) in front

B) in

C) on

D) beside



The house is _____ the tree.

A) under

B) beside

C) on

D) beside



The dog is _____ the table.

A) between

B) under

C) in

D) in front

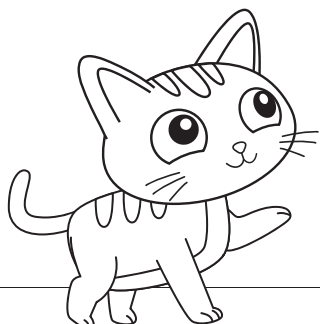
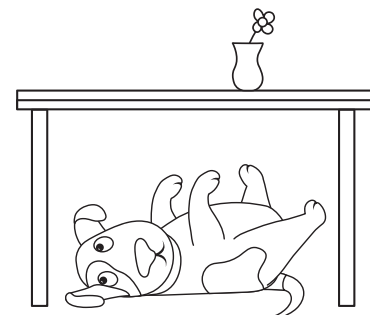

English Style Farang

www.esfworksheets.com

© 2020 All Right Reserved

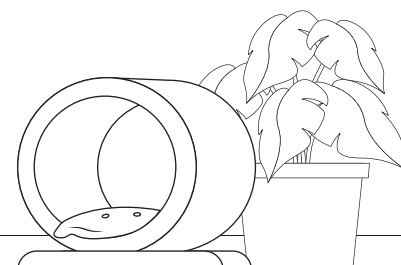

Fill in the blanks with the correct preposition
เติมคำศัพท์ preposition ลงในช่องว่างให้ถูกต้อง

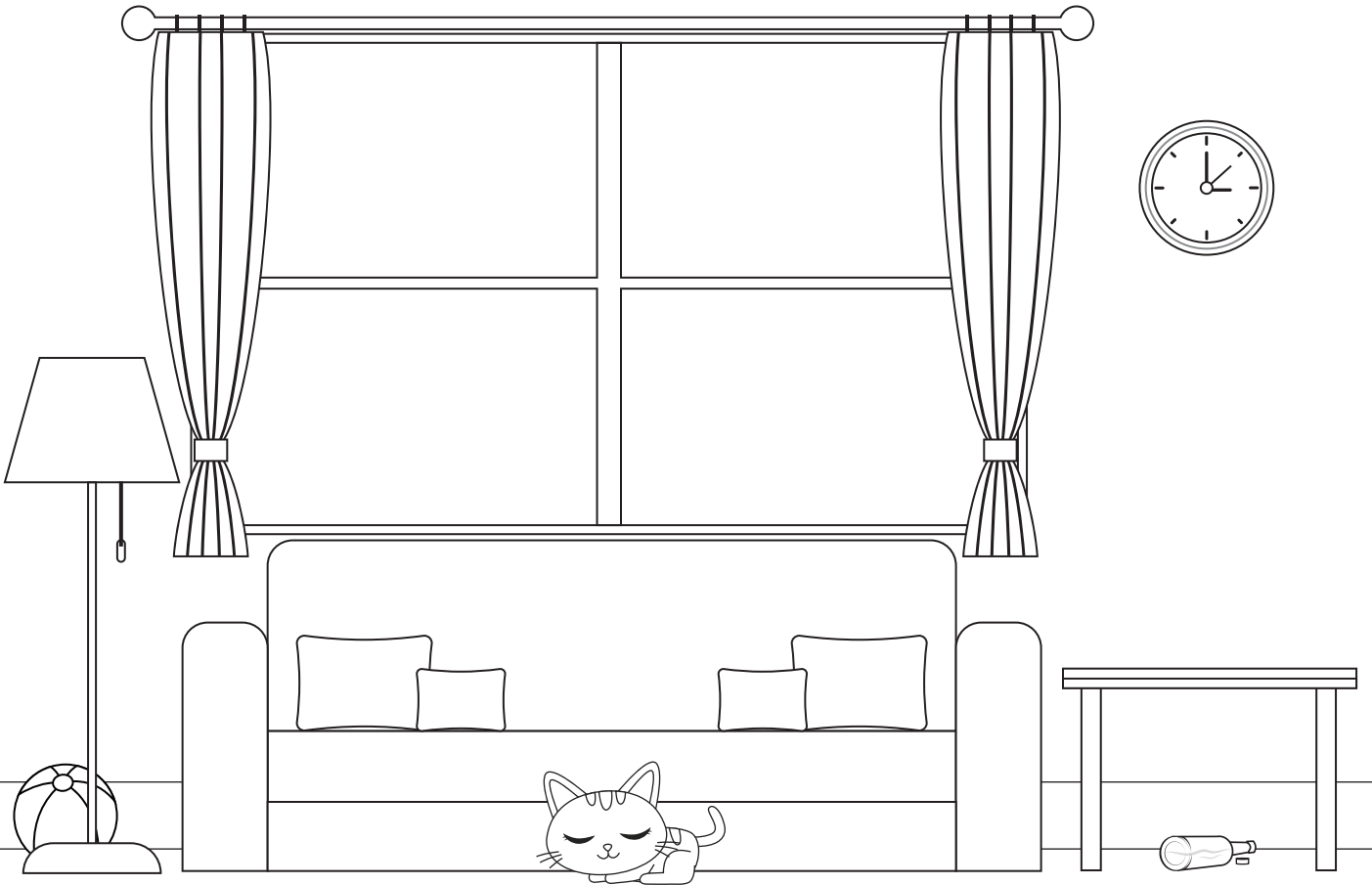

The clock is _____ the wall.

The cat is _____ of the sofa.

The ball is _____ the lamp.

The lamp is _____ the sofa.

The sofa is _____ the lamp
and the table.

The bottle is _____ the table.



www.esfworksheets.com

© 2020 All Right Reserved



Fill in the blanks with the correct preposition
เติมคำศัพท์ preposition ลงในช่องว่างให้ถูกต้อง

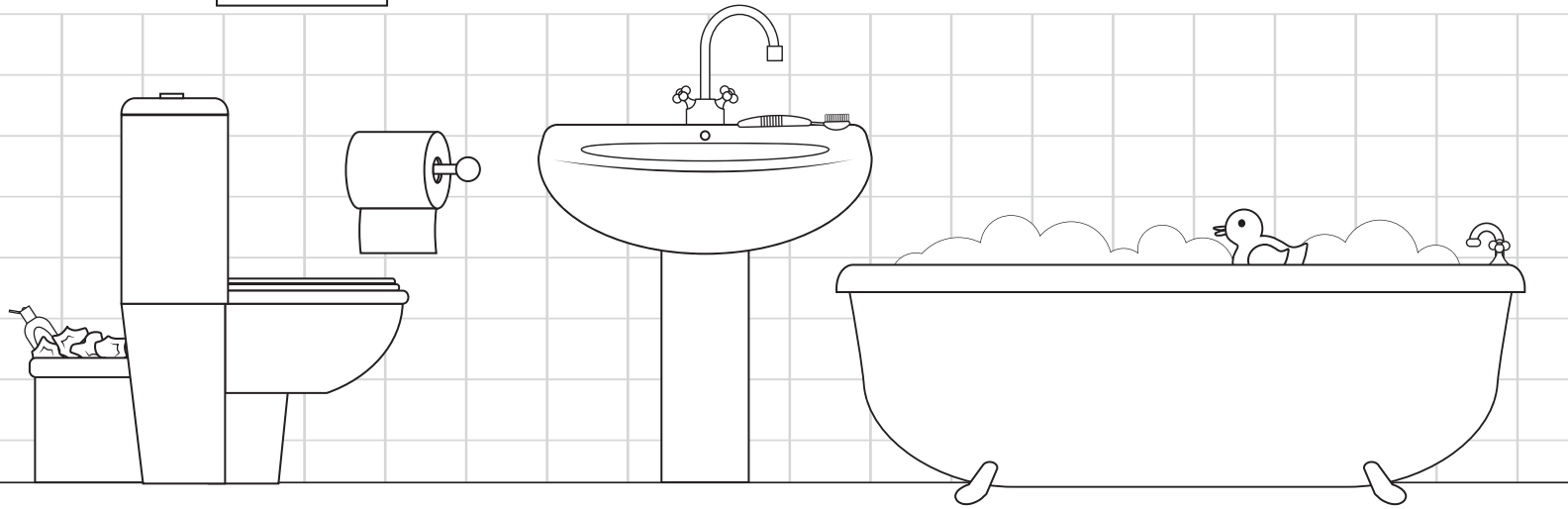
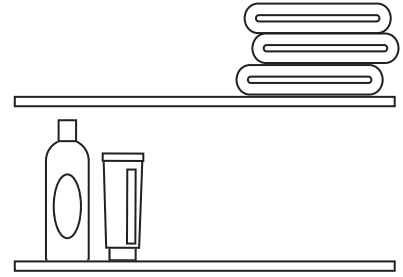
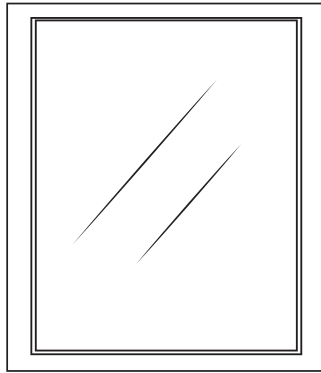
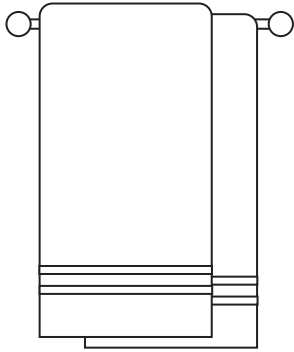

The duck is _____ the bathtub.

The toothbrush is _____ the wash basin.

The toilet is _____ the wash basin.

The trash is _____ the toilet.

The tissue roll is _____ the toilet.

The wash basin is _____ the bathtub
and the toilet.



English Style Farang
www.esfworksheets.com

© 2020 All Right Reserved





Word search ค้นหาคำศัพท์

b	q	o	n	a	i	u	x	e	n
i	e	r	t	i	r	m	y	e	r
t	g	s	z	x	t	h	e	j	a
r	l	e	i	t	o	w	k	q	s
n	n	n	i	d	t	d	h	p	f
m	t	e	o	e	e	u	i	p	y
r	x	a	b	d	n	i	h	e	b
j	x	r	x	d	n	z	e	s	t
k	g	q	e	k	o	c	r	a	j
m	p	r	i	n	f	r	o	n	t

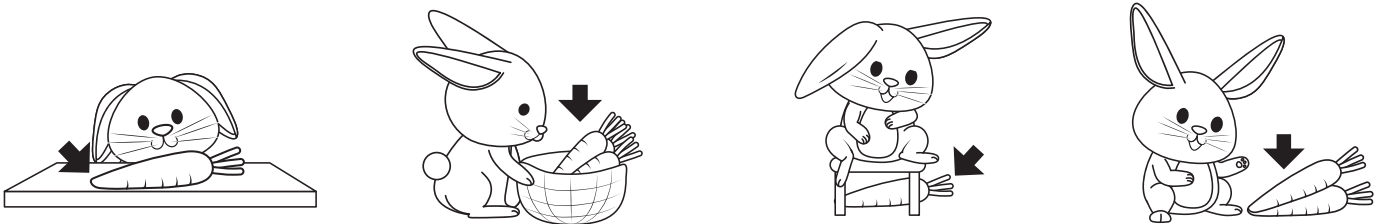
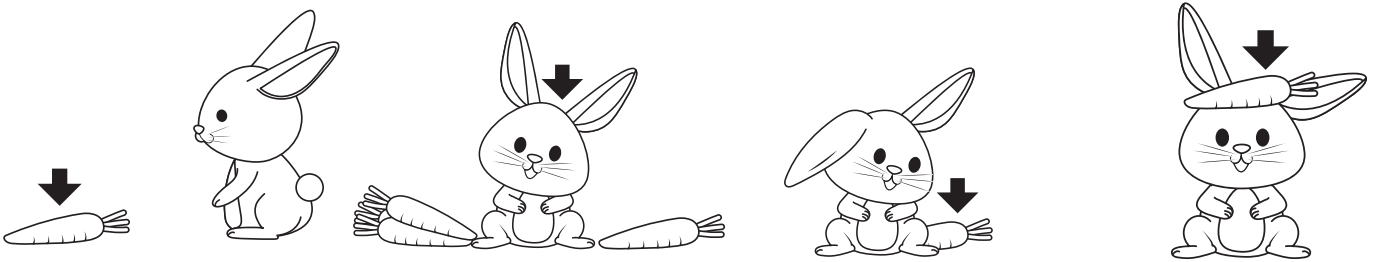

www.esfworksheets.com

© 2020 All Right Reserved



Draw the correct ball

วาดรูปลูกบอลตามประโยคที่กำหนดให้

Example (ตัวอย่าง)

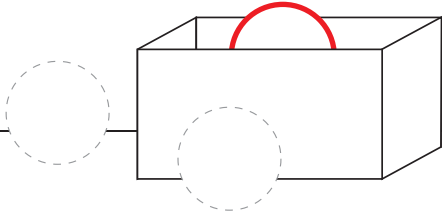

The ball is in the box.

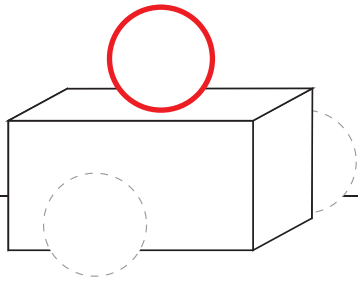

The ball is on the box.

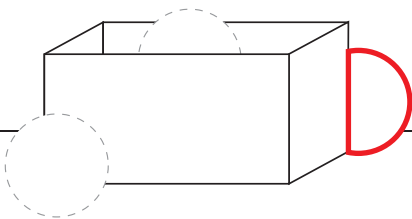

The ball is behind the box.

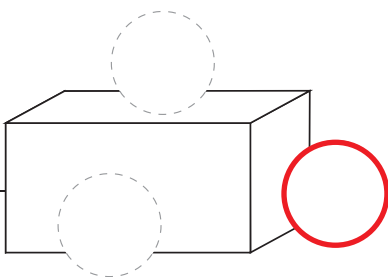

The ball is beside the box.

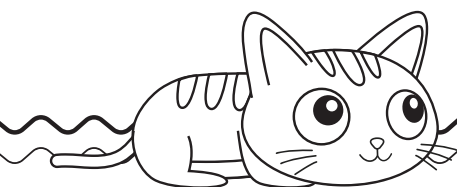

Draw the correct ball

วาดรูปลูกบอลตามประโยคที่กำหนดให้

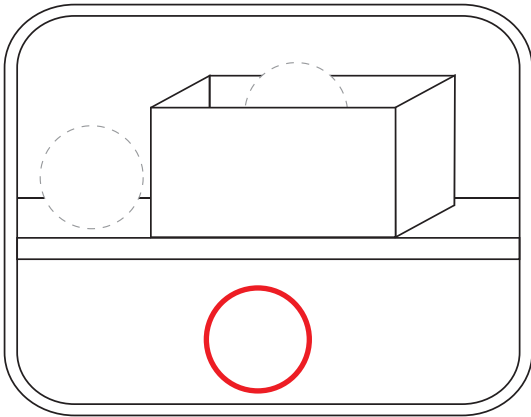

The ball is under the box.

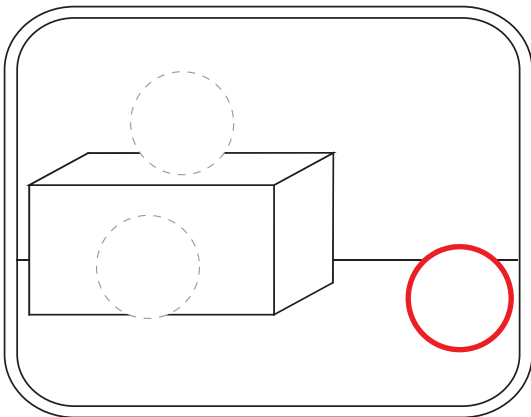

The ball is near the box.

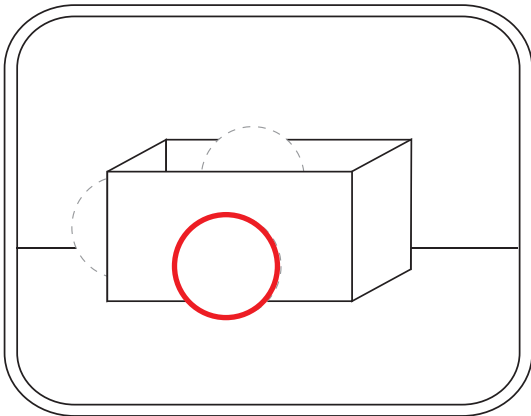

The ball is in front
the box.

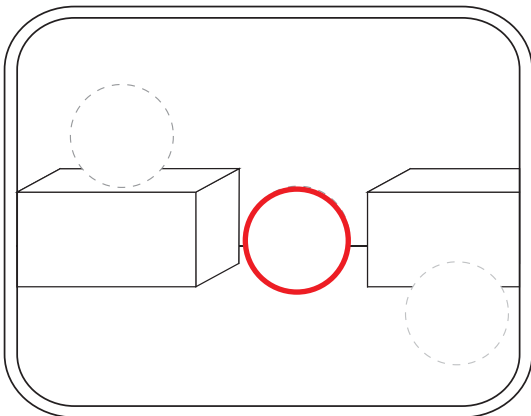

The ball is between
the boxes.

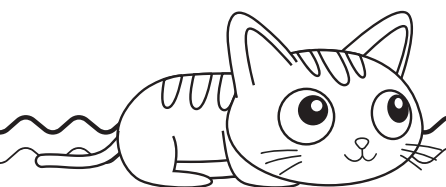

Choose the correct preposition

เลือกคำตอบให้ถูกต้อง

The basketball is _____ the box.

A) on

B) in

C) beside

D) under

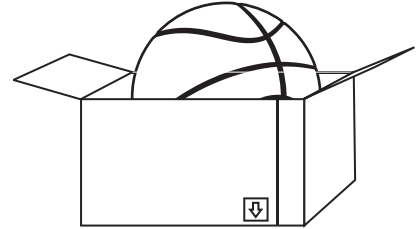

The bear is _____ the drum.

A) in

B) between

C) behind

D) beside

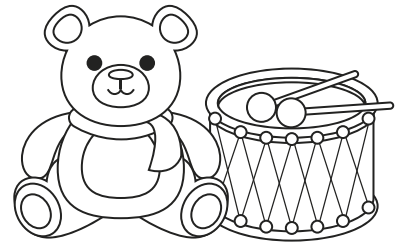

The robot is _____ the chair.

A) under

B) near

C) on

D) in

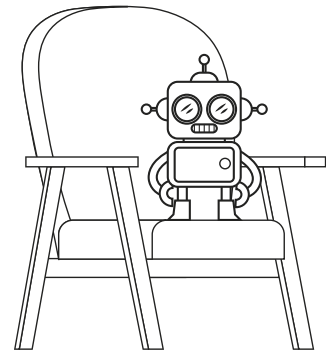

The plate is _____ the fork and the spoon.

A) between

B) on

C) beside

D) behide

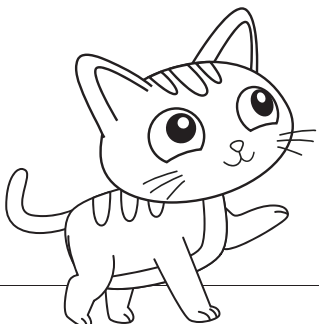
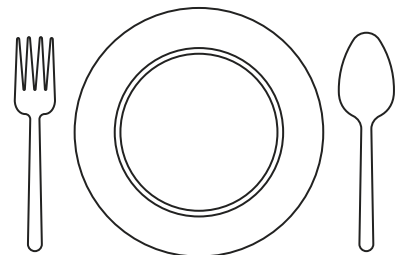

www.esfworksheets.com

© 2020 All Right Reserved

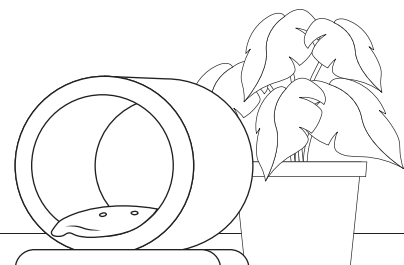

Choose the correct preposition

เลือกคำตอบให้ถูกต้อง

The grape is _____ the bananas.

A) under **B) near**

C) in D) on

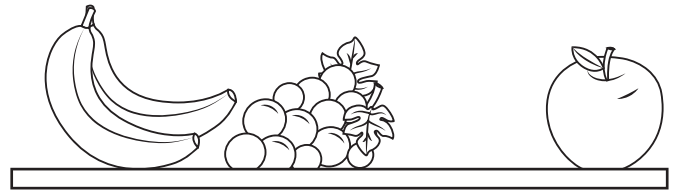

The donut is _____ of the coffee.

A) in front B) in

C) on D) behind

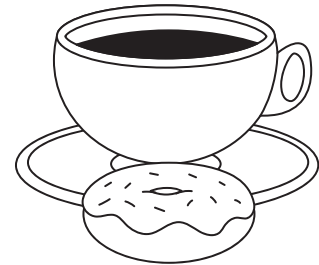

The house is _____ the tree.

A) under B) beside

C) on **D) behind**



The dog is _____ the table.

A) between **B) under**

C) in D) in front

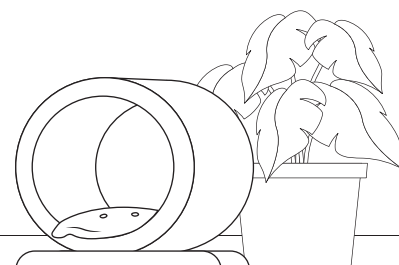
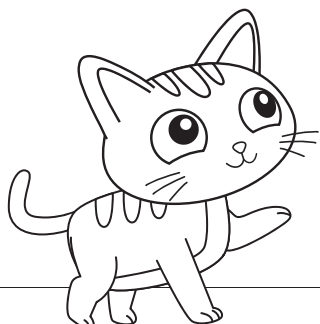
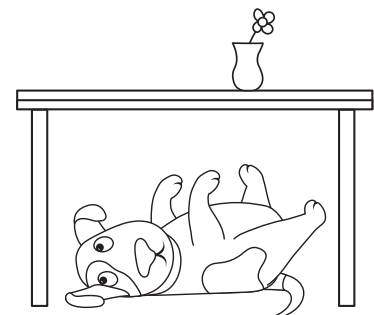

Fill in the blanks with the correct preposition
เติมคำศัพท์ preposition ลงในช่องว่างให้ถูกต้อง

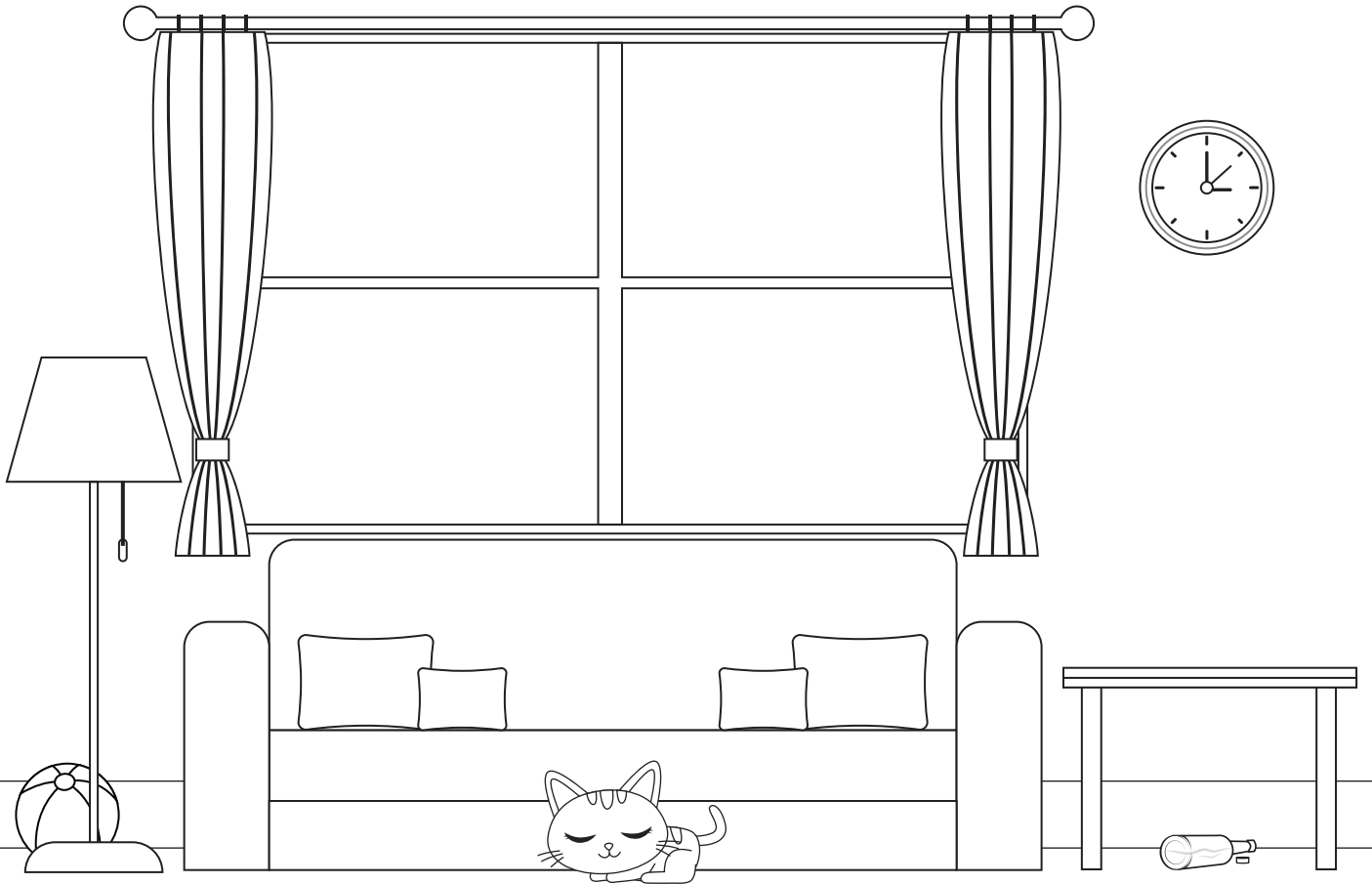

The clock is on the wall.

The cat is in front of the sofa.

The ball is beside the lamp.

The lamp is beside the sofa.

The sofa is between the lamp
and the table.

The bottle is under the table.



English Style Farang

www.esfworksheets.com

© 2020 All Right Reserved



Fill in the blanks with the correct preposition
เติมคำศัพท์ preposition ลงในช่องว่างให้ถูกต้อง

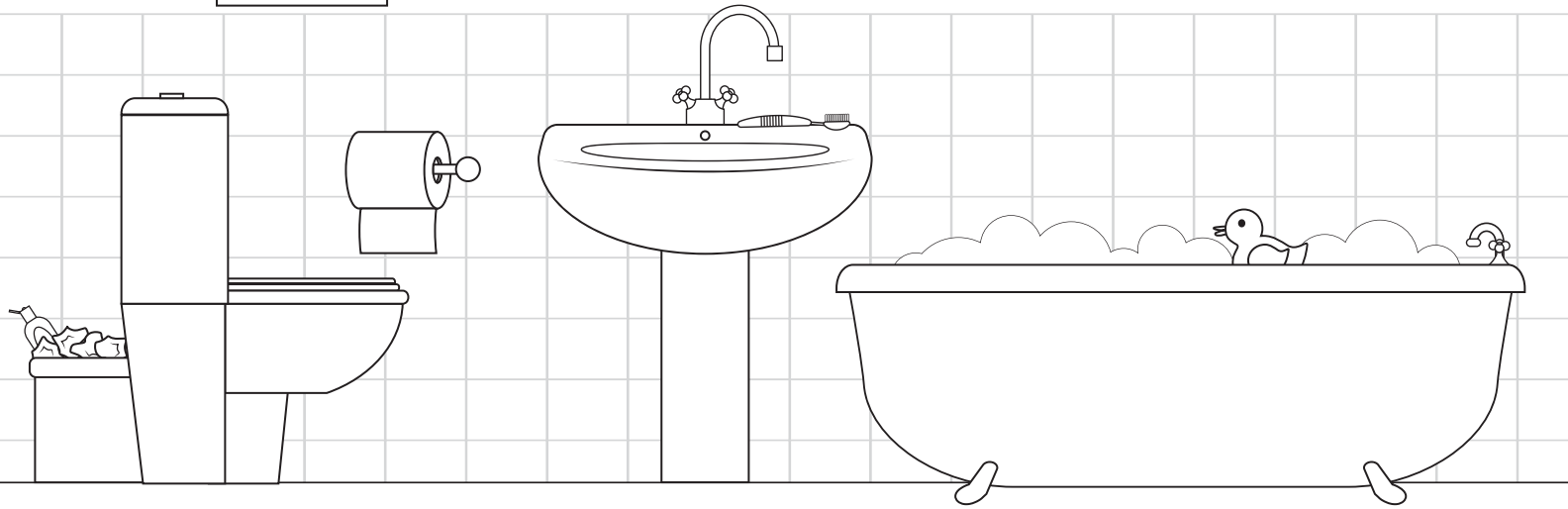
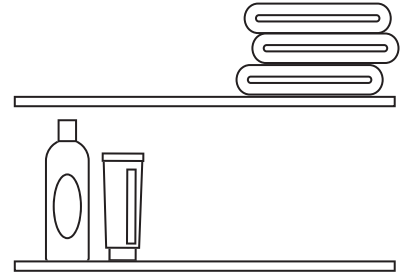
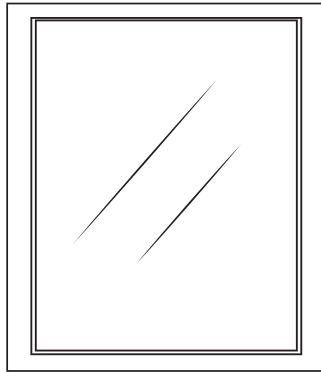
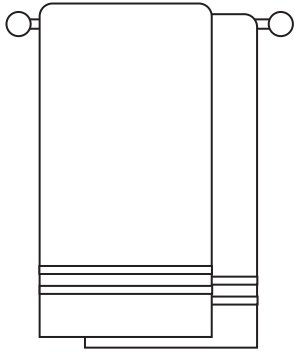

The duck is in the bathtub.

The toothbrush is on the wash basin.

The toilet is beside the wash basin.

The trash is behind the toilet.

The tissue roll is near the toilet.

The wash basin is between the bathtub and the toilet.



English Style Farang
www.esfworksheets.com

© 2020 All Right Reserved





Word search ค้นหาคำศัพท์

b	q	o	n	a	i	u	x	e	n
i	e	r	t	i	r	m	y	e	r
t	g	s	z	x	t	h	e	j	a
r	l	e	i	t	o	w	k	q	s
n	n	n	i	d	t	d	h	p	f
m	t	e	o	e	e	u	i	p	y
r	x	a	b	d	n	i	h	e	b
j	x	r	x	d	n	z	e	s	t
k	g	q	e	k	o	c	r	a	j
m	p	r	i	n	f	r	o	n	t

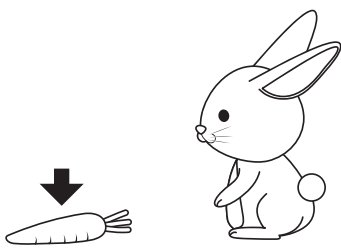

near

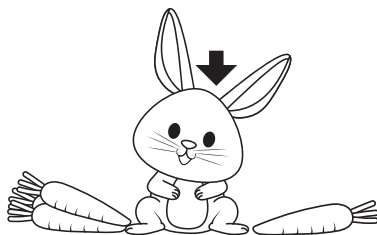

between

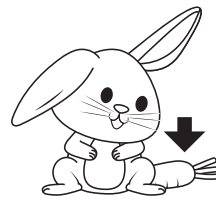

behind

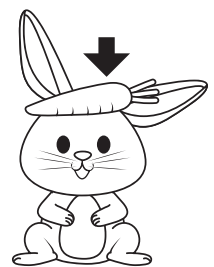

on



in front

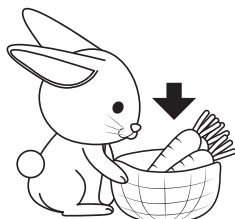

in

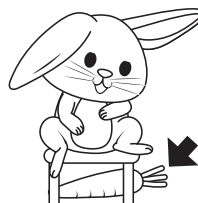

under

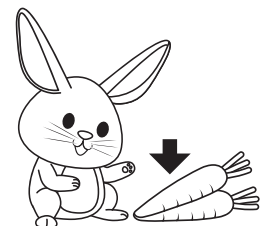

beside

